



3M Science.
Applied to Life.™

Electrical Utilities

Personal Protective Equipment Catalog

Fall 2016

United States

From the top down, we've got you covered.

1

2

3

4

5

Thousands of volts of electricity. 40 feet off the ground. Sound familiar?

Electrical utility work is never easy, but it should be safe. At 3M, we proactively innovate personal protection products that tackle the many unique challenges of the electrical industries. Our complete portfolio includes everything from the earplugs up to arc flash rated full-body harnesses and more.

3M
Empowering
Material

Safety starts with knowledge.

World-class training facilities. Customized on-site classes. Online eLearning courses. No matter the location or level of training needed, 3M Fall Protection combines engaging information with practical, hands-on experience in a wide range of applications for electrical utility workers. Every course we offer meets industry standards set by OSHA, MSHA, ANSI, CSA and CE.

Meeting standards for safety. Exceeding them for comfort.

Comfort. Ease of use. Durability. These are all important qualities that we infuse into every safety product we engineer. But above all else, they have to be safe and reliable. That's why we rigorously test all of our products to meet applicable standards around the world. Our ISO 9001-2008 certification and onsite ISO 17025 accredited lab demonstrates our commitment to quality and safety to best serve electrical utilities industries.

Table of contents

	PAGE NO.
1 Head and Face Protection	4-5
2 Eye Protection	6-9
3 Hearing Protection	10-13
Foam-Style Earplugs	10-11
Push-to-Fit Style Earplugs	11-12
Washable/Reusable Push-to-Fit Style Earplugs	12-13
Earmuffs	13
4 Breathing Protection	14-19
Reusable Respirators	14-16
Disposable Respirators	16-17
Powered and Supplied Air	18-19
5 Fall Protection	20-41
Cynch-Lok™ Fall Restricting Devices	21-22
Belts and Harnesses	22-25
Shock-Absorbing Lanyards	26-27
Self-Retracting Lifelines	28-29
Fall Protection for Tools	30-32
Systems	33-36
Rescue Solutions	37-41
UPC and Part Number Index	42-43

For Personal Protective Equipment support:

3M.com/PPESafety
Customer Service: 800-328-1667
Technical Service: 800-243-4630

For Fall Protection support:

3M.com/FallProtection
800-328-6146 (Opt. 1)
3MFallProtection@mmm.com

Head and Face Protection

Comfortably provide limited head protection from small falling objects striking the top of the hard hat. With a wide variety of styles, fits and colors—engineered to meet the rigorous standards of the electrical utilities industry—we have head and face protection solutions for a variety of applications.



3M™ Headgear/Faceshield

A complete headgear and faceshield safety system, this high-strength thermoplastic hard hat helps provide durable impact resistance and reliable head and face protection. Adjustable ratchet suspension. A more chemical resistant propionate option is also available.

UPC #	Part #	Description
10-078371-82782-0	82782-00000	3M™ Ratchet Headgear H8A, 82782-00000, with 3M™ Clear Propionate Faceshield W96 5 EA/Case
10-078371-82501-7	82501-00000	3M™ Ratchet Headgear H8A, 82501-00000 10 EA/Case
10-078371-82502-4	82502-00000	3M™ Cap Mount Hard Hat Headgear H18, 82502-00000 10 EA/Case
10-078371-82701-1	82701-00000	3M™ Clear Polycarbonate Faceshield WP96, 82701-00000, Molded 10 EA/Case
10-078371-11872-0	82520-10000	3M™ Universal Headgear For Hard Hat H24M 82520-10000 20 EA/Case



*All meet ANSI Z87.1-2003 standard.

3M™ Hard Hat, H-700 Series, 4-Point Ratchet Suspension

Protective hard hat with comfortable 4-point ratchet suspension and standard brow pad. Available in 13 colors (see below for ordering information). Non-vented H-700 hard hats meet requirements of ANSI/ISEA Z89.1-2009 Type 1, Class G and E.

UPC #	Part #	Description
10-078371-64197-6	H-701R	3M™ Hard Hat H-701R, White 4-Point Ratchet Suspension, 20 EA/Case



3M™ Hard Hat, H-700 Series, with 3M™ Uvicator™ Sensor

This award-winning, lightweight hard hat offers comfort and protection, and also features a Uvicator sensor that changes color as the hard hat is exposed to UV light. Available in 13 colors (see below for ordering information).

UPC #	Part #	Description
10-078371-65550-8	H-701R-UV	3M™ Hard Hat with Uvicator™ Sensor H-701R-UV, White, 4-Point Ratchet Suspension, 20 EA/Case
10-007837-16555-5	H-702R-UV	3M™ Hard Hat with Uvicator™ Sensor H-702R-UV, Yellow, 4-Point Ratchet Suspension, 20 EA/Case



H-701R-UV

H-702R-UV

3M™ Full Brim Hard Hat, H-800 Series

Protective full brim hard hat with comfortable 4-point ratchet suspension and standard brow pad and 3M™ Uvicator™ Sensor. Available in 13 colors (see below for ordering information). Non-vented H-800 hard hats meet requirements of ANSI/ISEA Z89.1-2009 Type 1, Class G and E.

UPC #	Part #	Description
10-007837-16579-7	H-801R-UV	3M™ Full Brim Hard Hat H-801R-UV, White 4-Point Ratchet Suspension, with Uvicator™ Sensor, 20 EA/Case
10-007837-16579-4	H-802R-UV	3M™ Full Brim Hard Hat H-802R-UV, Yellow 4-Point Ratchet Suspension, with Uvicator™ Sensor, 20 EA/Case



3M™ Hard Hat Task Light

Lightweight, 4 LED, 70 lumen, task light with 4 lighting modes that can be worn with 3M hard hats. Weighing only about 78 grams, but able to run up to 150hrs on low setting and 74hrs on its high setting, this water resistant (IPX-4 rated) hard hat mounted head lamp is popular in a wide range of industrial lighting applications. Comes with 3 AAA batteries and three attachment options.

UPC #	Part #	Description
50-051131-27566-4	HL100	3M™ Hard Hat 70 Lumen Task Light, HL100, 10 EA/Case
50-051131-27567-1	HL200	3M™ Hard Hat 150 Lumen Task Light, HL200, 10 EA/Case
50-051131-27568-8	HL300IS	3M™ Hard Hat 150 Lumen, Intrinsically Safe Task Light, HL300IS, 10 EA/Case



HL100

HL200

HL300IS

Fitted to your head and your style.

Select H-700 or H-800 Series Hard Hats in any of 13 available colors.



Visit www.hardhatcustomizer.3M.com to add a custom logo or adding 3M™ Scotchlite™ Reflective stickers.



Eye Protection

Protect your eyes without sacrificing comfort or style. Eye injuries on the job are the result of either not wearing eye protection or wearing the wrong kind. With a variety of protective eyewear options—from LED equipped frames to antifog or anti-scratch lenses—we have solutions to enhance your safety in virtually any application.

3M™ SecureFit™ Protective Eyewear, 400 Series

3M™ SecureFit™ 400 Series features soft adjustable nose pads, dual injected temples, and proprietary 3M™ Pressure Diffusion Temple Technology that helps diffuse pressure over the ear to enhance frame comfort while not compromising the security of fit across a diverse workforce.

UPC #	Part #	Description
10-007837-16621-7	SF401AF	3M™ SecureFit™ Protective Eyewear SF401AF, Clear Anti-fog Lens, 20 EA/Case
10-007837-16621-4	SF402AF	3M™ SecureFit™ Protective Eyewear SF402AF, Gray Anti-fog Lens, 20 EA/Case



3M™ SecureFit™ Protective Eyewear, 200 Series

Stylish, lightweight design weighs less than 1oz. Features proprietary 3M™ Pressure Diffusion Temple Technology that helps diffuse pressure over the ear to enhance frame comfort while not compromising the security of fit across a diverse workforce.

UPC #	Part #	Description
10-007837-16571-5	SF201AF	3M™ SecureFit™ Protective Eyewear SF201AF, Clear Lens, 20 EA/Case
10-007837-16571-2	SF202AF	3M™ SecureFit™ Protective Eyewear SF202AF, Gray Lens, 20 EA/Case



3M™ Light Vision™ 2 Protective Eyewear

An illuminating choice for detailed indoor or outdoor work, LightVision protective eyewear features adjustable, hands-free LED lights, while its high wrap lens offers additional coverage. This hands-free lighting solution is also available in magnifying diopters.

UPC #	Part #	Description
10-007837-16211-4	11476-00000-10	3M™ Light Vision™ 2 Protective Eyewear 11476-00000-10 Clear Anti-Fog Lens, Gray Frame, Lights 10 EA/Case
10-007837-16211-1	11477-00000-10	3M™ Light Vision™ 2 Protective Eyewear 11477-00000-10 Clear Anti-Fog Lens,, Gray Frame, +1.5 Diopt 10 EA/Case
10-007837-16211-8	11478-00000-10	3M™ Light Vision™ 2 Protective Eyewear 11478-00000-10 Clear Anti-Fog Lens,, Gray Frame, +2.0 Diopt 10 EA/Case



All meet ANSI Z87.1-2010 and CSA Z94.3 standards.

3M™ BX™ Protective Eyewear

Sleek, contoured and fully adjustable protective eyewear, 3M™ BX™ Eyewear features a soft adjustable nose bridge, lens angle adjustment, and adjustable length temples for extended wear. Optional models designed for workers who have difficulty reading small print or are engaged in small detail work. BX protective reader eyewear features magnifying diopters, lightweight lenses with adjustable soft tip temples and integrated sideshields.

UPC #	Part #	Description
10-007837-16205-0	11380-00000-20	3M™ BX™ Protective Eyewear 11380-00000-20 Clear Anti-Fog Lens, Silver/Black Frame 20 EA/Case
10-007837-16204-9	11374-00000-20	3M™ BX™ Reader Protective Eyewear 11374-00000-20 Clear Lens, Silver Frame, +1.5 Diopter 20 EA/Case
10-007837-16204-6	11375-00000-20	3M™ BX™ Reader Protective Eyewear 11375-00000-20 Clear Lens, Silver Frame, +2.0 Diopter 20 EA/Case



3M™ Virtua™ CCS Protective Eyewear with Foam Gasket

Comfortable, lightweight frame features the Cord Control System (CCS) with optional foam gasket attachment. Meets the requirements of CSA Z94.3-07 and is Impact Rated to ANSI Z87.1-2010.

UPC #	Part #	Description
100-78371-11872-0	11872-00000-20	3M™ Virtua™ CCS Protective Eyewear w/Foam Gasket, Clear Anti-Fog Lens
100-78371-11873-7	11873-00000-20	3M™ Virtua™ CCS Protective Eyewear w/Foam Gasket, Gray Anti-Fog Lens
100-78371-11874-4	11874-00000-20	3M™ Virtua™ CCS Protective Eyewear w/Foam Gasket, Indoor/Outdoor Mirrored Anti-Fog Lens



All 3M plano eyewear listed meets ANSI Z87.1 Impact standard.

3M™ Maxim™ Protective Eyewear

Lightweight Maxim protective eyewear is both stylish and durable, featuring adjustable temples and nose bridge, a cushioned browguard and a ventilation channel designed to help prevent fogging and vent heat away from the face.

3M™ Maxim™ GT Protective Eyewear

Lightweight Maxim GT protective eyewear features an elastomeric browguard, a high-wrap lens and anti-fog coating for indoor or outdoor use. Dual-injected adjustable temples with 3-position lens adjustment helps wearer achieve a better fit.

UPC #	Part #	Description
10-007837-16223-7	13250-00000-20	3M™ Maxim™ Protective Eyewear Black Adjustable Temple Clear Lens
10-007837-16261-6	14246-00000-20	3M™ Maxim™ Protective Eyewear GT Clear ST A/F Lens, Silver/Gray & Black Frame



3M™ Smart Lens™ Photochromic Eyewear

Photochromic SmartLens protective eyewear, featuring transitional, abrasion-resistant polycarbonate lenses, and a soft adjustable nose bridge, nylon brow and magnesium alloy spring-hinged temple for a flexible fit.

UPC #	Part #	Description
10-007837-16203-9	13407-00000-5	3M™ Smart Lens™ Protective Eyewear 13407-00000-5 Photochromatic Lens, Black Frame 5 EA/Case



3M™ Virtua™ AP Protective Eyewear

Virtua AP protective eyewear offers sleek, unisex styling, lightweight comfort and exceptional value. It is designed with high-wrap polycarbonate lenses and integral sideshields to provide comfort with protection.

3M™ Virtua™ Protective Eyewear, Clear Anti-Fog Lens

Lightweight, unisex Virtua protective eyewear combines versatility and value with high wraparound coverage, polycarbonate construction and a hard coat, scratch-resistant lens for a comfortable, contoured fit.

3M™ Virtua™ Protective Eyewear, Clear Anti-Fog Lens

Comfortable, lightweight frame features the Cord Control System (CCS) with optional foam gasket attachment. Meets the requirements of CSA Z94.3-07 and is Impact Rated to ANSI Z87.1-2010.

UPC #	Part #	Description
10-007837-11181-8	11818-00000-20	3M™ Virtua™ AP Protective Eyewear 11818-00000-20, Clear Anti-Fog Lens, 20 EA/Case
10-007837-16210-3	11329-00000-20	3M™ Virtua™ Protective Eyewear 11329-00000-20 Clear Anti-Fog Lens, Clear Temple 20 EA/Case
10-007837-16210-6	11329-00000-100	3M™ Virtua™ Protective Eyewear 11329-00000-100 Clear Temples Clear Anti-Fog Lens, 100 EA/Case
10-007837-11187-0	11872-00000-20	3M™ Virtua™ CCS Protective Eyewear 11872-00000-20, with Foam Gasket, CLEAR Anti-Fog Lens, 20 EA/Case



3M™ Solus™ Protective Eyewear, 1000 Series

3M™ Solus™ 1000 series protective eyewear features 3M™ Scotchgard™ Anti-Fog Lens Coating which helps workers see clearly, longer – providing longer lasting fog resistance than traditional anti-fog coatings. Removable temples enable the use of the optional strap. Optional foam gasket helps reduce eye exposure. Available in several frame colors and lens tints.

UPC #	Part #	Description
50-005113-12718-6	S1201SGAF	3M™ Solus™ 1000-Series, S1201SGAF, Green/Black, Clear Scotchgard™ Anti-fog lens 20 EA/Case
50-005113-12718-3	S1202SGAF	3M™ Solus™ 1000-Series S1202SGAF, Green/Black, Grey Scotchgard™ Anti-fog Lens 20 EA/Case



3M™ Fuel™ Protective Eyewear

Empower your vision with Fuel protective safety eyewear. Constructed with a durable nylon frame, polycarbonate lens, color-accented vented temples and a scratch-resistant lens coating. Soft touch nose bridge and temple tips help add comfort.

UPC #	Part #	Description
10-007837-16214-3	11640-00000-10	3M™ Fuel™ Protective Eyewear 11640-00000-10 Red Mirror Lens, Metallic Sand Frame 10 EA/Case



3M™ Moon Dawg™ Protective Eyewear

Surf-inspired Moon Dawg safety glasses are your comfortable, stylish choice for protective eyewear. Its lightweight, wide temple frame offers enhanced coverage, and its durable construction makes it a cool outdoor safety sunwear option on the job.

UPC #	Part #	Description
10-007837-16217-7	11215-00000-20	3M™ Moon Dawg™ Protective Eyewear 11215-00000-20 Gray Anti-Fog Lens, Black Frame 20 EA/Case
10-007837-16217-4	11216-00000-20	3M™ Moon Dawg™ Protective Eyewear 11216-00000-20 I/O Mirror Lens, Black Frame 20 EA/Case



3M™ Integrated Protective Eyewear

This integrated lightweight retractable eyewear is easy to attach to the headband of 3M hard hats. Available in amber, gray and clear lenses.

UPC #	Part #	Description
10-007837-16674-3	HIE601AF	3M™ Integrated Protective Eyewear HIE601AF Clear Anti-fog Lens, 20 EA/Case
10-007837-16674-0	HIE602AF	3M™ Integrated Protective Eyewear HIE602AF Amber Anti-fog Lens, 20 EA/Case
10-007837-16674-7	HIE603AF	3M™ Integrated Protective Eyewear HIE603AF Gray Anti-fog Lens, 20 EA/Case



All 3M plano eyewear listed meets ANSI Z87.1 Impact standard.

Hearing Protection

Twenty-two million workers are exposed to potentially damaging noise at work each year¹. We provide lightweight, comfortable and easy-to-use hearing protection products to help protect workers' hearing on the job. Our solutions fit a wide variety of preferences for electrical utility environments.

¹[osha.gov/SLTC/noisehearingconservation/index.html](https://www.osha.gov/SLTC/noisehearingconservation/index.html)



Foam-Style Earplugs

3M™ E-A-R™ Classic™ Uncorded Foam Earplugs – Arc-Flash Tested**

3M™ E-A-R™ Classic™ Uncorded Earplugs set the standard in hearing protection as the world's first foam earplugs. Constructed from slow-recovery foam, the disposable earplug comes in a clean, convenient pillow pack.

UPC #	Part #	Description	Noise Reduction Rating (NRR)*
10-008052-91000-6	310-1001	3M™ E-A-R™ Classic™ Uncorded Earplugs 310-1001, in Pillow Pack 2000 EA/Case	29 dB. CSA Class AL
10-008052-91005-8	310-1101	3M™ E-A-R™ Classic™ Plus Uncorded Earplugs 310-1101, in Pillow Pack 2000 EA/Case	29 dB. CSA Class AL



3M™ Foam Earplugs 1100, Uncorded

3M™ 1100 Uncorded Foam Earplugs feature soft, hypoallergenic foam and a tapered design to insert comfortably in the ear canal.

UPC #	Part #	Description	Noise Reduction Rating (NRR)*
50-005113-82900-0	1100	3M™ Uncorded Foam Earplugs 1100 1000 EA/Case	29 dB. CSA Class AL



**3M E-A-R Classic earplugs did not ignite when tested under simulated arc-flash conditions up to 24 cal/cm².

3M™ E-A-Rsoft™ Yellow Neons™ Corded Earplugs

3M™ E-A-Rsoft™ Yellow Neons™ Corded Earplugs seal the ear canal with soft, slow-recovery foam for excellent noise reduction and comfort. Large size E-A-Rsoft earplugs are intended for persons with larger ear canals.

UPC #	Part #	Description	Noise Reduction Rating (NRR)*
10-008052-91103-0	311-1251	3M™ E-A-Rsoft™ Yellow Neons™ Corded Earplugs 311-1251, Large, in Poly Bag Large Size 2000 EA/Case	33 dB. CSA Class AL



3M™ E-A-Rsoft™ SuperFit™ Corded Earplugs

E-A-Rsoft corded foam earplugs seal the ear canal with soft, slow-recovery foam for excellent noise reduction and reliable hearing protection. Orange fitting ring provides a guideline for proper insertion and visual compliance check.

UPC #	Part #	Description	Noise Reduction Rating (NRR)*
10-008052-91105-3	311-1254	3M™ E-A-Rsoft™ SuperFit™ Corded Earplugs 311-1254, in Poly Bag Regular Size 2000 EA/Case	33 dB. CSA Class AL



3M™ E-A-Rsoft™ Yellow Neon™ Blasts™ Corded Earplugs

3M™ E-A-Rsoft™ Yellow Neon Blasts™ Corded Earplugs seal the ear canal with soft, slow-recovery foam for excellent noise reduction and comfort.

UPC #	Part #	Description	Noise Reduction Rating (NRR)*
10-008052-91103-7	311-1252	3M™ E-A-Rsoft™ Yellow Neons™ Blasts™ Corded Earplugs 311-1252, in Poly Bag Regular Size 2000 EA/Case	33 dB. CSA Class AL



3M™ E-A-R™ TaperFit™ 2 Regular Corded Earplugs

3M™ E-A-R™ TaperFit™ 2 Corded Earplugs help provide a comfortable, individualized fit and excellent attenuation. Its smooth foam expands in the ear canal to help provide comfortable hearing protection.

UPC #	Part #	Description	Noise Reduction Rating (NRR)*
10-008052-91201-2	312-1223	3M™ E-A-R™ TaperFit™ 2 Corded Earplugs 312-1223, Regular 2000 EA/Case	32 dB. CSA Class AL



**3M strongly recommends fit testing of hearing protectors. Research suggests that many users will receive less noise reduction than indicated by the NRR due to variation in earmuff fit, earmuff fitting skill and motivation of the user. If the NRR is used to estimate typical workplace protection, 3M recommends that the NRR be reduced by 50% or in accordance with applicable regulations.*

Push-to-Fit Style Earplugs

3M™ Skull Screws™ Corded Earplugs

3M™ Skull Screws™ Corded Earplugs sport the tough look of threaded metal, but feel of soft foam, while offering push-to-fit convenience and noise attenuation with attitude. Effective hearing protection and compliance with a clean, easy twist.

UPC #	Part #	Description	Noise Reduction Rating (NRR)*
10-009304-59295-5	P1301	3M™ E-A-R™ Skull Screws™ Corded Earplugs P1301 480 EA/Case	32 dB. CSA Class AL



3M™ E-A-R™ Push-Ins Corded Earplugs

No roll down is required; a gentle push is all it takes for easy, consistent insertion. The unique, soft 3M™ E-A-Rform™ Foam tip is designed to mold comfortably to fit a wide range of ear sizes.

UPC #	Part #	Description	Noise Reduction Rating (NRR)*
10-008052-91800-5	318-1001	3M™ E-A-R™ Push-Ins™ Corded Earplugs 318-1001, in Poly Bag 400 EA/Case	28 dB. CSA Class AL



3M™ E-A-R™ Push-Ins with Grip Rings Corded Earplugs

3M™ E-A-R™ Push-Ins™ with patented Grip Rings corded push-to-fit foam earplugs gently enter the ear canal to enhance fit.

UPC #	Part #	Description	Noise Reduction Rating (NRR)*
10-008052-91801-4	318-1009	3M™ E-A-R™ Push-Ins™ with Grip Rings Corded Earplugs 318-1009, in Poly Bag 2000 EA/Case	30 dB. CSA Class AL



3M™ E-A-R™ EXPRESS™ Pod Plugs™ with Assorted Grips

3M™ E-A-R™ EXPRESS™ Pod Plugs™ push-to-fit earplugs feature advanced “no-roll”, slow-recovery foam tips and assorted, paddle-style color grips. Unique grips allow easy use and help keep earplug tips clean even when your hands are dirty.

UPC #	Part #	Description	Noise Reduction Rating (NRR)*
10-008052-92101-8	321-2200	3M™ E-A-R™ EXPRESS™ Pod Plugs™ Uncorded Earplugs Assorted Color Grips 321-2200, in Pillow Pack 400 EA/Case	25 dB. CSA Class AL
10-008052-91101-1	311-1115	3M™ E-A-R™ EXPRESS™ Pod Plugs™ Corded Earplugs Assorted Color Grips 311-1115, in Pillow Pack 400 EA/Case	25 dB. CSA Class AL

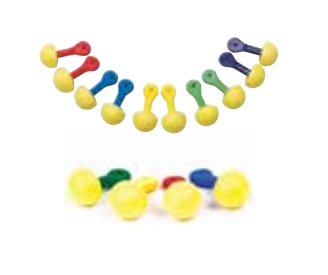

Washable/Reusable Plugs

3M™ E-A-R™ UltraFit™ Corded Earplugs

The 3M™ E-A-R™ UltraFit™ Corded Earplugs features a proven triple-flange design and soft, premolded material that can be used again and again.

UPC #	Part #	Description	Noise Reduction Rating (NRR)*
10-008052-94000-8	340-4004	3M™ E-A-R™ UltraFit™ Corded Earplugs 340-4004, in Poly Bag, 400 EA/Case	25 dB. CSA Class AL
10-008052-94000-4	340-4002	3M™ E-A-R™ UltraFit™ Corded Earplugs 340-4002, in Carrying Case 200 EA/Case	25 dB. CSA Class AL



3M™ E-A-R™ UltraFit Plus™ Corded Earplugs

The 3M™ E-A-R™ UltraFit Plus™ Corded Earplugs features a premolded, triple-flange design that fits comfortably in most ear canals. Quick and easy insertion with paddle-style stems.

UPC #	Part #	Description	Noise Reduction Rating (NRR)*
10-008052-94004-7	340-6004	3M™ E-A-R™ UltraFit Plus™ Corded Earplugs 340-6004, in Poly Bag 400 EA/Case	26 dB. CSA Class AL



3M™ Tri-Flange™ Corded Earplugs

3M™ Tri-Flange™ Corded Earplugs features a proven, triple-flange design and pliable, premolded material to help provide clean and comfortable hearing protection. Fits flexibly in most ear canals.

UPC #	Part #	Description	Noise Reduction Rating (NRR)*
10-009304-59801-8	P3000	3M™ Tri-Flange™ Corded Earplugs P3000 400 EA/Case	26 dB. CSA Class AL



Earmuffs

3M™ PELTOR™ Optime™ H Series Over-the-Head Earmuffs

Soft, wide ear cushions and stainless steel band allow for even pressure and extra comfort.

UPC #	Part #	Description	Noise Reduction Rating (NRR)*
10-009304-50810-8	H10A	3M™ PELTOR™ Optime™ 105 Over-the-Head Earmuffs H10A 10 EA/Case	30 dB CSA Class AL
10-009304-50807-4	H7A	3M™ PELTOR™ Optime™ 101 Over-the-Head Earmuffs H7A 10 EA/Case	27 dB. CSA Class A



3M™ PELTOR™ X Series Earmuffs

Comfort with modern styling. Achieve a wide range of attenuation levels designed to meet the needs of the electrical utilities industry. Available with hard hat adapters. Also available for cap style hard hats.

UPC #	Part #	Description	Noise Reduction Rating (NRR)*
10-009304-59372-0	X1A	3M™ PELTOR™ Over-the-Head Earmuffs X1A/37270(AAD) 10 EA/Case	22 dB CSA Class A
10-009304-59372-7	X2A	3M™ PELTOR™ Over-the-Head Earmuffs X2A/37271(AAD) 10 EA/Case	24 dB CSA Class A
10-009304-59372-4	X3A	3M™ PELTOR™ Over-the-Head Earmuffs X3A/37272(AAD) 10 EA/Case	28 dB CSA Class AL
10-009304-59372-1	X4A	3M™ PELTOR™ Over-the-Head Earmuffs X4A/37273(AAD) 10 EA/Case	27 dB CSA Class AL
10-009304-59372-8	X5A	3M™ PELTOR™ Over-the-Head Earmuffs X5A/37274(AAD) 10 EA/Case	31 dB CSA Class AL



**3M strongly recommends fit testing of hearing protectors. Research suggests that many users will receive less noise reduction than indicated by the NRR due to variation in earmuff fit, earmuff fitting skill and motivation of the user. If the NRR is used to estimate typical workplace protection, 3M recommends that the NRR be reduced by 50% or in accordance with applicable regulations.*



Respiratory Protection

Fresh air. It's vital in the moment and for the long-term health and safety of electrical utilities workers. That's why 3M assists in helping you identify and assess the risks in your working environment, and designs respirators and powered and supplied air solutions to help provide breathing protection against hazards like dusts, fumes, gases and more.

Reusable Respirators

3M™ Rugged Comfort Quick Latch Half Facepieces Respirators, 6500 Series

This facepiece combines comfort, durability, and stability. The proprietary quick latch design offers an easy, one-hand touch drop-down mechanism for putting the facepiece on and/off outside of contaminated areas.

UPC #	Part #	Description
50-005113-14948-1	6501QL	3M™ Rugged Comfort Quick Latch Half Facepiece Reusable Respirator 6501QL/49488 Small 10 EA/Case
50-005113-14949-4	6502QL	3M™ Rugged Comfort Quick Latch Half Facepiece Reusable Respirator 6502QL/49490 Medium 10 EA/Case
50-005113-14949-8	6503QL	3M™ Rugged Comfort Quick Latch Half Facepiece Reusable Respirator 6503QL/49492 Large 10 EA/Case



3M™ Half Facepiece Respirator, 6000 Series

This half facepiece reusable respirator offers reliable and convenient respiratory protection and is suitable for many situations, helping provide protection against particulates and a wide variety of gases and vapors according to NIOSH approvals.

UPC #	Part #	Description
50-005113-10702-2	6200	3M™ Half Facepiece Reusable Respirator 6200/07025(AAD) Medium 24 EA/Case
50-005113-10702-9	6300	3M™ Half Facepiece Reusable Respirator 6300/07026(AAD) Large 24 EA/Case



3M™ Full Facepiece Respirators

The 3M Full Facepiece Respirator, 6000 Series, and the 3M Ultimate FX Full Facepiece Respiratory, FF-400 Series offer lightweight comfort and ease of use. Combine with appropriate 3M™ Particulate Filters and Cartridges to help provide respiratory protection against particulates and/or a variety of gases and vapors.

UPC #	Part #	Description
50-005113-85414-5	6800	3M™ Full Facepiece Reusable Respirator 6800 Medium 4 EA/Case
50-005113-85415-5	6900	3M™ Full Facepiece Reusable Respirator 6900 Large 4 EA/Case
50-005113-58942-2	FF-402	3M™ Ultimate FX Full Facepiece Reusable Respirator FF-402 Medium 4 EA/Case
50-005113-58942-3	FF-403	3M™ Ultimate FX Full Facepiece Reusable Respirator FF-403, Large 4 EA/Case



6800 Shown

3M™ Organic Vapor Cartridge 6001

NIOSH approved against certain organic vapors. Use with 3M™ Half and Full Facepieces 6000, 7000 and FF-400 Series.

UPC #	Part #	Description
50-005113-82167-5	6001	3M™ Organic Vapor Cartridge 6001 60 EA/Case



3M™ Organic Vapor Cartridge/Filter 60921, P100

NIOSH approved against certain organic vapors and particulates. Use with 3M™ Half and Full Facepieces 6000, 7000 and FF-400 Series.

UPC #	Part #	Description
50-005113-84646-8	60921	3M™ Organic Vapor Cartridge/Filter 60921, P100 60 EA/Case



3M™ Organic Vapor/Acid Gas Cartridge/Filter 60923, P100

NIOSH approved against certain organic vapors, acid gases and particulates. Use with 3M™ Half and Full Facepieces 6000, 7000 and FF-400 Series.

UPC #	Part #	Description
50-005113-84646-2	60923	3M™ Organic Vapor/Acid Gas Cartridge/Filter 60923, P100 60 EA/Case



3M™ Multi Gas/Vapor Cartridge/Filter 60926, P100

NIOSH approved against certain organic vapors, acid gases, ammonia/methylamine, formaldehyde and particulates. Use with 3M™ Half and Full Facepieces 6000, 7000 and FF-400 Series.*

UPC #	Part #	Description
50-005113-85418-8	60926	3M™ Multi Gas/Vapor Cartridge/Filter 60926, P100 60 EA/Case



*OSHA requires that gas-proof goggles be worn with half facepiece respirators when used against formaldehyde.

3M™ Filter Adapter 502, Respiratory Protection System Component

Use to attach 3M™ Particulate Filters 2000 Series and 7093 to the 3M™ Respirators 5000 Series and 3M™ Cartridges 6000 Series for a wide variety of applications.

UPC #	Part #	Description
50-005113-82151-3	502	3M™ Filter Adapter 502, Respiratory Protection System Component 100 EA/Case



3M™ Particulate Filter 2091/07000(AAD), P100

NIOSH approved for environments containing certain oil and non-oil based particles.

UPC #	Part #	Description
50-005113-10700-9	2091	3M™ Particulate Filter 2091/07000(AAD), P100 100 EA/Case



3M™ Particulate Filter 2096, P100, with Nuisance Level Acid Gas Relief*

NIOSH approved for environments containing certain oil and non-oil based particles. 3M recommended for relief against nuisance levels of acid gases.

UPC #	Part #	Description
50-005113-85429-0	2096	3M™ Particulate Filter 2096, P100, with Nuisance Level Acid Gas Relief 100 EA/Case



3M™ Particulate Filter 2097, P100, with Nuisance Level Organic Vapor Relief*

NIOSH approved for environments containing certain oil and non-oil based particles. 3M recommended for nuisance level organic vapor relief and for ozone protection up to 10X OSHA PEL.**

UPC #	Part #	Description
50-005113-10718-6	2097	3M™ Particulate Filter 2097/07184(AAD), P100, with Nuisance Level Organic Vapor Relief 100 EA/Case



*Nuisance level refers to concentrations not exceeding the OSHA PEL or applicable government occupational exposure limits, whichever is lower.

**Not NIOSH certified for use against ozone.

Disposable Respirators

3M™ Particulate Respirator 8210, N95

Breathe easier! Advanced Electrostatic Media technology enhances particulate capture while reducing breathing resistance. Designed with welded strap attachment for greater durability, soft nose foam, for more comfort and adjustable noseclip to help promote a secure custom seal.

UPC #	Part #	Description
50-005113-84645-3	8210	3M™ Particulate Respirator 8210, N95 160 EA/Case



3M™ Particulate Respirator 8511, N95

Stays cooler!* Our most popular valved model is suited for hot, humid environments, or for long periods of wear.

UPC #	Part #	Description
50-005113-85434-8	8511	3M™ Particulate Respirator 8511, N95 80 EA/Case

*Compared to non-valve disposable respirators.



3M™ Particulate Welding Respirator 8212, N95, with Face seal

Long-lasting comfort in tough environments. Features include welding web, cake-resistant filter media, nose foam, adjustable noseclip, and buckle straps. Plus a comfortable foam face seal.

UPC #	Part #	Description
50-005113-85414-0	8212	3M™ Particulate Welding Respirator 8212, N95, with Faceseal 80 EA/Case



3M™ Particulate Respirator 8233, N100

For those who want NIOSH's highest-rated filtration efficiency in a disposable respirator, this provides a minimum filter efficiency of 99.97% against non-oil based particles.

UPC #	Part #	Description
50-005113-85414-4	8233	3M™ Particulate Respirator 8233, N100 20 EA/Case



3M™ Particulate Respirator 8271, P95

Helps protect against certain oil and non-oil based particles. It features a collapse-resistant shell for increased durability in most hot, humid conditions.

UPC #	Part #	Description
50-005113-85428-1	8271	3M™ Particulate Respirator 8271, P95 80 EA/Case



3M™ Aura™ Particulate Respirator 9211+/37193(AAD), N95

Comfort meets convenience. Three-panel respirator that's suited for work situations involving heat, humidity, or long periods of wear.

UPC #	Part #	Description
50-005113-13719-9	9211+	3M™ Aura™ Particulate Respirator 9211+/37193(AAD) N95 120 EA/Case



3M™ Particulate Respirator 8576, P95, with Nuisance Level Acid Gas Relief

Helps provide comfortable, reliable worker protection against certain oil and non-oil based particles – including those with nuisance levels of acid gases** such as sulphur dioxide, hydrogen fluoride, and/or chlorine.

UPC #	Part #	Description
50-005113-85437-4	8576	3M™ Particulate Respirator 8576, P95, with Nuisance Level Acid Gas Relief 80 EA/Case



**Nuisance level refers to concentrations not exceeding the OSHA PEL or applicable government occupational exposure limits, whichever is lower.

3M™ Versaflo™ Powered and Supplied Air

3M™ Versaflo™ Light and Heavy Industry Kits bring long-lasting comfort and protection to your shifts. Ready to go right out of the box, these kits are a convenient solution to take on a variety of electrical utility tasks.

3M™ Versaflo™ TR-300-LIK Light Industry PAPR Kit

UPC# 00051141567419

Includes:

- M-206 Respiratory Faceshield Assembly with M-985 Earmuff
- BT-30 Length Adjusting Breathing Tube
- TR-302N PAPR Unit
- TR-326 High Durability Belt
- TR-332 High Capacity Battery
- TR-362 Spark Arrestor
- TR-341N Battery Charger
- TR-3712N HE Filter
- TR-3600 Prefilter
- TR-970 Airflow Indicator

See clearer

Durable faceshield helps protect against flying objects and sparks while retaining optical clarity.

Stay productive

With our PPE equipment designed for compatibility, workers can easily accommodate eyeglasses and attach earmuffs.

Beat harsh environments

Rugged work demands durable and strong head protection.



Breathe easier

When working in hot, humid conditions, stay comfortable with powered air.

Work longer

An extended battery life option lets workers work in a remote location for longer periods of time.

3M™ Versaflo™ TR-613N PAPR Assembly

UPC# 00051131373396

Includes:

- TR-602N Motor/Blower
- BT-30 Length Adjusting Breathing Tube
- TR-630 Standard Battery
- TR-626 High Durability Belt
- Battery Charger, Filters and Cartridges sold separately.



3M™ Versaflo™ TR-600-HIK Heavy Industry PAPR Kit

UPC# 00051131373747

Includes:

- M-307 Respiratory Hard Hat Assembly with Premium Visor and Face Seal
- TR-602N PAPR Unit
- TR-632 High Capacity Battery
- BT-30 Length Adjusting Breathing Tube
- TR-626 High Durability Belt
- TR-6530N OV/AG/HE Cartridge
- TR-6500 Filter Cover
- TR-641N Single Station Battery Charger Kit
- TR-971 Airflow Indicator
- BT-926 High Temperature Breathing Tube Cover
- TR-6600 Prefilter (x2)
- TR-662 Spark Arrestor (x2)





Fall Protection

Fall Protection

A leader in safety. A leader in fall protection. We've joined forces to create a safer future. The products, people and service of the trusted DBI-SALA® fall protection brand are now part of 3M. That means 3M now carries comprehensive portfolio of quality products for the electrical utilities industry. Together, we can help you elevate your employees' safety and comfort to new heights.



3M™ DBI-SALA® Cynch-Lok™ Fall-Restricting Devices

Move faster, easier and safer on wood poles. Make one-handed adjustments without pinching. Our ergonomic Cynch-Lok™ Fall-Restricting Devices make it all possible. Available with rope and web options, these reliable devices feature one-piece construction and are even reconfigurable for left-handed use with a replacement carabiner to maximize versatility and flexibility in the field. Cynch-Lok™ meets CSA Z259.14 standards for Type A and AB (dry, wet and icy poles) and ASTM F887.

1204057 Cynch-Lok™ Rope for Distribution Poles

Pole Size (Dia/Circ):
Min 5-1/2 in./17-1/2 in.
Max 18-1/2 in./58 in.,
Weight: 4.8 lbs. (2.1 kg)

1204058 Cynch-Lok™ Rope for Transmission Poles

Pole Size: (Dia/Circ):
Min 5-1/2 in./17-1/2 in.
Max 30-1/2 in./96 in.,
Weight: 5.3 lbs. (2.4 kg)



1204075 Cynch-Lok™ Web for Distribution Poles

Pole Size (Dia/Circ):
Min 5-1/2 in./17-1/2 in.
Max 18-1/2 in./58 in., Weight: 4.9 lbs. (2.2 kg)

1204076 Cynch-Lok™ Web for Transmission Poles

Pole Size: (Dia/Circ):
Min 5-1/2 in./17-1/2 in.
Max 30-1/2 in./96 in., Weight: 5.4 lbs. (2.4 kg)



Cynch-Lok™ Replacement Components

1200115 Cynch-Lok™ Replacement Rope Interior Strap

Weight: 2.9 lbs. (1.3 kg)



1200136 Cynch-Lok™ Replacement Web Interior Strap

Weight: 3 lbs. (1.3 kg)



1200110 Cynch-Lok™ Replacement Strap for Distribution Poles

Pole Size (Dia/Circ): Min 5-1/2 in./17-1/2 in. Max 18-1/2 in./58 in., Weight: 1.9 lbs. (.86 kg)



1200111 Cynch-Lok™ Replacement Strap for Transmission Poles

Pole Size: (Dia/Circ): 5-1/2 in./17-1/2 in. Max 30-1/2 in./96 in., Weight: 2.4 lbs. (1.1 kg)



1204077 Cynch-Lok™ Left Carabiner Conversion Kit - Web

11/16 in. gate (17.5 mm), captive eye.



1204074 Cynch-Lok™ Left Carabiner Conversion Kit - Rope

11/16 in. gate (17.5 mm)



9509844 Handline Keeper for Lineman Belt

Polypropylene, with slot to attach to lineman belt.



3M™ DBI-SALA® Positioning Lanyards

1234070 Adjustable Rope Positioning Lanyard

With rope adjuster and steel snap hook on one end and carabiner on the other x 8 ft. (2.4 m)



1234080 Adjustable Rope Positioning Lanyard

With rope adjuster and aluminum carabiners on ends x 8 ft. (2.4 m)
1234082 6 ft. (1.8 m) length



1234083 Adjustable Rope Positioning Lanyard for Electrical/Hot Work Use

With Technora® kernmantle rope, rope adjuster and aluminum carabiners on ends x 8 ft. (2.4 m)



1234030 Adjustable Web Positioning Lanyard

With 6 ft. (1.8 m) rope adjuster.



1234071 Adjustable Rope Positioning Lanyard

With rope adjuster and aluminum snap hook on one end and carabiner on the other x 8 ft. (2.4 m)



3M™ DBI-SALA® Belts and Harnesses

When you're 75 feet off the ground, your belt or harness is more than just your safety connection—it's everything. Your comfort, confidence, productivity and versatility on the job are all directly connected to the quality of its design and craftsmanship.



Belts

1001398 Seat-Belt™ 4D Lineman Belt

Maximize your comfort, freedom of movement and safety with the ergonomic Seat-Belt™ 4D Belt. Meets ASTM and OSHA regulations. (Size D24)



Size	Part Number
D18	1001392
D19	1001393
D20	1001394
D21	1001395
D22	1001396
D23	1001397
D24	1001398
D25	1001399
D26	1001400
D27	1001401
D28	1001402
D29	1001403
D30	1001404

1 Durability and comfort

Rolled edge adds durability and comfort at the hips.

2 Hassle-free

S-shaped large full floating D-rings, for hassle-free connection.

3 Cynch-Lok™ compatible

Small D-rings designed for Cynch-Lok™ Fall Restricting Device.

4 Improved comfort

The design distributes weight throughout the contoured, reinforced seat for improved work comfort.

5 Easy adjustments

Grommet tongue-buckle belt provides easy adjustments and improved durability.

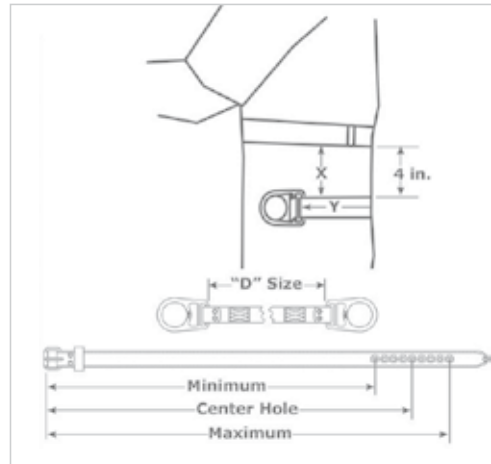

Where to measure to determine the correct "D" size for a Lineman's Belt:

X = Distance from waist or top of hip bone to where Lineman's Belt is worn.

Y = Measurement is from front of hip bone around the back to the front of the other hip bone. This measurement is the "D" size.



"D" Size		Belt Sizing					
		Minimum		Center Hole		Maximum	
in.	cm	in.	cm	in.	cm	in.	cm
D18	46	32	81	36	91	40	102
D19	48	33	84	37	94	41	104
D20	51	34	86	38	97	42	107
D21	53	36	91	40	102	44	112
D22	56	37	94	41	104	45	114
D23	58	38	97	42	107	46	117
D24	61	40	102	44	112	48	122
D25	64	41	104	45	114	49	124
D26	66	42	107	46	117	50	127
D27	69	44	112	48	122	52	132
D28	71	45	114	49	124	53	135
D29	74	46	117	50	127	54	137
D30	76	47	119	51	130	55	140

1001385 2D Lineman Belt

Make adjustments easier without durability concerns. This belt features a grommet tongue buckle and is made with 100% top grain leather.



1001385

Size	Part Number
D18	1001379
D19	1001380
D20	1001381
D21	1001382
D22	1001383
D23	1001384
D25	1001386
D26	1001387
D27	1001388
D28	1001389
D29	1001390
D30	1001391

1001453

Size	Part Number
D21	1001450
D22	1001451
D23	1001452
D24	1001453
D25	1001454
D26	1001456
D27	1001457
D28	1001455

1001453 Seat-Belt™ 4D Double Tongue-Buckle Lineman Belt



3M™ DBI-SALA® Lineman Pole Climbing Kits



1050017 Lineman Pole Climbing Kit

- 1001398 Seat-Belt™ 4D Lineman Belt
- 1204075 Cynch-Lok™ Fall Restricting Device – Web
- 234071 8 ft. (2.4 m) Adjustable Rope Positioning Lanyard
- 9511049 Backpack



1050028 Lineman Pole Climbing Kit

- 1001398 Seat-Belt™ 4D Lineman Belt
- 1204057 Cynch-Lok™ Fall Restricting Device – Rope
- 1234071 8 ft. (2.4 m) Adjustable Rope Positioning Lanyard
- 9511049 Backpack

3M™ DBI-SALA® Full-Body Arc Flash Harnesses

1113318 ExoFit NEX™ Arc Flash Harness

With Nomex®/Kevlar® fiber web, PVC-coated aluminum back and side D-rings, locking quick-connect buckles, sewn-in hip pad and belt, comfort padding. (XLarge)

1113315 Small

1113316 Medium

1113317 Large



1113369 ExoFit NEX™ Arc Flash Tower Climbing Harness

With Nomex®/Kevlar® fiber web, back web loop, PVC-coated aluminum front and side D-rings, locking quick-connect buckles, and with Nomex®/Kevlar® fiber back and leg pads, leather insulators, seat sling. (XLarge)

1113357 Small

1113358 Medium

1113368 Large



1103088 ExoFit NEX™ Arc Flash Harness

With Nomex®/Kevlar® fiber web, PVC-coated aluminum back D-ring, locking quick-connect buckles, comfort padding. (XLarge)

1103085 Small

1103086 Medium

1103087 Large



1113760 ExoFit NEX™ Rope Access/Rescue Harness - Arc Flash

PVC-coated aluminum front, suspension, back, and side D-rings, locking quick-connect buckles, Nylon/Kevlar® fiber web, Kevlar® fiber hybrid padding, leather insulators. (Size XLarge)

1113757 Small

1113758 Medium

1113759 Large



1113764
**ExoFit NEX™ Rope Access/
 Rescue Harness - Arc Flash**

No-step through configuration, PVC-coated aluminum front, suspension, back, and side D-rings, locking quick-connect buckles, Nylon/Kevlar® fiber web, Kevlar® fiber hybrid padding, leather insulators. (XLarge)

1113761 Small

1113762 Medium

1113763 Large



1110882
ExoFit™ XP Arc Flash Harness

Construction style, Nomex®/Kevlar® fiber, web and pads, back web loop, quick-connect buckles and Kevlar® fiber pass-through body belt. (XLarge)

1110883 Small

1110880 Medium

1110881 Large



1110892
ExoFit™ XP Arc Flash Harness

With Nomex®/Kevlar® fiber, PVC-coated hardware, pass-through buckles, back and leg Nomex®/Kevlar® fiber pads. (Size XLarge)

1110893 Small

1110890 Medium

1110891 Large



1110752
Delta™ Arc Flash Harness

7,000 lb. nylon web, no metal above the waist, front and back web loop, pass-through buckle legs, leather insulators. (XLarge)

1110754 Small

1110750 Medium

1110751 Large

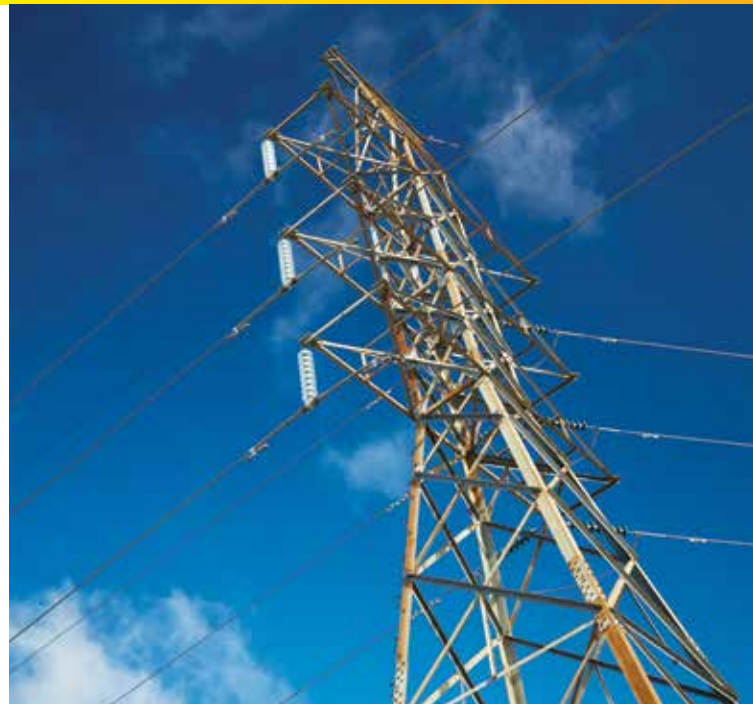

1100784
Delta™ Arc Flash Harness

7,000 lb. nylon web, quick-connect chest buckle, tongue-buckle leg straps, leather insulators, rescue loops. (XLarge)

1110773 Small

1110774 Medium

1110783 Large



1150058
Delta™ Arc Flash Kit

Includes 1110752 Delta™ Arc Flash Nylon Harness with web loop and Arc Flash Shock-Absorbing Lanyard, 6 ft. (1246305), with bag. (XLarge)

1150054 Kit with Large Harness (1110752)



9505712
**Flame-Resistant
 Suspension Trauma
 Safety Straps**

One pair, connects to most harnesses.





3M™ DBI-SALA®
Shock-Absorbing Lanyards

Climb steel structures with confidence. From the strongest rebar hooks to the smallest shock pack, all of our EZ-Stop™ and Shockwave™2 Arc Flash Lanyards are built to maximize performance, reliability and ease of use out in the field. All models shown are ASTM F887 certified for arc flash use.

Shock-Absorbing Lanyards

1246306
EZ-Stop™ Arc Flash Web Lanyard

Single-leg with Nomex®/Kevlar® fiber web and shock pack, snap hooks at each end x 6 ft. (1.8 m)



1246317
EZ-Stop™ Force2™ Arc Flash Adjustable Lanyard

Adjustable web single-leg Force2™ with Nomex®/Kevlar® fiber web and shock pack, snap hooks at each end x 6 ft. (1.8 m)



1244610
Shockwave™2 Arc Flash Web Lanyard

Single-leg with elastic Nomex®/Kevlar® fiber web and snap hooks at each end x 6 ft. (1.8 m)



1244611
ShockWave™2 Arc Flash Lanyard

With Nomex®/Kevlar® fiber single-leg with snap hook and web loop x 6 ft. (1.8 m)



1244632
ShockWave™2 Arc Flash Twin-Leg Lanyard

With Nomex®/Kevlar® fiber, aluminum hooks at leg ends x 6 ft. (1.8 m)



1244639
ShockWave™2 Arc Flash Twin-Leg Lanyard

With Nomex®/Kevlar® fiber, aluminum snap hook and Safflok Tower Hooks on leg ends x 6 ft. (1.8 m)



3M™ DBI-SALA® Modular Lanyards

1246305 EZ-Stop™ Arc Flash Web Lanyard

Single-leg with Nomex®/Kevlar® fiber web and shock pack choker, snap hook at leg end x 6 ft. (1.8 m)



1244633 Shockwave™ 2 Arc Flash Web Lanyard

With Nomex®/Kevlar® fiber, elastic legs, snap hook at one end, steel rebar hooks with 2.5 in. (64 mm) gate openings at leg ends x 6 ft. (1.8 m)



1246323 EZ-Stop™ Arc Flash Twin-Leg Lanyard

With Nomex®/Kevlar® fiber web and shock pack, aluminum snap hook at one end, aluminum rebar hooks with 2.5 in. (64 mm) gate openings at leg ends x 6 ft. (1.8 m)



244614 Shockwave™ 2 Arc Flash Web Lanyard

Single-leg with Nomex®/Kevlar® fiber web, choker on one end and aluminum rebar hook at leg end x 6 ft. (1.8 m)



1246309 EZ-Stop™ Arc Flash Web Lanyard

Single-leg with Nomex®/Kevlar® fiber web and shock pack, tie back floating D-ring, snap hooks at each end x 6 ft. (1.8 m)



1246304 EZ-Stop™ Arc Flash Web Lanyard

Single-leg with Nomex®/Kevlar® fiber web and shock pack, snap hooks at each end x 4 ft. (1.2 m)



3M™ DBI-SALA®

Self-Retracting Lifelines

Safe. Compact. Versatile. Your Self-Retracting Lifeline (SRL) has to be all three to overcome the unique challenges of the electrical utility industry. From the tight space of bucket trucks and aerial lifts, to anchor systems in substations, the only thing more important than your mobility is your safety in areas where risk of an arc flash event exists. That's why our SRLs are built to stop falls within inches, reduce falling distances and meet OSHA, ANSI and CSA requirements.

- Wide variety of configurations to meet virtually any arc flash or hot-work need
- Two unique web leg configurations specifically designed for bucket truck and aerial lift applications
- 420 lb. (190 kg) user capacity
- Electric arc performance of 40 cal/cm² meets ANSI and CSA regulations after exposure to a 40 cal/cm² arc blast



Model shown
3101526

- 1 Quick-connect anchorage connector
 - 2 Swiveling anchorage loop
 - 3 Impact-resistant housing
 - 4 Automatic quick-activating fall arrestor centrifugal brake stops a worker quickly and reduces fall distances
 - 5 Arc flash logo to easily identify the product as arc flash compliant (40 cal/cm²)
 - 6 Nomex®/Kevlar® fiber web lifeline with reinforced edges
 - 7 3,600 lb. (16 kN) gate hook
- 420 lb. (190 kg) weight capacity
 - 8 ft. (2.4 m) length
 - Ideal for bucket truck and aerial lift use
 - Impact indicator
 - Equipped with RFID



3M™ DBI-SALA® Nano-Lok™ Self-Retracting Lifelines

3101574 Nano-Lok™ Arc Flash Self-Retracting Lifeline

3/4 in. (19 mm) Nomex®/Kevlar® fiber webbing and web loop, swiveling anchor loop with 13 in. (33 mm) web extension with aluminum snap hook x 8 ft. (2.4 m)



3101536 Nano-Lok™ Arc Flash Twin-Leg Self-Retracting Lifeline

3/4 in. (19 mm) Nomex®/Kevlar® web and steel rebar hooks, quick connector for harness mounting x 8 ft. (2.4 m)



3101575 Nano-Lok™ Arc Flash Self-Retracting Lifeline

3/4 in. (19 mm) Nomex®/Kevlar® fiber webbing and aluminum carabiner, swiveling anchor loop with 13 in. (33 mm) web extension with aluminum snap hook x 8 ft. (2.4 m). *Best seller for bucket truck applications.*



3101526 Nano-Lok™ Arc Flash Self-Retracting Lifeline

3/4 in. (19 mm) Nomex®/Kevlar® fiber webbing and steel snap hook, quick connector for harness mounting x 8 ft. (2.4 m)



	Lifeline hook											Anchorage type				U.S. Part Number
	Steel Snap Hook	Steel Swiveling Snap Hook	Steel Rebar Hook	Steel Rebar Look Hook	Aluminum Carabiner	Aluminum Rebar Hook	Aluminum Snap Lock Hook	Dielectric Web Loop	11' Tie-Back	Single-Leg Interface	Twin-Leg Interface	Steel Carabiner	Web Leg w/ Snap Hook			
8 ft. Single Leg	■									■				3101526		
		■								■				3101527		
			■							■				3101528		
				■						■				3101529		
					■					■				3101530		
						■				■				3101531		
							■			■				3101532		
		■										■		3101533		
									■	■				3101562		
									■					3101563		
8 ft. Twin Leg	■										■			3101534		
		■									■			3101535		
			■								■			3101536		
				■							■			3101537		
					■						■			3101538		
						■					■			3101539		
							■				■			3101540		
Bucket Truck									■				■	3101574		
					■								■	3101575		

3M™ DBI-SALA® Ultra-Lok™ Self-Retracting Lifelines

3103175 Ultra-Lok™ Self-Retracting Lifeline

1 in. (2.5 cm) Nomex®/Kevlar® fiber webbing with swivel snap hook x 11 ft. (3.3 m)



3103275 Ultra-Lok™ Self-Retracting Lifeline

1 in. (2.5 cm) Nomex®/Kevlar® fiber webbing with swivel snap hook x 20 ft. (6.1 m)



2000112 Carabiner

11/16 in. (1.75 cm) gate





3M™ DBI-SALA® Fall Protection for Tools

Protecting workers takes more than just keeping them from falling. Their equipment also needs to be kept safe at height. That's why we've pioneered an innovative line of products and solutions to help prevent dropped tools and equipment. From construction sites to oil rigs, we help make work environments safer and more productive by protecting workers from hazards that can result in personal injury, equipment damage and tool loss.

Buckets

1500134 Safe Bucket - Canvas

Help prevent dropped objects while carrying heavy loads. Our puncture-resistant Safe Buckets feature an integrated hook and loop or drawstring closure system and an aluminum carabiner and hoisting strap for easy transport.

- 100 lb. (45.4 kg) load rating
- 15 in. (38 cm) height; 12.5 in. (31.75 cm) diameter; 1840 in.³ capacity

1500133 100 lb. Drawstring Safe Bucket – Canvas

1500139 250 lb. Drawstring Safe Bucket – Vinyl

1500140 250 lb. Hook and Loop Safe Bucket – Vinyl



1500135 5 Gallon Safe Bucket

- Used to transport standard 5 gallon buckets.
- 5 gallon plastic buckets clip into the Safe Bucket with a unique hook system.
- When not being used, the Safe Bucket can be flattened for easy storage.
- Unique patent pending locking hook and loop closure system helps ensure that there are no accidental spills during lifting and transportation.
- 100 lb. (45.5 kg) load rating.



1500136 4 ft. Long Safe Bucket

Transport scaffolding and longer tools safely and easily with our Long Safe Buckets.

- More effective than hand-to-hand transportation or using rope with hitch knots.
- Hook and loop top closure system keeps poles secure during lift.
- Equipped with a double twist-action locking carabiner for maximum safety.
- 100 lb. (45.4 kg) load rating

1500137 6 ft. Long Safe Bucket

1500138 10 ft. Long Safe Bucket



3M™ DBI-SALA® Pouches

1500132 Utility Pouch

- Features two outside pockets for storing spud wrenches and two inner pockets for storing additional tools.
- Tools can be tethered to D-rings on the inside and outside of the pouch.
- Adjustable side-release closure system helps prevent objects from falling out when not in use.



1500130 Utility Pouch with Zipper Closure

1500119 Small Parts Pouch – Canvas Black

- Innovative self-closure system traps objects inside.
- Easy to retrieve objects since no opening or closing is necessary.
- Compatible with most tool belts.



1500122 Small Parts Pouch - Vinyl Yellow

Tethers

1500059 Clip2Clip Coil Tether

Tool lanyard, coil tether, 2 lb. (0.9 kg) capacity, non-conductive.



1500047 Hook2Loop Bungee Tether

Tool lanyard, bungee tether, 15 lb. (6.8 kg) capacity, self-locking carabiner.



1500061 Hard Hat Tether

Hard hat lanyard, coil tether, 2 lb. (0.9 kg) capacity. (10 pack)



1500089 Adjustable Radio/Cell Phone Holster

Wear virtually any hand-held radio, cell phone or similar device from your belt or harness. Includes Clip2Loop Coil Tether (1500065) and Micro D-Ring (1500010).



Tapes

1500044 Quick-Wrap Tape – Yellow

108 in. of 1 in.-wide tape that creates instant connection points when used with D-Rings and Tool Cinches.

1500035 Quick-Wrap Tape – Blue



Tool Cinch Attachments

1500015 Tool Cinch

- Tool Cinch Attachments feature a cinch design that allows users to quickly secure equipment up to 35 lbs.
- Stabilization wings can be used to keep Tool Cinch Attachments in place using our Quick-Wrap Tape.

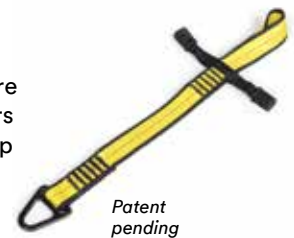

Patent pending

3M™ DBI-SALA® D-Rings

1500005 D-Ring Attachment – Non-Conductive

0.5 in. D-ring attachment point, 2 lb. (0.9 kg) capacity, non-conductive x 2.5 in. (10 pack)



1500007 D-Ring Attachment

1 in. D-ring attachment point, 5 lb. (2.3 kg) capacity x 3.5 in. (10 pack)



1500009 D-Ring Cord

- Easily cinches to tools weighing up to 5 lbs. (2.3 kg).
- Simply pass the loop end of a D-Ring Cord through a pre-drilled hole or closed handle to create an attachment point.
- Extremely durable and reusable.
- (10 pack)

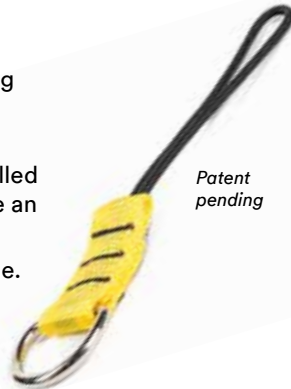

1500010 Micro D-Ring

- Designed to allow for easy tethering of small devices such as cell phones, cameras and radios.
- Adheres to most surfaces creating an attachment point in seconds.
- Load rated for 2 lbs. when used with 1500060 Clip2Loop Coil Tether.
- Uses 3M very high bond adhesive.
- (10 pack)



3M™ DBI-SALA® Quick Spins

Simply slide a Quick Spin onto the handle of a tool and it's ready to tether in seconds. Featuring swivel spin tops that make the tool resistant to tangling, Quick Spins are also reusable and suitable for non-conductive use. (10 packs)



Part Number	Description	Load rating
1500027	Small 0.6 in. (1.5 cm)	1 lbs. (0.5 kg)
1500028	Medium 0.8 in. (2 cm)	1 lbs. (0.5 kg)
1500029	Large 1 in. (2.5 cm)	1 lbs. (0.5 kg)
1500030	X-Large 1.2 in. (3.1 cm)	1 lbs. (0.5 kg)
1500031	Pen Holder 0.3 in. (0.8 cm)	-
1500032	Pen Holder with Coil 0.3 in. (0.8 cm)	-
1500033	Permanent Marker 0.5 in. (1.3 cm)	-
1500034	Permanent Marker with Coil 0.5 in. (1.3 cm)	-

1500028



1500030

3M™ DBI-SALA® Systems

Work confidently, even in complex situations. From power plants to construction sites, indoors or outdoors, our extensive portfolio of Fall Arrest Systems gives you the flexibility workers need to get even the toughest jobs done safer and easier.

8516691 Portable Fall Arrest Post

- Three independent swiveling tie-off points.
- 360 degrees of protection for three workers.
- Telescopic design; 32.75 in.-46 in.-57.25 in. (83.2 cm-116.8 cm-145.4 cm)
- Lightweight and durable aluminum construction.
- Leveling screws plumb system on inclines up to 15 degrees.
- Built-in anchor ring for horizontal lifeline attachment.
- Portable and fixed bases provide complete jobsite versatility.



8516693 Rescue Davit Arm for Portable Fall Arrest Post

Simplify rescue and material handling with the optional Rescue Davit Arm. Its lightweight aluminum construction makes it easy to transport, set up and attach to the Portable Fall Arrest Post (8516691—order separately).



8516996 14 ft. Uni-Anchor Fall Arrest Post

Mounts using uni-anchor plates and extends up to 14 ft. (4.2 m) to provide a one-man-rated fall arrest anchor point.



Accessories

8516692 **14 in. (356 mm) Anchor Post Extension**

Provides option to tie-off one worker at an increased height of 68.5 in. (174 cm) Weight: 5 lbs. (2.2 kg)



8517565 **Carrying Bag**

Heavy-duty carrying bag for Portable Fall Arrest Post.



8517422 **Sand-Blasted Steel Uni-Anchor**

With tie-off anchor.



8516997 **Uni-Anchor I-Beam**

Base portable anchor clamps to I-beams, 56 lbs. (25.5 kg)

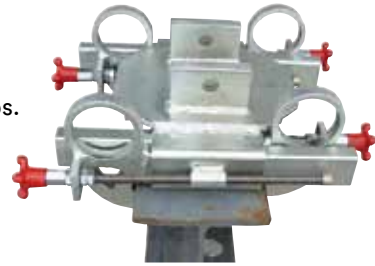

3M™ DBI-SALA® EZ-Line™ Retractable Horizontal Lifeline (HLL) System

7605060 **EZ-Line™ Retractable HLL System**

Speed up your productivity on the job. EZ-Line™ is an easy to use lifeline system that you can install, remove and store extremely fast. Its innovative retractable design eliminates large and bulky coils of cable that are difficult to set up, relocate and store.

- Built-in winch for fast and easy setup, use and dismantling.
- Customize length in any increment up to 60 ft. (18.25 m)
- Built-in pre-tension and impact indicators simplify setup and inspection.
- Up to 33% lighter than conventional systems.
- Two worker capacity.



3M™ DBI-SALA® Saflok™ Steel Structure Fall Arrest System

2104810 Saflok™ Steel Structure Fall Arrest System

Loads of applications. 100% fall protection. The unique Saflok™ Steel Structure Fall Arrest System is great for beams, angle iron, bar joists, lattice steel and other structures in traditional power plants, substations, switch yards, manufacturing facilities or construction sites.

9502776
Carry Bag



2100420
High Dielectric Rope



2100425
Anchor Tube

2100418
Rescue
Loop
Sling



2000112
Carabiner

2100419
Installation/
Removal Tool

5002055
Rope
Grab with
Integrated
Shock-
Absorbing
Lanyard

3M™ DBI-SALA® Lad-Saf™ Steel Pole Ladder Safety System

6100035 Bottom Bracket

Galvanized bolt-on bottom bracket with built-in tensioner.



6100136 Cable Guide

Flexible stainless steel cable guide support.



Angle iron, clamp-on, and steel pole weld-on systems also available. Call us today.



3M™ DBI-SALA® Tower Climbing Solutions

1002200 Tie-Off Adapter for Hot Work Use

Reinforced with Kevlar® fiber webbing; excellent for high heat environments, pass-through type with 1-3/4 in. polyester strength member x 6 ft. (1.8 m).



5900550 Cable Tie-Off Adapter

Pass-through design. 7 in. x 19-3/8 in. (9.5 mm) stainless steel cable with O-rings x 4 ft. (1.2 m).



5000400 Lad-Saf™ Mobile Rope Grab Kit

Complete rope grab system in a bag for safety and convenience on the job. Kit includes:

- Mobile Rope Grab (5000335)
- Shock-Absorbing Lanyard (1246012)
- Lifeline x 50 ft. (1202794)
- Counterweight (5901583)
- Tie-Off Adapter (1003000)
- Carrying Bag (9511597)



3M™ DBI-SALA® Confined Space Systems

8530352 4-in-1 Davit Guard System

Portable fall arrest, confined space entry and rescue system with davit and guardrail. System includes a collapsible base to reduce storage and transport space. A standard tie-off point provides a convenient 5000 lb. (22kn) anchorage point for fall arrest devices where required. Includes winch-mounting bracket



3400840 Sealed-Blok Self-Retracting Lifeline – Retrieval

Technora® aramid rope with retrieval function, swivel snap hook, mounting bracket and equipment bag x 30 ft. (9 m)

3400843 Sealed-Blok SRL 55 ft. (16.76 m)



8102001 Salalift™ II Manual Winch

Simple manual operation to raise or lower personnel or materials, requiring no power source. Gear ratio is 6:1 with an average lifting speed of 3.8 m/min. A quick-mount bracket mates with a bracket on all 3M™ DBI-SALA® support structures, allowing the user to easily retrofit with no additional hardware.



Model #	Salalift II Winch	Total weight
8102001	With 60 ft. (18.3 m) of 1/4 in. (6.4 mm) galvanized cable, mounting bracket and winch bag	16.3 kg
8102003	With 60 ft. (18.3 m) of 1/4 in. (6.4 mm) stainless steel cable, mounting bracket and winch bag	16.3 kg
8102009	With 90 ft. (27.4 m) of 3/16 in. (4.8 mm) galvanized cable, mounting bracket and winch bag	15.8 Kg
8102011	With 90 ft. (27.4 m) of 3/16 in. (4.8 mm) stainless steel cable, mounting bracket and winch bag	15.8 Kg
8102005	With 120 ft. (36.6 m) of 3/16 in. (4.8 mm) galvanized cable, mounting bracket and winch bag	16.7 Kg
8102007	With 120 ft. (36.6 m) of 3/16 in. (4.8 mm) stainless steel cable, mounting bracket and winch bag	16.7 Kg
8102050	With 50 ft. (15.2 m) of synthetic Technora® rope and lifeline counterweight, mounting bracket and winch bag	14.9 Kg

8000000 Aluminum Tripod – 7 ft. (2.13 m)

Features adjustable locking legs, safety chains, rubber safety shoes with spiked edges, top pulley assembly and a Mounting Bracket Base (8005048).



3M™ DBI-SALA®

Rescue Solutions

Controlled descent. Technical rope access. Regardless of the situation, you need rescue solutions that are light, quick to set up and easy to use, period. At 3M, we've got you covered with rescue harnesses, descent devices and more, all developed to stand up to the challenges and hazards of the electrical utilities industry.



3M™ DBI-SALA® Rescue Harnesses

1113323 ExoFit NEX™ Arc Flash Construction-Style Positioning/ Rescue Harness

Back and front web rescue loops, belt with pad and PVC-coated aluminum side D-rings, Nomex®/Kevlar® fiber webbing and comfort padding, locking quick-connect buckle leg straps. (XLarge)

1113320 Small

1113321 Medium

1113322 Large



1113328 ExoFit NEX™ Arc Flash Rescue Harness

Back and front web rescue loops, Nomex®/Kevlar® fiber webbing and comfort padding, locking quick-connect buckle leg straps. (XLarge)

1113325 Small

1113326 Medium

1113327 Large



1110782 Delta™ Arc Flash Harness

With 7,000-lb. (3175 kg) nylon web, vest style, back web loop, quick-connect buckles, leather insulators, rescue loops. (XLarge)

1110788 Small

1110780 Medium

1110781 Large



1110842 ExoFit™ Arc Flash Harness - Dorsal/Rescue Web Loops

Back and front web rescue loops, comfort padding with Nomex®/Kevlar® fiber, nylon web, leather insulators, quick-connect buckle leg straps. (XLarge)

1110964 Small

1110840 Medium

1110841 Large



3M™ DBI-SALA® Rescue Harnesses (continued)

1113348 ExoFit NEX™ Rope Access and Rescue Harness

Repel™ Web, Tech-Lite™ Aluminum Front, Back and Side D-Rings, Duo-Lok™ Quick-Connect Buckles and hybrid comfort padding.

1113345 Small

1113346 Medium

1113347 Large



1113786 ExoFit NEX™ Rope Access/ Rescue Harness

PVC-coated aluminum front, suspension, and back D-rings, locking quick-connect buckles, Nylon/Kevlar® fiber web, Kevlar® fiber hybrid padding, leather insulators (size XLarge), with 100% top grain leather 2D Lineman Belt. (Size D26)

1113768 Small D21

1113774 Medium D23

1113781 Large D25



1113373 ExoFit NEX™ Black-out Rope Access and Rescue Harness

Repel™ Web, Tech-Lite™ Aluminum Front, Back and Side D-Rings, Duo-Lok™ Quick-Connect Buckles and hybrid comfort padding.

1113370 Small

1113371 Medium

1113372 Large



1150414 ExoFit NEX™ Rope Access and Rescue Harness Seat

Wide sturdy seat for added stability & mobility when working in suspension.



3M™ DBI-SALA® Self-Rescue Device

When the clock's ticking, you need a rescue plan you can count on to rescue you quickly and efficiently. The Self-Rescue Device is your rescue plan. This flexible device attaches to your current safety harness and allows you to lower yourself to safety in the event of a fall from height.

3320030 Self-Rescue Device - 50 ft.

Height: 19 in., Width: 7 in.,
Depth: 2-1/2 in., 50 ft. of
5.5 mm rope.

3320031 Self-Rescue
Device - 100 ft.

3320037 Self-Rescue
Device - Trainer



3M™ DBI-SALA®

Rollgliss™ R550 Rescue and Descent Device

Keep rescues simple with the light, compact and easy-to-use R550 device. It offers the choice of rescue, evacuation, or the versatility of assisted rescue with lifting capabilities. Kits include a Rescue Wheel, Anchor Sling, 2 Carabiners and a Carrying Bag.



Model #	Length
3327050	50 ft. (16m)
3327100	100 ft. (30.5 m)
3327150	150 ft. (46 m)
3327200	200 ft. (61 m)
3327275	275 ft. (84 m)
3327300	300 ft. (92 m)

Accessories

2100093
Rescue Hook and Hot Stick Adapter Tool*

2100111
Hot Stick Adapter Tool only*

*Items should be used with Hot Stick Pole



Emergency Escape:

- Secure R550 Device to anchor point
- Connect the snap hook to dorsal or front D-ring of harness
- Descend safely to the ground

Assisted Rescue:

- Secure R550 Device to anchor point
- Get into position above the victim
- Attach snap hook to victim
- Raise victim to unhook their fall arrest gear
- Descend victim safely to the ground

Pick-off Rescue:

- Use when a victim is out of reach
- Secure R550 Device to anchor point and lower a second rescuer to victim
- Attach victim to rescuer
- Raise victim to unhook their fall arrest gear
- Descend both rescuer and victim to safety

Custom Rescue:

- The R550 Device can be used for custom rescues, like an angled descent
- Secure R550 to anchor point on or near the ground
- Run the rope up through a pulley above the victim
- Raise victim to unhook their fall arrest gear
- Lower the victim to the ground, away from structure

Always read and follow all user instructions.

3M™ DBI-SALA® Descenders

8700387 Double Stop Descender

Anodized gold
aluminum, for
10.5-12.0 mm rope.



8700388 Double Stop Descender

Anodized blue/
gold aluminum,
12.5-13.0 mm rope.



3M™ DBI-SALA® Rigging Plates

2189999 Rigging Plate

Paw-shaped, five,
anodized gold.



2189997 Rigging Plate

Small triangle, six,
anodized gold.



3M™ DBI-SALA® Carabiners and Quick Links

8700168 Rescue Carabiner*

Small offset D,
aluminum 5/8 in.
(16 mm), 6,750-lb.
(30 kN) screw gate.



8700198 Rescue Carabiner*

Medium offset D,
aluminum 7/8 in.
(22 mm), 8,100-lb.
(36 kN) screw gate.



2000025 Rescue Carabiner*

Medium offset D,
aluminum 7/8 in.
(22 mm), 8,100-lb.
(36 kN) auto-locking
screw gate.



*Carabiners do not meet ANSI standards.

3M™ DBI-SALA® Pulleys

8700012 Single Aluminum Pulley

1.5 in. (40 mm) up
to 7/16 in. (11 mm)



8700013 Prusik- Minding Single Aluminum Pulley

1.5 in. (40 mm) up
to 7/16 in. (11 mm)

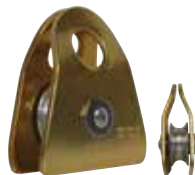

3M™ DBI-SALA® Swivel & Gear Roll

8700144 Swivel

Minimum breaking strength: 9,000 lbs. (40 kN)



3M™ DBI-SALA® Haul Kits

8701100 Micro Haul Kit

Mechanical advantage: 6:1
Working length: 6.5 ft. (2 m)
Rope size: 5/16 in. (8 mm)
Working load limit: 660 lbs. (300 kg)



8704104 Auto Lock Haul Kit

Mechanical advantage: 4:1
Working length: 33 ft. (10 m)
Rope size: 7/16 in. (11 mm)
Working load limit: 660 lbs. (300 kg)



3M™ DBI-SALA® Rollgliss™ Rescue Pick-Off Strap

8700578 Rollgliss Rescue Pick-Off Strap with Polyester Web

Adjustable length is intended for assisted rescue and industrial applications



8700577 Rollgliss Rescue Pick-Off Strap with Kevlar® Fiber Webbing

Adjustable length is intended for assisted rescue and industrial applications



3M™ DBI-SALA® Rope Bags

Part #	Total Space	7/16 in. (11 mm) Rope Capacity	1/2 in. (13 mm) Rope Capacity
8700225	1,525 cu in. (25 L)	164 ft. (50 m)	82 ft. (25 m)
8700222	2,440 cu in. (25 L)	328 ft. (100 m)	164 ft. (50 m)
8700223	3,050 cu in. (25 L)	655 ft. (200 m)	328 ft. (100 m)
8700224	3,660 cu in. (25 L)	980 ft. (300 m)	655 ft. (200 m)



3M™ DBI-SALA® Ascenders

8700118 Left-Hand Ascender

Rope size: 7/16 in.-1/2 in. (10.5-13 mm)



8700119 Right-Hand Ascender

Rope size: 7/16 in.-1/2 in. (10.5-13 mm)



8700522 Chest Ascender

Gold, retrofit. Rope size: 7/16 in.-1/2 in. (10.5-13 mm)



3M™ DBI-SALA® Ladders

1219020 5-Step Etrier Webbing

6 ft. (1.8 m)
1219006 Adjustable up to 6 ft. (1.8 m)



8516294 Rollgliss™ Rescue Ladder

This Ladder provides a way to assist rescue after a fall has occurred. It can be anchored to a structure and dropped down to the victim's level, so they can climb either up or down to safety. The ladder can be used by any able-bodied victim not incapacitated by the fall.

- Available in 8 ft. (2.4 m) sections.
- Extra sections can be added together for longer length.
- Includes three carabiners for attachment.



UPC and Part Number Index

UPC/SKU	Page #	UPC/SKU	Page #	UPC/SKU	Page #
234071.....	24	1110882.....	25	1234071.....	22
244614.....	27	1110883.....	25	1234071.....	24
1001379.....	23	1110890.....	25	1234080.....	22
1001380.....	23	1110891.....	25	1234082.....	22
1001381.....	23	1110892.....	25	1234083.....	22
1001382.....	23	1110893.....	25	1244610.....	26
1001383.....	23	1110964.....	37	1244611.....	26
1001384.....	23	1113315.....	24	1244632.....	26
1001386.....	23	1113316.....	24	1244633.....	27
1001387.....	23	1113317.....	24	1244639.....	26
1001388.....	23	1113318.....	24	1246012.....	35
1001389.....	23	1113320.....	37	1246304.....	27
1001390.....	23	1113321.....	37	1246305.....	27
1001391.....	23	1113322.....	37	1246306.....	26
1001392.....	22	1113323.....	37	1246309.....	27
1001393.....	22	1113325.....	37	1246317.....	26
1001394.....	22	1113326.....	37	1246323.....	27
1001395.....	22	1113327.....	37	1500005.....	32
1001396.....	22	1113328.....	37	1500007.....	32
1001397.....	22	1113345.....	38	1500009.....	32
1001398.....	22	1113346.....	38	1500010.....	32
1001398.....	24	1113347.....	38	1500015.....	31
1001398.....	24	1113348.....	38	1500027.....	32
1001399.....	22	1113357.....	24	1500028.....	32
1001400.....	22	1113358.....	24	1500029.....	32
1001401.....	22	1113368.....	24	1500030.....	32
1001402.....	22	1113369.....	24	1500031.....	32
1001403.....	22	1113370.....	38	1500032.....	32
1001404.....	22	1113371.....	38	1500033.....	32
1001450.....	23	1113372.....	38	1500034.....	32
1001451.....	23	1113373.....	38	1500035.....	31
1001452.....	23	1113757.....	24	1500044.....	31
1001453.....	23	1113758.....	24	1500047.....	31
1001454.....	23	1113759.....	24	1500059.....	31
1001455.....	23	1113760.....	24	1500061.....	31
1001456.....	23	1113761.....	25	1500089.....	31
1001457.....	23	1113762.....	25	1500119.....	31
1002200.....	35	1113763.....	25	1500122.....	31
1003000.....	35	1113764.....	25	1500130.....	31
1050017.....	24	1113768.....	38	1500132.....	31
1050028.....	24	1113774.....	38	1500133.....	30
1100784.....	25	1113781.....	38	1500134.....	30
1103085.....	24	1113786.....	38	1500135.....	30
1103086.....	24	1150058.....	25	1500136.....	30
1103087.....	24	1150414.....	38	1500137.....	30
1103088.....	24	1200110.....	21	1500138.....	30
1110750.....	25	1200111.....	21	1500139.....	30
1110751.....	25	1200115.....	21	1500140.....	30
1110752.....	25	1200136.....	21	2000025.....	40
1110754.....	25	1202794.....	35	2000112.....	29
1110773.....	25	1204057.....	20	2000112.....	35
1110774.....	25	1204057.....	24	2100093.....	39
1110780.....	37	1204058.....	20	2100111.....	39
1110781.....	37	1204074.....	21	2100418.....	35
1110782.....	37	1204075.....	21	2100419.....	35
1110783.....	25	1204075.....	24	2100420.....	35
1110788.....	37	1204076.....	21	2100425.....	35
1110840.....	37	1204077.....	21	2104810.....	35
1110841.....	37	1219006.....	41	2189997.....	40
1110842.....	37	1219020.....	41	2189999.....	40
1110880.....	25	1234030.....	22	3101526.....	29
1110881.....	25	1234070.....	22	3101527.....	29

UPC/SKU	Page #	UPC/SKU	Page #	UPC/SKU	Page #
3101528.....	29	8700222.....	41	10-009304-59372-0.....	13
3101529.....	29	8700223.....	41	10-009304-59372-1.....	13
3101530.....	29	8700224.....	41	10-009304-59372-4.....	13
3101531.....	29	8700225.....	41	10-009304-59372-7.....	13
3101532.....	29	8700387.....	40	10-009304-59372-8.....	13
3101533.....	29	8700388.....	40	10-009304-59801-8.....	13
3101534.....	29	8700522.....	41	10-078371-11872-0.....	4
3101535.....	29	8700577.....	41	10-078371-64197-6.....	5
3101536.....	29	8700578.....	41	10-078371-65550-8.....	5
3101537.....	29	8701100.....	41	10-078371-82501-7.....	4
3101538.....	29	8704104.....	41	10-078371-82502-4.....	4
3101539.....	29	9502776.....	35	10-078371-82701-1.....	4
3101540.....	29	9505712.....	25	10-078371-82782-0.....	4
3101562.....	29	9509844.....	21	100-78371-11872-0.....	7
3101563.....	29	9511049.....	24	100-78371-11873-7.....	7
3101565.....	29	9511049.....	24	100-78371-11874-4.....	7
3101574.....	29	9511597.....	35	50-005113-10700-9.....	16
3101575.....	29	51131373396.....	19	50-005113-10702-2.....	14
3103175.....	29	51131373747.....	19	50-005113-10702-9.....	14
3103275.....	29	51141567419.....	18	50-005113-10718-6.....	16
3320030.....	38	10-007837-11181-8.....	8	50-005113-12718-3.....	9
3320031.....	38	10-007837-11187-0.....	8	50-005113-12718-6.....	9
3320037.....	38	10-007837-16203-9.....	8	50-005113-13719-9.....	17
3327050.....	39	10-007837-16204-6.....	7	50-005113-14948-1.....	14
3327100.....	39	10-007837-16204-9.....	7	50-005113-14949-4.....	14
3327150.....	39	10-007837-16205-0.....	7	50-005113-14949-8.....	14
3327200.....	39	10-007837-16210-3.....	8	50-005113-58942-2.....	15
3327275.....	39	10-007837-16210-6.....	8	50-005113-58942-3.....	15
3327300.....	39	10-007837-16211-1.....	7	50-005113-82151-3.....	16
3400840.....	36	10-007837-16211-4.....	7	50-005113-82167-5.....	15
5000335.....	35	10-007837-16211-8.....	7	50-005113-82900-0.....	10
5000400.....	35	10-007837-16214-3.....	9	50-005113-84645-3.....	16
5002055.....	35	10-007837-16217-4.....	9	50-005113-84646-2.....	15
5900550.....	35	10-007837-16217-7.....	9	50-005113-84646-8.....	15
5901583.....	35	10-007837-16223-7.....	8	50-005113-85414-0.....	17
6100035.....	35	10-007837-16261-6.....	8	50-005113-85414-4.....	17
6100136.....	35	10-007837-16555-5.....	5	50-005113-85414-5.....	15
7605060.....	34	10-007837-16571-2.....	6	50-005113-85415-5.....	15
8000000.....	36	10-007837-16571-5.....	6	50-005113-85418-8.....	15
8102001.....	36	10-007837-16579-4.....	5	50-005113-85428-1.....	17
8102003.....	36	10-007837-16579-7.....	5	50-005113-85429-0.....	16
8102005.....	36	10-007837-16621-4.....	6	50-005113-85434-8.....	17
8102007.....	36	10-007837-16621-7.....	6	50-005113-85437-4.....	17
8102009.....	36	10-007837-16674-0.....	9	50-051131-27566-4.....	5
8102011.....	36	10-007837-16674-3.....	9	50-051131-27567-1.....	5
8102050.....	36	10-007837-16674-7.....	9	50-051131-27568-8.....	5
8516294.....	41	10-008052-91000-6.....	10		
8516691.....	33	10-008052-91005-8.....	10		
8516692.....	34	10-008052-91101-1.....	12		
8516693.....	33	10-008052-91103-0.....	11		
8516996.....	33	10-008052-91103-7.....	11		
8516997.....	34	10-008052-91105-3.....	11		
8517422.....	34	10-008052-91201-2.....	11		
8517565.....	34	10-008052-91800-5.....	12		
8530352.....	36	10-008052-91801-4.....	12		
8700012.....	40	10-008052-92101-8.....	12		
8700013.....	40	10-008052-94000-4.....	12		
8700118.....	41	10-008052-94000-8.....	12		
8700119.....	41	10-008052-94004-7.....	13		
8700144.....	40	10-009304-50807-4.....	13		
8700168.....	40	10-009304-50810-8.....	13		
8700198.....	40	10-009304-59295-5.....	12		

Product-Related Seminars & Support

Respiratory Fit Testing & Training Information

The Occupational Safety and Health Administration (OSHA) General Industry Standard for Respiratory Protection 29 CFR 1910.134 requires employers to have a written respiratory protection program in place. This program typically includes medical evaluations and respiratory fit testing. 3M helps you achieve regulatory compliance with a range of services focused on OSHA requirements. These include customized online respiratory medical evaluations to help optimize compliance testing and tracking; product selection tools; instructional tools for conducting OSHA required product usage training; and cartridge service life software to help keep you in compliance.

Powered & Supplied Air Training Tools

Gain a fuller understanding of how to use and care for your powered and supplied air respiratory protection equipment.

This series includes training videos, posters and literature providing information on how to clean, assemble and maintain your system.

Hearing Conservation Seminars

3M offers free on-site employee educational seminars focused on hearing conservation. Topics include current regulations, equipment choices, employee training programs, and issues related to noise hazards and hearing protection. Content is provided for both plant managers and workers. Seminars are conducted nationwide by 3M's team of HearForce™ CAOHC certified managers. Hearing conservation technicians and occupational health professionals seeking certification as an Occupational Hearing Conservationist (OHC) can also attend Hearing Conservation courses that 3M helps facilitate at Minnesota's Midwest Center for Occupational Health and Safety and throughout the country.

Online Respirator Medical Evaluations

- Using any computer with Internet access, the employer creates one or more Respirator Profiles describing the respirator type, the work being done and the conditions under which the respirator(s) is used.
- Each employee logs on to a secure website using a unique personal password. The employee then fills out the online questionnaire and submits it for evaluation.

- The employee receives immediate notification of his/her respirator use status.
- Within minutes after the employee has completed the questionnaire, the employer can find out the respirator use status of those employees.
- Employees and the employer are notified within one (1) business day after completion of the questionnaire regarding status of any employees requiring further evaluation.
- All data is stored behind a firewall on a secure server. The employer does not have access to the employees' private health information.

Educational Seminars Available:

- Occupational Noise Exposure Measurement (1 day)
- Noise and Heat Stress Measurements, A Best Practice Approach (1/2 day)
- Heat Stress Management and Control (1/2 day)
- Detection University – Noise, Heat Stress and Indoor Air Quality Instrumentation Training (4 days)

3M also offers calibration and repair service for our line of occupational and industrial hygiene instrumentation. Many of our products are used in potentially explosive atmospheres and require strict adherence to our original proprietary design specifications for service and repairs. Accredited calibrations are important as they provide validation of data if challenged by third parties. They also ensure that intrinsic safety has not been compromised, and offer confidence in the technical sufficiency of the calibration.

3M.com/PPESafety or m.3M.com/PPESafety

3M's websites are available 24/7 and provide extensive information, resources, video and technical data for you and your customers.

Distributor Portal: 3M.com/PSDDistributor

Other direct links to product specific web pages:

Respiratory

3M.com/Respiratory

Resources on this site include: Six-Step Respiratory Protection Program, Respirator Selection Guide Software, Cartridge Replacement Program Documents and Information, Hazards In The News, Filter Replacement Program, and more.

Hearing Conservation

3M.com/Hearing

Resources on this site include: Hearing conservation training videos for workers, technical resources on hearing protector fit testing, 3M™ E-A-R Log™ Technical Monographs Series, Audio Demonstration Webinars, Noise Navigator™ Sound Level Database, Training Audios and Hearing Loss Prevention Seminars.

For posters, DVDs, tech data bulletins, training videos and product samples

3M.com/PPESafety

Welding

3M™ Speedglas™ Products Homepage:
3M.com/Speedglas
Welding Student & Educator Portal:
3M.com/WeldingSafety

Fall Protection

3M.com/FallProtection

Detection & Monitoring

3M.com/Detection

Protective Apparel

3M.com/ProtectiveCoveralls

Versaflo™ Air Respirators

3M.com/Versaflo

3M™ Scotchlite™ Reflective Material

www.Scotchlite.com

Occupational Health Construction Page

3M.com/WorkerSafety

HexChrome Website

3M.com/HexChrome

YouTube®

youtube.com/3MPPEsafetySolutions

Facebook® – 3M™ Speedglas™ Welding

facebook.com/Speedglas

JobHealth Highlights Newsletter

3M.com/JHH

3M Safety Training Courses

3M Safety training is available for half or full-day training on a variety of topics related to respiratory, hearing, eye, welding and fall protection equipment applications. Contact your 3M Sales Representative or call us at 1-800-328-6146 (Opt. 8)



⚠WARNING

Respiratory Products (see pages 14-18)

These respirators help protect against certain airborne contaminants. Before use, the wearer must read and understand the *User Instructions* provided as a part of the product packaging. A written respiratory protection program must be implemented meeting all the requirements of OSHA 1910.134 including training, fit testing and medical evaluation. In Canada, CSA standards Z94.4 requirements must be met and/or requirements of the applicable jurisdiction, as appropriate. **Misuse may result in sickness or death.** For correct use, consult supervisor and *User Instructions*, or call 3M PSD Technical Service in the USA at 800-243-4630. In Canada, call Technical Service at 800-267-4414.

⚠WARNING

Hearing Protection Products* (see pages 10-13)

Choking Hazard—Keep earplugs away from infants and small children. These hearing protectors help reduce exposure to hazardous noise and other loud sounds.

Misuse or failure to wear hearing protectors at all times that you are exposed to noise may result in hearing loss or injury. For proper use, see supervisor, *User Instructions*, or call 3M PSD Technical Service in the USA at 800-243-4630. In Canada, call PSD Technical Service at 800-267-4414. If there is any drainage from your ear or you have an ear infection, consult with your physician before wearing earplugs. Failure to do so may result in hearing loss or injury. 3M strongly recommends fit testing of hearing protectors. If the NRR is used to estimate typical workplace protection, 3M recommends that the NRR be reduced by 50% or in accordance with applicable regulations. See User Instruction insert for more information.

*Research suggests that many users will receive less noise reduction than indicated by the NRR due to variation in earplug fit and wearing time. It is recommended that the NRR be reduced by 50% for estimating the average amount of noise reduction provided.

⚠WARNING

Eye and Face Products (see pages 6-9)

These eye and face protection products help provide limited eye and face protection. **Misuse or failure to follow warnings and *User Instructions* may result in serious potential injury, including blindness or death.** For proper use, selection, and applications against flying particles, optical radiation and/or splash, see Supervisor, read *User Instructions* and warnings on the package or call 3M PSD Technical Service in the USA at 800-243-4630. In Canada, call Technical Service at 800-267-4414.

⚠WARNING

Hard Hats (see pages 4-5)

3M™ Hard Hats help provide limited protection only. **Misuse or failure to follow warnings and *User Instructions* may result in serious personal injury or death.** For proper use, see Supervisor and *User Instructions*, or call 3M PSD Technical Service in the USA at 800-243-4630. In Canada, call Technical Service at 800-267-4414.

⚠WARNING

Fall Protection Products (see pages 20-41)

Compliant fall protection and emergency rescue systems help prevent serious injuries associated with fall events. Users must read and understand the *User Instructions* provided with the product, and must be properly trained by their employers in the safe use of these systems before using them, per OSHA 1910.66 and 1926.503 or applicable local standards. **Misuse or failure to follow warnings and instructions may result in serious personal injury or death.** For proper use, see supervisor, *User Instructions*, or call 800-328-6146 (Opt. 1).



Carhartt® exclusively produces high-visibility, FR garments using 3M Scotchlite™ Reflective Material.



3M Personal Safety Division
3M Center Building 235-2W-70
St. Paul, MN 55144-1000
3M.com/PPESafety

3M Fall Protection Business
Personal Safety Division
3833 SALA Way
Red Wing, MN 55066 USA
3M.com/FallProtection

3M, DBI-SALA, PELTOR, BX, Delta, Duo-Lok, E-A-R, E-A-Rfit, E-A-Rform, E-A-Rsoft, ExoFit, ExoFit NEX, EZ-Line, EZ-Stop, Flexiguard, Force2, Fuel, Lad-Saf, Lexa, Light Vision, Maxim, Moon Dawg, Nano-Lok, Repel, Rollgliss, Saflok, Seat-Belt, SecureFit, Shockwave, Smart Lens, Solus, SuperFit, Ultra-Lok, Versaflo, Virtua, Yellow Neons, Blasts, Classic, EXPRESS, Optime, Pod Plugs, Salalift, Skull Screws, TaperFit, Tech-Lite, Tri-Flange, UltraFit and UltraFit Plus are trademarks of 3M Company and its affiliates.

© 3M 2016.

Carhartt is a registered trademark of Carhartt, Inc. Kevlar and Nomex are registered trademarks of Dupont. Technora is a registered trademark of Teijin Kabushiki Kaisha (Teijin Limited).