



Fall Protection

3M™ DBI-SALA® Full Line Catalog | Fall 2016

**Elevating safety
to new heights.**



United States

The sky's the limit.

How do you build a legacy? The same way we build everything: with confidence, from the ground up. For years, at-height workers around the world have trusted DBI-SALA® to help them get the job done confidently and get home safely. Our first-to-market innovations and high-performance solutions have earned us a reputation as the experts in fall protection and rescue. Today, as part of the 3M Personal Safety Division, we're better equipped than ever to continue investing in technology and products that enhance worker safety, productivity and comfort.

So the next time you gear up and climb with 3M™ DBI-SALA®, remember that there's no limit to how far we'll go to keep you safe.



The ABC's of fall protection

A typical Personal Fall Arrest System (PFAS) incorporates three components, often described as the ABC's of fall protection. The anchorage/anchorage connector, body support and connecting device—when used together—form a complete system for maximum worker protection. But don't forget the other important components of a comprehensive fall protection program: descent and rescue, education and fall protection for tools.



A

Anchorage

are a secure point of attachment. Anchorage connectors vary by industry, job, type of installation and structure. They must be able to support the intended loads and provide a sufficient factor of safety for fall arrest.

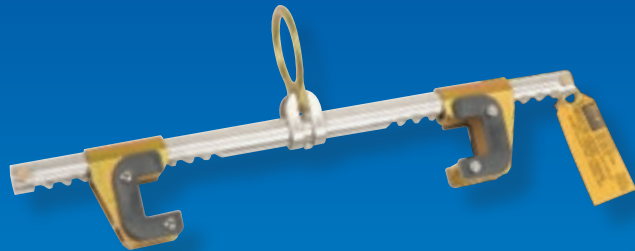

B

Body support

harnesses distribute fall forces over the upper thighs, pelvis, chest and shoulders. They provide a connection point on the worker for the personal fall arrest system.

C

Connectors

such as shock-absorbing lanyards or self-retracting lifelines connect a worker's harness to the anchorage.





D

Descent and rescue

devices are used to raise or lower a fallen injured worker to safety or retrieve him from a confined space.

E

Education

is essential. We offer a variety of training and consultative services to fit your needs.

F

Fall protection for tools

helps make work environments safer and more productive by reducing dropped object incidents.

Table of contents

Full-body harnesses.....	12-43
Belts, workseats and accessories.....	44-45
Fall protection for tools.....	46-71
Shock-absorbing lanyards.....	72-83
Positioning lanyards.....	84-85
Self-retracting lifelines.....	86-99
Vertical systems.....	100-113
Horizontal systems.....	114-121
Engineered systems.....	122-127
Anchorage connectors.....	128-141
Flexiguard™ Solutions.....	142-155
Confined space rescue.....	156-175
Rescue and descent.....	176-191
Netting and guardrail systems.....	192-201
Part number and page index.....	202-210



We've worked in your industry for decades.

We climb the rigs in the oil and gas fields. We straddle the I-beams on construction sites. We attend the 5 a.m. toolbox safety discussions with transportation personnel. And we review tie-off challenges on top of wind turbine nacelles hundreds of feet in the air.

At 3M Fall Protection, we work hard to understand the challenges you face before we design your equipment. That's how we go beyond compliance to produce the broadest, most innovative, high quality fall protection equipment for the world's most vital industries.



Wind energy

To address safety needs in this growing industry, we created specialized 3M™ DBI-SALA® ExoFit NEX™ Wind Energy Harnesses and Force2™ Lanyards, as well as unique rescue and escape systems such as the Rollgliss™ R550.



Transportation

We developed dozens of specialized products, from Uniline™ Horizontal Systems for railcar loading, to custom access Flexiguard™ Solutions for semi-truck servicing. We've even designed a patented fall arrest-rated Mobi-Lok™ Self-Contained Vacuum Anchor System for aviation workers.



We've been
where you're
going.



Oil and gas

We pioneered “retractable” lifeline technology in the 1940s, “sealed retractable” technology specifically for the oil and gas fields, and products tested to -55°F to meet the IP68 seal rating. In addition, we developed specialized equipment and training for a wide array of emergency escape devices.

Mining

We developed specialized harnesses to address miners’ specific needs as well as 3M™ DBI-SALA® Flexiguard™ Solutions to protect them while doing maintenance on oversized mining industry trucks. Additionally, our industry-leading mining anchors maximize versatility and ease-of-use for workers.



Construction

No two construction sites are the same. That complexity is why we work closely with contractors to help us fine-tune our design on key products such as the 3M™ DBI-SALA® Nano-Lok™ edge Self-Retracting Lifeline—used at sites where sharp edges are hazardous and foot level tie-off is needed.

We listened to steel erectors and created shoulder caps that protect the webbing on our latest harnesses. Our EZ-Line™ Horizontal Lifeline System is extremely user-friendly and features the world's only retractable design.

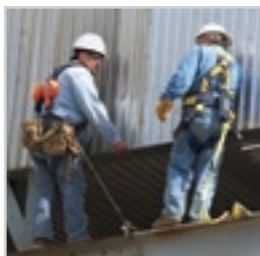

General industry

Every day, thousands of manufacturing and facility workers around the world don their safety gear and head out to do their job. Whether you're processing, milling, finishing, inspecting or doing routine maintenance, 3M Fall Protection has you covered. Our specialty Advanced Confined Space Equipment, Nano-Lok edge Self-Retracting Lifelines, ExoFit™ STRATA™ and ExoFit NEX™ Harnesses, ShockWave™ Lanyards, Lad-Saf™ Ladder Safety Systems and innovative guardrail and netting products are just a few of the many solutions we offer.



Utility, telecom and municipalities

We proactively innovate equipment specifically for these unique industries, like our Advanced Confined Space Equipment and our Cynch-Lok™ and Safflok™ Pole Anchors. Our arc flash products feature Kevlar®/Nomex® fibers and include the first arc flash self-retracting lifeline. Our redesigned SEAT-BELT™ Lineman Belt is made with 100% top grain leather from Red Wing, MN.





Our site or yours.

Training

anytime, anywhere.

Workers' lives are on the line every day, but ensuring their safety starts long before the job begins. No one understands this better than 3M Fall Protection. Our training is based on more than 70 years of expertise and jobsite implementation around the globe.

When it comes to protecting your work site, we deliver. We offer superior courses in world-class training facilities, based on standard curriculums or custom programs specific to your jobsite. Our comprehensive training provides practical, hands-on experience, including: scaffolding, fixed ladders, towers, sloped roofs, rebar walls, elevated catwalks, I-beams and confined spaces. Every course we offer exceeds industry standards set by OSHA, MSHA, ANSI, CSA and CE.

Open enrollment courses

are designed to a standard that ensures you are trained competently.

- Competent person
- Competent person trainer
- Equipment inspector
- Program administrator
- Competent climber & rescuer
- Authorized person
- Qualified person
- Competent person refresher
- Wind energy competent rescuer
- Wind energy competent rescuer trainer
- Confined space entrant/supervisor
- Confined space rescue
- Confined space trainer
- Competent industrial rescuer
- Competent tower rescue



3M Fall Protection offers a full range of fall protection and industrial rescue courses at our state-of-the-art training centers. In the US, these are located in Red Wing, MN, Houston, TX and our newest facility in Orange County, CA.

We also offer on-site training at your facility. By teaching in and around workers' regular, everyday environments, we are able to ensure the issues discussed are immediately applicable. Please contact us for more information.



Fall protection awareness demonstrations

Our North American fleet of nearly 50 specialized vehicles can bring on-site, hands-on fall protection demonstrations to your workforce. We demonstrate actual drop-tests with force measuring instruments so workers are familiar with the arresting forces they may experience during a fall. This provides an excellent introduction to fall protection.

Safety on demand

We understand how important safety is to our clients. As part of our commitment to safety and health, we have created an eLearning option, specifically for you to have easy access to information that will help employees stay safe and injury free. Your employees can access courses at the moment of need, 24/7, and quickly apply it on the job. What does that mean for your business? Higher levels of engagement, improved safety and performance, and a higher retention rate.

Industry-specific and custom courses

3M Fall Protection will also customize courses for you. Training is tailored to your site and workers and the hands-on scenarios actually resolve fall protection hazards in and around your facility.

Our range of industry-specific training courses include Oil Field Rig Workers Awareness, Rig Rescue, Tower Climbing/Rescue, Confined Space Entry and Retrieval and more.





Full-Body Harnesses

Just how important
is choosing the
right harness?

When you're 75 feet off the ground, your harness is more than just your safety connection—it's everything. Your comfort, confidence, productivity and versatility on the job are all directly connected to the quality of its design and craftsmanship.

That's why every 3M™ DBI-SALA® Harness—like ExoFit™ and Delta™—is designed to enhance the quality of your work from every angle. Spring-loaded, stand-up back D-rings that are easier to use. No-Tangle Pads and Revolver™ Torso Adjusters that optimize fit and mobility. The LIFTech™ Load Distribution System that made ExoFit™ STRATA™ the most comfortable, lightest-wearing safety harness we've ever created.

Whether you work in one industry or many, many of our harnesses can be used on a wide variety of jobs. We also manufacture harnesses for specific uses within Construction, Oil and Gas, Transportation, Utilities/Telecommunications and Municipalities and Wind Energy.

The following pages contain both general and specific use harnesses. All harnesses meet OSHA and ANSI standards, including the stringent ANSI Z359.11.



Choosing your harness

Look for quality in these features when selecting your harness.

1 Dorsal connection

The fall arrest attachment point must be located on the back, positioned between the shoulder blades. Your harness must always include a dorsal attachment point, but some may also allow you to attach SRLs without pulling up the webbing or impeding use of the D-ring, like with our EZ-Link™ Technology.



2 Webbing

Webbing is an important factor in the durability and safety of the harness. Ensure that the webbing is strong enough to endure rough use, exposure to sunlight and other elements without tearing or fraying. Specialty applications such as welding and electrical maintenance require the use of Nomex®/Kevlar® fibers or nylon that offers fire resistance or arc flash protection.

3 Adjusting points

Whether you wear a harness four hours a day or 14, it needs to fit right for safety and comfort. Harnesses with adjusting points on the legs, waist (belt models), chest and torso allow a better fit.

4 Leg straps

Depending on worker preference, leg strap fasteners may be available in different styles, including:



Tongue Buckle



Pass-Through Buckle



Quick-Connect Buckle

5 Pelvic support

A sub-pelvic strap provides additional support, security and comfort for the user. Properly positioned, it better distributes forces during a fall.



6 Book-style labels

Book-style labels put product and inspection information at the workers' fingertips. Pages may include sizing, operating instructions, inspection log, warning labels and compliance information. These labels promote quick inspection, compliance and safety.



7 Stitching

Double box stitching provides maximum strength and durability. It's sewn-in quality you can trust.



8 Padding

Cushioned shoulder, leg and hip pads keep the pressure off, providing extra worker comfort for long hours of wear. In a fall, they absorb shock and help distribute your weight. They may be built-in to avoid slipping or may be removable.

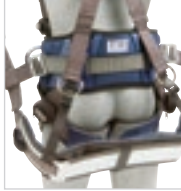

9 Seat slings

A removable seat sling provides job versatility and added comfort during long hours of use.

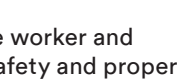

10 Impact indicators

Impact indicators provide immediate notice that the worker and harness have been in a fall. This feature promotes safety and proper inspection.



11 Lanyard keepers

A lanyard keeper provides a place to park your lanyard when not in use. It prevents tripping and entanglement for enhanced safety.



12 Breathable linings

Breathable linings, like those found in ExoFit™ Harnesses, wick moisture away from your body, so you stay dry and comfortable in heat or cold.

13 Trauma straps

Suspension trauma straps are easily deployed and hook together in seconds, allowing you to stand up while suspended in harness with one or both feet to relieve leg trauma.

3M DBI-SALA Full-Body Harness Sizing Chart

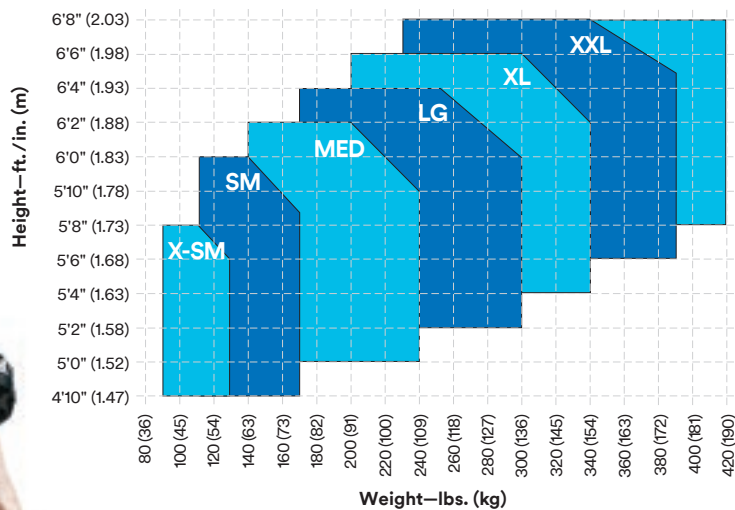

Which 3M DBI-SALA Harness is right for you?

ExoFit™ STRATA™ | The light-wearing full-body harness that's ideal for those who wear personal SRLs. (See page 16)

ExoFit NEX™ | The gold standard in comfort, function and durability. (See page 20)

ExoFit™ | The original comfort harness. (See page 30)

Delta™ Comfort | A full-body harness that's comfortable and dependable. (See page 34)

Delta™ | The workhorse of the industry: Durable, convenient and comfortable. (See page 36)

Types of harnesses

3M™ DBI-SALA® Harnesses are available in different types, with various features, depending on their intended use.



Multi-purpose harness

This type typically includes extra attachment points which allow work in a variety of situations. The belt and pad provide additional back lumbar support, positioning rings and tool carrying options.



Work positioning harness

These harnesses have positioning D-rings located on the hips for use with pole straps or work positioning lanyards, which allow hands-free operation. Harnesses of this kind may include integral waist belts.



Ladder climbing harness

Harnesses with a frontal attachment point, for connection to permanent ladder safety systems.



Descent control harness

These harnesses typically have frontal attachment points for use with descent control devices.



Confined entry/retrieval harness

One attachment point located on each shoulder strap facilitates upright retrieval from confined spaces.



Suspension/rigging harness

These harnesses typically include extra attachment points such as back, front and side D-rings, which allow use in a variety of climbing, positioning, descent and rescue applications.

3M™ DBI-SALA® ExoFit™ STRATA™ Full-Body Harness

The safety harness that won't weigh you down.

“Lighten up.” It's what at-height workers have been trying to do for decades. That's why we created the 3M DBI-SALA ExoFit STRATA Full-Body Harness. It features a first-of-its-kind load distribution system that literally takes the weight off workers' shoulders, resulting in a harness that is more comfortable, cooler and lighter to wear.

- 1 Tech-Lite™ Aluminum Side & Dorsal D-Rings
Secure your safety

Maximize reliability without adding extra weight.

- 2 EZ-Link™ Quick SRL Adapter
Gets you connected quickly

Simplifies connecting and disconnecting your personal self-retracting line.

- 3 LIFTech™ Load Distribution System
Frees your shoulders

Redistributes the weight of the harness to your center of gravity to dramatically reduce fatigue.

- 4 PolarMesh™ Padding
Keeps your back cool

Allows greater airflow to your back, providing superior breathability to keep you cool.

- 5 Revolver™ Vertical Torso Adjuster
Unleashes your mobility

Easily stores excess webbing, locking it in place and out of your way while maintaining the perfect fit.

- 6 Tri-Lock Revolver Connectors
Lock down loose ends

Store additional excess webbing and provide an extra layer of security around your legs.



3M™ DBI-SALA® ExoFit™ STRATA™ Construction-Style Harnesses



1112538

ExoFit STRATA Construction-Style Harness

Tri-Lock Revolver™ Buckles, back and side D-rings. (XLarge)

1112535 Small

1112536 Medium

1112537 Large



1112553

ExoFit STRATA Construction-Style Harness

Duo-Lok™ Quick-Connect Buckles, back and side D-rings. (XLarge)

1112550 Small

1112551 Medium

1112552 Large



1112543

ExoFit STRATA Construction-Style Harness

Tri-Lock Revolver Buckles, back, front and side D-rings. (XLarge)

1112540 Small

1112541 Medium

1112542 Large



1112568

ExoFit STRATA Construction-Style Harness

Tongue buckle leg straps, back and side D-rings. (XLarge)

1112565 Small

1112566 Medium

1112567 Large

ExoFit STRATA Tower-Climbing Harnesses

1112583

ExoFit STRATA Tower-Climbing Harness

Tri-Lock Revolver Buckles, aluminum front, back and side D-rings, removable seat sling with positioning D-rings. (XLarge)

1112580 Small

1112581 Medium

1112582 Large



1112588

ExoFit STRATA Tower-Climbing Harness

Tongue buckle leg straps, aluminum front, back and side D-rings, removable seat sling with positioning D-rings. (XLarge)

1112585 Small

1112586 Medium

1112587 Large



Full-Body Harnesses

3M™ DBI-SALA® ExoFit™ STRATA™

Vest-Style Harnesses without LIFTech™



1112478

ExoFit STRATA Vest-Style Harness

Aluminum back D-rings, Tri-Lock Revolver™ Quick-Connect Buckles, comfort padding. (XLarge)

1112475 Small

1112476 Medium

1112477 Large

1112479 2X



1112483

ExoFit STRATA Vest-Style Positioning Harness

Aluminum back and side D-rings, Tri-Lock Revolver Quick-Connect Buckles, comfort padding. (XLarge)

1112480 Small

1112481 Medium

1112482 Large

1112484 2X



1112533

ExoFit STRATA Vest-Style Climbing Harness

Aluminum back, front and side D-rings, tongue buckle leg straps, Tri-Lock Revolver chest strap, comfort padding. (XLarge)

1112530 Small

1112531 Medium

1112532 Large

1112534 2X



1112493

ExoFit STRATA Vest-Style Harness

Aluminum back, front, and side D-rings, Tri-Lock Revolver Quick-Connect Buckles, comfort padding. (XLarge)

1112490 Small

1112491 Medium

1112492 Large

1112494 2X



1112523

ExoFit STRATA Vest-Style Harness

Aluminum back and side D-rings, tongue buckle leg straps, Tri-Lock Revolver chest strap, comfort padding. (XLarge)

1112520 Small

1112521 Medium

1112522 Large

1112524 2X



1112503

ExoFit STRATA Vest-Style Harness

Aluminum back and side D-rings, Duo-Lok™ Quick-Connect Buckles, comfort padding. (XLarge)

1112500 Small

1112501 Medium

1112502 Large

1112504 2X



3M™ DBI-SALA® ExoFit NEX™ Full-Body Harness

The ultimate full-body comfort harnesses

Evolutionary. When you wear a 3M DBI-SALA ExoFit NEX Full-Body Harness, you're wearing one of the most advanced harnesses in the industry. That's because it's the culmination of everything at-height workers loved and everything we learned from creating the ExoFit™ and ExoFit XP, plus the incorporation of enhanced materials and industry-first innovations.

Comfort

True to our NEX mission, we manufacture these harnesses using materials that won't add unnecessary weight.

Function

When speed and efficiency are project requirements, ExoFit NEX will provide the freedom and confidence to function at your maximum potential.

Durability

ExoFit NEX Harnesses are designed using materials that last.

1 Revolver™ Vertical Torso Adjusters

Simple and fast adjustments that eliminate loose ends and lock into place, preventing slippage.

2 Hybrid comfort padding

Lightweight, moisture wicking and breathable padding won't move or slip, always keeping the wearer comfortable.

3 Tech-Lite™ Aluminum D-rings

Extremely lightweight alloy commonly used in military and aerospace offers a higher level of security and comfort.

4 Integrated trauma straps

Provide an adjustable, continuous loop for post fall, minimizing suspension trauma.

5 Duo-Lok™ Quick-Connect Buckles

Lightweight one-handed use with memory-fit web-lock ensures fast, non-slipping connections.

6 Ultra-soft edging

Moves with you. Doesn't rub or chafe.

7 Protective shoulder caps

Provide protection and comfort when carrying heavy materials.

8 Molded lanyard keepers

Easy holstered snap hooks break away to avoid trip hazard.

9 Reflective material

For greater visibility in dark and dangerous environments, reflective material is integrated on legs, chest, shoulders and back.

10 Built-in carrying pocket

Conveniently holds and protects a cell phone, camera or other items.

11 REPEL™ Technology Webbing

Water repellent to reduce attraction of mold and dirt—also has up to 5 times more abrasion resistance.

12 Revolver Vertical Torso Adjusters



13 Stand-up dorsal D-ring

Patented spring-loaded design automatically stands-up, ensuring fast, easy and safe connections to your fall arrest system.



420 lb.
Capacity

Model shown
1113130

Superior X-design

A single piece of material in the shape of an X wraps around the wearer for the ultimate in comfort, security and no-tangle donning.



3M™ DBI-SALA®

ExoFit NEX™

Vest-Style Full-Body Harnesses

Vest-Style Harnesses are the most universal, with multiple configurations and connection point options. They're used across a wide variety of industries.



1113010

ExoFit NEX Vest-Style Harness

Aluminum back D-ring, locking quick-connect buckles. (XLarge)

1113001 Small

1113004 Medium

1113007 Large



1113040

ExoFit NEX Vest-Style Harness

Aluminum front and back D-rings, locking quick-connect buckles. (XLarge)

1113031 Small

1113034 Medium

1113037 Large



1113055

ExoFit NEX Vest-Style Harness

Aluminum back and side D-rings, locking quick-connect buckles. (XLarge)

1113046 Small

1113049 Medium

1113052 Large



1113070

ExoFit NEX Vest-Style Harness

Aluminum back and shoulder D-rings, locking quick-connect buckles. (XLarge)

1113061 Small

1113064 Medium

1113067 Large



1113085

ExoFit NEX Vest-Style Harness

Aluminum front, back and side D-rings, locking quick-connect buckles. (XLarge)

1113076 Small

1113079 Medium

1113082 Large

ExoFit NEX

Crossover-Style Harnesses

A front-mounted D-ring makes the crossover-style ideal as a rescue harness and for ladder climbing applications.



1113100

ExoFit NEX Crossover-Style Harness

Aluminum front and back D-rings, locking quick-connect buckles. (XLarge)

1113091 Small

1113094 Medium

1113097 Large



1113115

ExoFit NEX Crossover-Style Harness

Aluminum front, back and side D-rings, locking quick-connect buckles. (XLarge)

1113106 Small

1113109 Medium

1113112 Large

Full-Body Harnesses

3M™ DBI-SALA®

ExoFit NEX™

Tower Climbing Harnesses

Tower climbing models are built to keep workers comfortable during extended hours in harness. Tool loops are ideal for carrying equipment.

1113193

ExoFit NEX Tower Climbing Harness

Aluminum front, back and side D-rings, locking quick-connect buckles with sewn-in hip pad and belt, removable seat sling with positioning D-rings. (XLarge)

1113190 Small

1113191 Medium

1113192 Large



Back view

A removable seat sling adds even more comfort, for those who wear them all day long.

ExoFit NEX

Construction-Style Harnesses

Made for general construction work, these harnesses have excellent tool-carrying capability, sewn-in hip pad and removable body belt.



Easily adjusted tongue buckle body belt.



Protective hip padding loops prevent equipment pouches from sagging and reduce abrasion in vulnerable areas.



1113130

ExoFit NEX Construction-Style Harness

Aluminum back and side D-rings, locking quick-connect buckles with sewn-in hip pad, removable belt. (XLarge)

1113121 Small

1113124 Medium

1113127 Large



1113160

ExoFit NEX Construction-Style Harness

Aluminum front, back and side D-rings, locking quick-connect buckles, sewn-in hip pad, removable belt. (XLarge)

1113151 Small

1113154 Medium

1113157 Large



1113145

ExoFit NEX Construction-Style Harness

Aluminum back and side D-rings, tongue buckle legs, sewn-in hip pad, removable belt. (XLarge)

1113136 Small

1113139 Medium

1113142 Large

3M™ DBI-SALA®**ExoFit NEX™****Global Wind Energy Harnesses**

People around the world rely on our wind industry harnesses because they meet the major global compliance standards including ANSI, OSHA, CSA and CE.

1113218**ExoFit NEX Global Wind Energy Harness**

Aluminum front, back and side D-rings, locking quick-connect buckles and sewn-in hip pad with belt and lumbar wear protection. (XLarge)

1113215 Small

1113216 Medium

1113217 Large

1113213**ExoFit NEX Global Wind Energy Harness**

Aluminum front, back and side D-rings, locking quick-connect buckles. (XLarge)

1113210 Small

1113211 Medium

1113212 Large

**REPLACEABLE LUMBAR PROTECTOR**

The lumbar protector is easily replaced in the field when worn or damaged.

**RADIO HOLSTER**

Conveniently holds and protects a radio, cell phone, or other items.



Back view

ExoFit NEX**Mining Vest-Style Harnesses**

We've designed these harnesses specifically to allow miners to conveniently carry the equipment they need to get the job done.

1113199**ExoFit NEX Mining Vest-Style Harness**

Aluminum back D-ring, locking quick-connect buckles, integrated hip padding with belt and miner's equipment straps. (XLarge)

1113195 Small

1113196 Medium

1113197 Large



Back view

Full-Body Harnesses

3M™ DBI-SALA® ExoFit NEX™

Oil & Gas Full-Body Harness

The ExoFit NEX Oil & Gas models combine the industry-first innovations of the ExoFit NEX with the additional features developed specifically for the needs of the on- and offshore drilling markets.

1113298

ExoFit NEX Oil & Gas Harness

18 in. D-ring extension, derrick attachments, hip pad & belt with rigid seat sling (XLarge). For use with 1003221 Derrick Belt (order separately).

1113295 Small

1113296 Medium

1113297 Large



Back view

1113293

ExoFit NEX Oil & Gas Harness

18 in. D-ring extension, derrick attachments, quick-connect chest buckle, hip pad & belt with lumbar D-ring and soft seat sling (XLarge). For use with 1000570 Derrick Belt (order separately).

1113290 Small

1113291 Medium

1113292 Large

1113305 Small (pass-through chest buckle)

1113306 Medium (pass-through chest buckle)

1113307 Large (pass-through chest buckle)

1113308 XLarge (pass-through chest buckle)

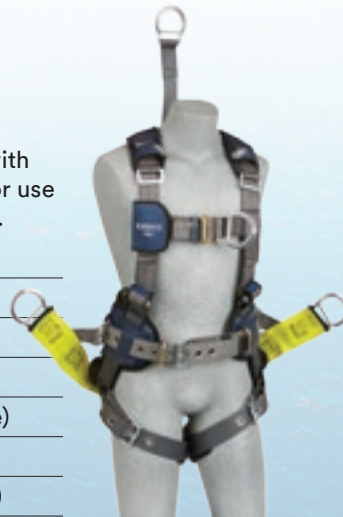

1003222

Derrick Belt

With tongue buckle attachment. (XLarge) (Harnesses sold separately.)

1003230 With tongue buckle attachment (Small)

1003220 With tongue buckle attachment (Medium)

1003221 With tongue buckle attachment (Large)

1000572 With pass-through attachment (Small)

1000573 With pass-through attachment (Medium)

1000570 With pass-through attachment (Large/XLarge)

1113288

ExoFit NEX Oil & Gas Harness

18 in. D-ring extension, derrick attachments, lifting D-rings off hips (XLarge). For use with 1003221 Derrick Belt (order separately).

1113285 Small

1113286 Medium

1113287 Large

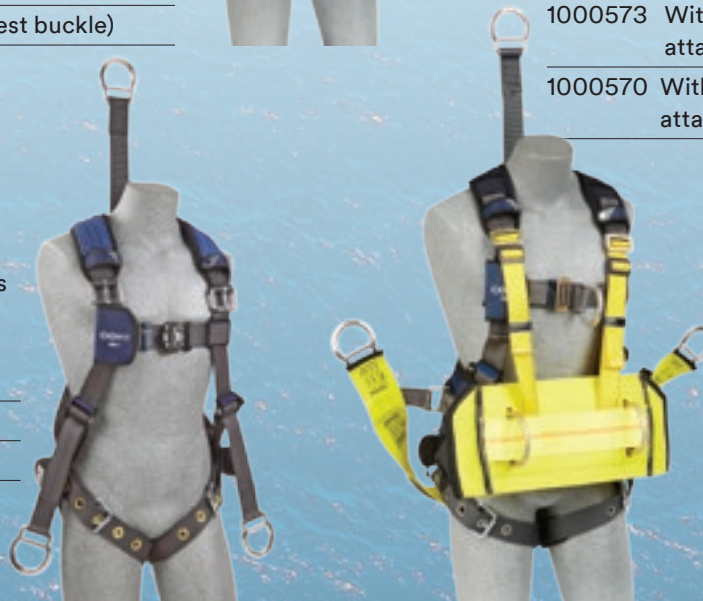

3M™ DBI-SALA® ExoFit NEX™

Rope Access & Rescue Harnesses Certified to NFPA 1983

Complex jobs are easier when your equipment is suited to the task. That's why the ExoFit NEX Rope Access & Rescue Harnesses incorporate some of the most advanced technologies in the industry. These multi-use harnesses incorporate specialized designs, components and hardware to optimize rope rescue and industrial rope access work. This makes them ideal for the professional performing rescue and emergency services, industrial rope access and rigging, wind energy and tower maintenance—as well as for arborist activities.

1113348

ExoFit NEX Rope Access & Rescue Harness

REPEL™ Technology Webbing, Tech-Lite™ Aluminum Front, Back and Side D-rings, Duo-Lok™ Quick-Connect Buckles and hybrid comfort padding. (XLarge)

1113345 Small

1113346 Medium

1113347 Large



Back view

1113373

ExoFit NEX Blackout Rope Access & Rescue Harness

REPEL Technology Webbing, Tech-Lite Aluminum Front, Back and Side D-rings, Duo-Lok Quick-Connect Buckles and hybrid comfort padding. (XLarge)

1113370 Small

1113371 Medium

1113372 Large



3M™ DBI-SALA® ExoFit NEX™ Arc Flash Full-Body Harness

The ultimate full-body comfort harness

Complete confidence. It's what you need to get the job done around high voltage electricity or hot-work, like welding. You need gear that's proven and built for the task. That's why the ExoFit NEX Arc Flash Full-Body Harness features flame resistance and non-conductive construction on top of all the comfort, function and durability features of the original ExoFit NEX Full-Body Harness. It meets arc flash standard specifications for personal climbing equipment as well as ANSI Z359 and CSA requirements.

1 Flame-resistant webbing

Nomex® fiber exterior with Kevlar® fiber core and thread provides 7,000 lb. strength and ultimate flame resistance.

2 Revolver™ Vertical Torso Adjusters

Simple and fast adjustments that eliminate loose ends and lock into place, preventing slippage.

3 PVC Coated Tech-Lite™ Aluminum D-rings

Non-conductive, extremely lightweight aluminum alloy hardware offers the highest level of comfort and security.

4 Flame-resistant trauma straps

Provide an adjustable, continuous loop for post fall, minimizing suspension trauma.

5 Integrated insulators

Leather insulators behind exposed hardware prevent contact with body during "hot" situations.

6 Ultra-soft edging

Moves with you. Doesn't rub or chafe.

Arc flash rated

Tested to perform in accordance with ASTM F887 standard for personal climbing equipment.



**420 lb.
Capacity**

On all models

7 Arc flash hybrid padding

Lightweight shoulder, hip and leg padding always keeps the wearer comfortable.

8 Molded lanyard keepers

Easy holstered lanyard hooks break away to avoid trip hazard.

9 Reflective material

Integrated on legs, chest, shoulders and back for greater visibility and safety.

10 Built-in carrying pocket

Conveniently holds a cell phone, camera or other items.

11 Duo-Lok™ Quick-Connect Buckles

Lightweight aluminum, one-handed use with memory fit web lock ensures fast, non-slipping connections.

12 Stand-up dorsal D-ring

Non-conductive, extremely lightweight PVC-coated aluminum D-ring is spring loaded for fast and easy connections.

Also available in web loop configurations.

*Model shown
1113318*



Superior X-design

Wrap-around design provides the ultimate in comfort, security and no-tangle donning.

3M™ DBI-SALA® ExoFit NEX™ Arc Flash

Vest-Style Full-Body Harnesses

1103088

ExoFit NEX Arc Flash Harness

With Nomex®/Kevlar® fiber web, PVC coated aluminum back D-ring, locking quick-connect buckles, comfort padding. (XLarge)

1103085 Small

1103086 Medium

1103087 Large



1113338

ExoFit NEX Arc Flash Harness

With Nomex/Kevlar fiber web, PVC coated aluminum back D-ring, coated pass-through buckles, comfort padding. (XLarge)

1113335 Small

1113336 Medium

1113337 Large



1103073

ExoFit NEX Arc Flash Positioning Harness

With Nomex/Kevlar fiber web, PVC coated aluminum back and side D-rings, locking quick-connect buckles, comfort padding. (XLarge)

1103070 Small

1103071 Medium

1103072 Large



1113328

ExoFit NEX Arc Flash Rescue Harness

With Nomex/Kevlar fiber web, dorsal web loop and front rescue loops, locking quick-connect buckles, comfort padding. (XLarge)

1113325 Small

1113326 Medium

1113327 Large



1113333

ExoFit NEX Arc Flash Climbing Harness

With Nomex/Kevlar fiber web, PVC coated aluminum front, back and side D-rings, locking quick-connect buckles, comfort padding. (XLarge)

1113330 Small

1113331 Medium

1113332 Large



1113493

ExoFit NEX Arc Flash Construction Harness

With Nomex/Kevlar fiber web, PVC coated aluminum back, front, and side D-rings, locking quick connect buckles, locking quick connect belt, sewn-in hip pad and belt, comfort pad. (XLarge)

1113490 Small

1113492 Medium

1113491 Large



ExoFit NEX Arc Flash

Construction-Style Harnesses

With integrated hip pad and body belt, these harnesses have excellent tool-carrying capabilities, allow work positioning and provide added back support.



1113318

ExoFit NEX Arc Flash Construction Harness

With Nomex/Kevlar fiber web, PVC coated aluminum back and side D-rings, locking quick-connect buckles, sewn-in hip pad and belt, comfort padding. (XLarge)

1113315 Small

1113316 Medium

1113317 Large



1113369

ExoFit NEX Tower Climbing AFK Harness

With Nomex/Kevlar fiber web, back web loop, PVC coated aluminum front and side D-rings, locking quick-connect buckles, and with Nomex/Kevlar fiber back and leg pads, leather insulators, seat sling. (XLarge)

1113357 Small

1113358 Medium

1113368 Large

Lineman Belts and Harnesses



3M™ DBI-SALA® 4D Seat-Belt™

Designed by linemen, for linemen.

Patent pending design keeps the center of gravity at the top of the belt for improved safety.

1 Durability and comfort

Rolled edge adds durability and comfort at the hips.

2 Hassle-free

S-shaped large full floating D-rings, for hassle-free connection.

3 Cynch-Lok™ compatible

Small D-rings designed for Cynch-Lok Fall Restrict Device.

4 Improved comfort

Patent pending design distributes weight throughout the contoured, reinforced seat for improved work comfort.

5 Easy adjustments

Grommet tongue buckle belt provides easy adjustments and improved durability.



D Size		Belt Sizing					
		Minimum		Center Hole		Maximum	
in.	cm	in.	cm	in.	cm	in.	cm
D18	46	32	81	36	91	40	102
D19	48	33	84	37	94	41	104
D20	51	34	86	38	97	42	107
D21	53	36	91	40	102	44	112
D22	56	37	94	41	104	45	114
D23	58	38	97	42	107	46	117
D24	61	40	102	44	112	48	122
D25	64	41	104	45	114	49	124
D26	66	42	107	46	117	50	127
D27	69	44	112	48	122	52	132
D28	71	45	114	49	124	53	135
D29	74	46	117	50	127	54	137
D30	76	47	119	51	130	55	140



Where to measure to determine the correct "D" size for a Lineman's Belt:

X = Distance from waist or top of hip bone to where Lineman's Belt is worn.

Y = Measurement is from front of hip bone around the back to the front of the other hip bone. This measurement is the "D" size.

1001397 (D23)
3M™ DBI-SALA® 4D Seat-Belt™

Free to move and easy to use. This ergonomic belt features a patent pending design that redirects weight above the waist to reduce the possibility for inversion and to maximize comfort. It's made from 100% top grain leather from Red Wing, MN. The smaller D-rings are designed for a Cynch-Lok™ Fall Restrict Device.



Available in size D18 – D30.

1001392 D18	1001395 D21	1001399 D25	1001402 D28
1001393 D19	1001396 D22	1001400 D26	1001403 D29
1001394 D20	1001398 D24	1001401 D27	1001404 D30

1001384 (D23)
2D Lineman Belt

Make adjustments easier without durability concerns. This belt features a grommet tongue buckle and is made with 100% top grain leather from Red Wing, MN.



Available in size D18 – D30.

1001379 D18	1001383 D22	1001388 D27
1001380 D19	1001385 D24	1001389 D28
1001381 D20	1001386 D25	1001390 D29
1001382 D21	1001387 D26	1001391 D30

ExoFit NEX™ Arc Flash Harness with 2D Belt				
Small	1113675 – D20	1113676 – D21	1113677 – D22	1113678 – D23
Medium	1113681 – D22	1113682 – D23	1113683 – D24	1113684 – D25
Large	1113688 – D25	1113689 – D26	1113690 – D27	–
XLarge	1113691 – D25	1113692 – D26	1113693 – D27	–

Full-Body Arc Flash Harnesses

1113764
ExoFit NEX Rope Access/Rescue Harness - Arc Flash

No-step through configuration, PVC coated aluminum front, suspension, back, and side D-rings, locking quick-connect buckles, Nylon/Kevlar® fiber web, Kevlar® fiber hybrid padding, leather insulators. (Size XLarge)

1113761 Small

1113762 Medium

1113763 Large



1113786
ExoFit NEX Rope Access/Rescue Harness - Arc Flash

PVC coated aluminum front, suspension, and back D-rings, locking quick-connect buckles, Nylon/Kevlar® fiber web, Kevlar® fiber hybrid padding, leather insulators (size XLarge), with 100% top grain leather 2D Lineman Belt. (Size D26)

1113768 Small D21

1113774 Medium D23

1113781 Large D25



1113760
ExoFit NEX Rope Access/Rescue Harness - Arc Flash

PVC coated aluminum front, suspension, back, and side D-rings, locking quick-connect buckles, Nylon/Kevlar® fiber web, Kevlar® fiber hybrid padding, leather insulators. (Size XLarge)

1113757 Small

1113758 Medium

1113759 Large



1113692
ExoFit NEX Lineman Arc Flash Harness with 2D Belt

PVC coated steel back D-ring, locking quick-connect buckle leg straps, Nomex®/Kevlar® fiber webbing and comfort padding (size XLarge) with 100% top grain leather 2D Lineman Belt. (Size D26)

1113676 Small D21

1113682 Medium D23

1113688 Large D25



Sizing in combination of harness & "D" size

3M™ DBI-SALA® ExoFit™ Full-Body Harness

The industry's first
comfort harness

ExoFit is the design that
changed what workers
expect from a harness.

Comfort. It's the one word that best defines the 3M DBI-SALA ExoFit, our original comfort fit harness. It features a single piece of material that wraps around you in the shape of an X, donning without tangling and providing comfortable security. ExoFit even remembers your adjustments, so you can snap three buckles and get to work. Shoulder, hip and leg padding is built-in, so it can't slip. A breathable lining guarantees you'll stay dry and comfortable all day long.

**420 lb.
Capacity**

1 Ultra-soft edging

Moves with you without rubbing or chafing.

2 Torso buckles

Hold straps firmly in place, adjust easily and complete the 5-point adjustment system.

3 Cushioned leg and hip straps

Comfortable and offer additional security during a fall.

4 Quick-connect buckles

Provide one-handed operation for fast, easy donning.

5 Cushioned shoulder pads

Help minimize pressure on shoulders. Designed so they won't slip or slide off your shoulder.

6 Breathable lining

Immediately draws moisture away, keeping you dry and comfortable.

7 Easy-grip end tabs

Something secure to hang on to when adjusting the straps.

8 Anti-tear ballistic nylon

Abrasion-resistant for rugged strength and durability. Twice the endurance of standard nylon or polyester.

9 Reflective piping

Enhances visibility in low light conditions.

10 Back D-ring

Keeps you upright every time. 5,000 lb. minimum tensile strength.



Model shown
1107981

3M™ DBI-SALA® ExoFit™

Vest-Style Harnesses

Vest-style harnesses are the most universal, with multiple configurations and connection point options. They're used across a wide variety of industries.



1107981

ExoFit Vest-Style Harness

Back D-ring, loops for belt, quick-connect buckles. (XLarge)

1107975 Small

1107976 Medium

1107977 Large



1108532

ExoFit Vest-Style Harness

Front and back D-rings, loops for belt, quick-connect buckles. (XLarge)

1108525 Small

1108526 Medium

1108527 Large



1108581

ExoFit Vest-Style Harness

Back and side D-rings, loops for belt, quick-connect buckles. (XLarge)

1108575 Small

1108576 Medium

1108577 Large



1108606

ExoFit Vest-Style Harness

Front, back and side D-rings, loops for belt, quick-connect buckles. (XLarge)

1108600 Small

1108601 Medium

1108602 Large



1109358

ExoFit Vest-Style Harness

Back D-ring, loops for belt, tongue buckle legs. (XLarge)

(XLarge)

1109356 Small

1109355 Medium

1109357 Large

ExoFit

Crossover-Style Harnesses

A front-mounted D-ring makes the crossover-style ideal for ladder climbing and rescue applications.



1108682

ExoFit Crossover-Style Harness

Front and back D-rings, loops for belt, quick-connect buckles. (XLarge)

1108675 Small

1108676 Medium

1108677 Large



1108706

ExoFit Crossover-Style Harness

Front, back and side D-rings, loops for belt, quick-connect buckles. (XLarge)

1108700 Small

1108701 Medium

1108702 Large

Full-Body Harnesses

3M™ DBI-SALA® ExoFit™

Construction-Style Harnesses

Made for general construction work, these harnesses have excellent tool-carrying capability, a sewn-in hip pad and removable body belt.

1108507

ExoFit Construction-Style Harness

Back D-ring, sewn-in back pad and belt with side D-rings, quick-connect buckles. (XLarge)

1108500 Small

1108501 Medium

1108502 Large



1110478

ExoFit Construction-Style Harness

Back D-rings, sewn-in hip pad and belt with side D-rings, tongue buckle legs. (XLarge)

1110475 Small

1110476 Medium

1110477 Large



1108979

ExoFit Construction-Style Harness

Back and front D-ring, sewn-in back pad and belt with side D-rings, quick-connect buckles. (XLarge)

1108977 Small

1108978 Medium

1108975 Large

1108519

ExoFit Construction-Style Harness

Back D-ring, sewn-in back pad and belt with side D-rings, quick-connect buckles. (XLarge)

1108516 Small

1108517 Medium

1108518 Large

ExoFit

Derrick Harnesses

Onshore or off, many of the hazards oilrig workers face every day are uniquely challenging. That's why we design ExoFit Derrick Harnesses specifically to maximize comfort and ease of donning for workers who operate the monkey and tubing boards. These models include connections for an optional derrick belt, which enhances comfort while positioning for the next drilling pipe.

1100303

ExoFit Derrick Harness

Vest-style, back D-ring with 18 in. extension, belt with back pad and back D-ring, soft seat sling with positioning D-rings, pass-through buckle connections at shoulder for 1000570 Derrick Belt. (XLarge)

1100300 Small

1100301 Medium

1100302 Large



Back view

Harness at right pictured with 1000570 Derrick Belt

1000570

ExoFit Derrick Belt

Positioning D-rings, pass-through buckles for harness connection. (Universal Size)

3M™ DBI-SALA® ExoFit™

Wind Energy Harnesses

People around the world rely on our wind industry harnesses because they meet the major global compliance standards including ANSI, OSHA, CSA and CE.



Reinforced lumbar area for added back support. Tool loops allow you to keep your tools close at hand.



Integrated trauma straps minimize suspension trauma after a fall.



Full-Body Harnesses

Extra tough tubular web encases sub-pelvic webbing for added wear resistance for straddling beams.



1102388 ExoFit Wind Energy Harness

Quick-connect buckle legs, PVC coated front, back and side D-rings, sewn-in hip pad and belt with tool loops. (XLarge)

1102385 Small

1102386 Medium

1102387 Large



1102343 ExoFit Wind Energy Harness

Quick-connect buckle legs, PVC coated front, back and side D-rings. (XLarge)

1102340 Small

1102341 Medium

1102342 Large



1108657 ExoFit Tower Climbing Harness

Front and back D-rings, belt with back pad and side D-rings, removable seat sling with positioning D-rings, quick-connect buckles. (XLarge)

1108650 Small

1108651 Medium

1108652 Large



1100533 ExoFit Iron Worker's Harness

Back D-ring, sewn-in back pad and belt with side D-rings, reinforced seat straps, tongue buckle legs. (XLarge)

1100530 Small

1100531 Medium

1100532 Large

3M™ DBI-SALA® Delta™ Comfort Full-Body Harness

Delta Comfort Full-Body Harnesses combine a set of “industry-first” advancements with popular features, making them the workhorse of the industry. They feature shoulder, back and leg padding, coated, corrosion-resistant hardware, and abrasion-resistant webbing, resulting in a build quality that is second to none. The padding wraps around you and incorporates vent windows, allowing direct air contact and better circulation to cool the body.

1 Equipped with RFID

2 Revolver™ Vertical Torso Adjuster

Simple and fast adjustment that eliminates loose ends and locks into place, preventing slippage.

3 Vent windows

Padding with built-in vent windows to allow for direct air contact, cooling the worker.

4 Sewn-in dorsal pad

Holds personal SRLs and locks the pad in place to eliminate slippage.

5 Impact indicators

Provides visual alert that the harness has been involved in a fall and simplifies safety inspections.

6 Rigid belt

Allows for 60 lbs. of tools without collapsing.

7 Tongue buckle legs

For fast and easy adjustments (also available with Tech-Lite™ Quick-Connect Buckles).





1100639

3M™ DBI-SALA® Delta™ Comfort Vest-Style Climbing Harness

Back and front D-rings, quick-connect buckle leg and chest straps, comfort padding (XLarge).

1100636 Small

1100637 Medium

1100638 Large



1100748

Delta Comfort Vest-Style Harness

Back D-ring, tongue buckle leg straps, comfort padding (XLarge).

1100745 Small

1100746 Medium

1100747 Large



1100798

Delta Comfort Construction- Style Positioning Harness

Back and side D-rings, belt with pad, tongue buckle leg straps, comfort padding (XLarge).

1100795 Small

1100796 Medium

1100797 Large



1100824

Delta Comfort Vest-Style Positioning Harness

Back and side D-rings, quick-connect buckle leg and chest straps, comfort padding (XLarge).

1100821 Small

1100822 Medium

1100823 Large



1100523

Delta Comfort Construction- Style Positioning/Climbing Harness

Back, front and side D-rings, belt with pad, quick-connect buckle leg and chest straps, comfort padding (XLarge).

1100517 Small

1100518 Medium

1100519 Large



1100788

Delta Comfort Construction- Style Positioning Harness

Back and side D-rings, belt with pad, quick-connect buckle leg and chest straps, comfort padding (XLarge).

1100785 Small

1100786 Medium

1100787 Large



1100938

Delta Comfort Vest-Style Harness

Back D-ring, quick-connect buckle leg and chest straps, comfort padding (size XLarge).

1100935 Small

1100936 Medium

1100937 Large



1100948

Delta Comfort Scaffolding Harness

Back D-ring, quick-connect buckle leg and chest straps, comfort padding (size XLarge).

1100945 Small

1100946 Medium

1100947 Large

3M™ DBI-SALA® Delta™ Full-Body Harness

Innovative, full-body support for more than two decades.

Toughness. Versatility. These are qualities expected of you, so you should expect nothing less from your safety harness. Delta Harnesses combine a number of industry-first innovations with popular features that have made it an industry workhorse that's as tough as those who wear them.

Delta Harnesses have a shape of their own, so you can don them quickly and easily. And they support your back and hips while bearing heavy loads to maximize your comfort.

1 Tangle-free design

Defining the Delta name, the patented triangular design creates a frame that allows the harness to fall into place when donned.

2 Delta Comfort Hip Pad

Improved ergonomic fit constructed with a soft, breathable, comfortable interior that supports your back and hips.

3 Tech-Lite™ Quick-Connect Buckles

Lightweight aluminum alloy buckles for fast and easy connections.

4 Impact indicator

Provides a visual alert that the harness has been involved in a fall and simplifies safety inspections.



5 REPEL™ Technology Webbing

Water repellent to reduce attraction of mold and dirt—also has more abrasion resistance.

6 Lanyard keepers

Hold your unused snap hooks and help reduce trip hazards.

7 Revolver™ Vertical Torso Adjuster

Simple and fast adjustment that eliminates loose ends and locks into place, preventing slippage.

8 Stand-up dorsal D-ring

Patented spring-loaded design automatically stands-up, ensuring fast, easy and safe connections to your fall arrest system.



3M™ DBI-SALA® Delta™

Vest-Style Harnesses

Vest-style harnesses are the most universal, with multiple configurations and connection point options. They're used across a wide variety of industries.



1101781

Delta Vest-Style Harness

Back and shoulder D-rings, pass-through buckles. (Universal Size)

1101254 Tongue Buckles

110602 Quick-Connect Buckles

1101781 Pass-Through Buckles (pictured)



1102000

Delta Vest-Style Harness

Back D-ring, tongue buckle leg straps. (Universal Size)

1102000 Tongue Buckles (pictured)

110600 Quick-Connect Buckles

1103321 Pass-Through Buckles



1102008

Delta Vest-Style Harness

Side and back D-ring, tongue buckle leg straps. (Universal Size)

1102008 Tongue Buckles (pictured)

110625 Quick-Connect Buckles

1103875 Pass-Through Buckles



1102090

Delta Vest-Style Harness

Back and front D-rings, quick-connect buckles. (Universal Size)

1107807 Tongue Buckles

1102090 Quick-Connect Buckles (pictured)

1112126 Pass-Through Buckles



1102001

Delta Vest-Style Harness

Back D-rings, parachute adjuster leg straps. (Universal size)

1104725

Delta Vest-Style Harness

Back D-ring, with belt loops, non-conduct/sparking hardware, pass-through buckle leg straps. (Universal size)

Full-Body Harnesses

3M™ DBI-SALA® Delta™

Construction-Style Harnesses

Made for general construction work, these harnesses have excellent tool-carrying capability, a sewn-in hip pad and removable body belt.

1110578

Delta Construction-Style Harness

Back and side D-rings, quick-connect buckle legs and chest strap, belt with sewn-in back pad. (XLarge)

1110575 Small

1110576 Medium

1110577 Large



1101656

Delta Construction-Style Harness

Vest-style, back and side D-rings, belt with sewn-in back and shoulder pads, tongue buckle leg straps. (XLarge)

1102201 Small

1101654 Medium

1101655 Large



1107809

Delta Construction-Style Harness

Front, back and side D-rings, belt and hip pad, tongue buckle leg. (XLarge)

1107805 Small

1107802 Medium

1107801 Large

1103512

Delta Construction-Style Harness

Back and side D-rings, pass-through buckles, loop for belt. (Universal Size)

1103513

Delta Construction-Style Harness

Back D-ring, pass-through buckles, loops for belt. (Universal Size)

1103525

Delta Construction-Style Harness

Back and side D-rings, tongue buckle legs, loops for belt. (Universal Size)

1103526

Delta Construction-Style Harness

Back D-ring, tongue buckle legs, loops for belt. (Universal Size)

3M™ DBI-SALA® Delta™

Crossover-Style Harnesses

A front-mounted D-ring makes the crossover-style ideal for ladder climbing and rescue applications.

1102950

Delta Crossover-Style Harness

Back and front D-rings, tongue buckles legs. (Universal Size)

1102950 Tongue Buckles (pictured)

110700 Quick-Connect Buckles

1102010 Pass-Through Buckles

1110725

Delta Crossover-Style Harness

Back, front and side D-rings, quick-connect buckles. (Universal Size)

1103375 Tongue Buckles

1110725 Quick-Connect Buckles (pictured)

1103270 Pass-Through Buckles

1101812

Delta Crossover-Style Harness

Front and back D-rings, pass-through legs, belt and hip pad with side D-rings. (XLarge)

1101809 Small

1101810 Medium

1101811 Large



Full-Body Harnesses

1106452

3M™ DBI-SALA® Delta™ Iron Worker's Harness

Vest-style, back D-ring, adjustable belt support straps with clips, body belt with permanently attached pad, shoulder pads, accessory clips, wear layer web on seat sling, pass-through leg straps. (XLarge)

1106453 Small

1106451 Medium

1106450 Large



Back view

1106408

Delta Iron Worker's Harness

Vest-style, back D-ring adjustable belt support straps with clips, body belt with permanently attached pad, shoulder pads, accessory clips, wear layer web on seat sling, tongue buckle leg straps. (XLarge)

1106403 Small

1106404 Medium

1106405 Large

1107778

Delta Tower Climbing Harness

Vest-style, front and back D-ring, belt with 4 in. wide pad and side D-rings, two tool pouch D-rings, seat sling with positioning D-rings, tongue buckle legs. (XLarge)

1107776 Small

1107777 Medium

1107775 Large



1103352

Delta Tower Climbing Harness

Crossover-style, front D-ring, belt with 4 in. wide pad and side D-rings, two tool pouch D-rings, seat sling with positioning D-rings, tongue buckle legs. (XLarge)

1103355 Small

1103351 Medium

1103350 Large

Delta

Arc Flash Harnesses

When high voltage electricity is a concern, your safety harness absolutely shouldn't be. That's why every 3M DBI-SALA Delta Arc Flash Harness has been tested to perform in accordance with the stringent ASTM F887 Standard Specification for Personal Climbing Equipment.



1110752

Delta Arc Flash Harness

7,000 lb. nylon web, no metal above the waist, front and back web loop, pass-through buckle legs, leather insulators. (XLarge)

1110754 Small

1110750 Medium

1110751 Large



1110782

Delta Arc Flash Harness

7,000 lb. nylon web, back web loop, quick-connect buckles, leather insulators, rescue loops. (XLarge)

1110788 Small

1110780 Medium

1110781 Large



1100784

Delta™ Arc Flash Harness

7,000 lb. nylon web, quick-connect chest buckle, tongue buckle leg straps, leather insulators, rescue loops. (XLarge)

1110773 Small

1110774 Medium

1110783 Large



1110830

Delta Arc Flash Harness

With Nomex®/Kevlar® fiber web, PVC coated hardware, back D-ring, pass-through leg straps. (Universal Size)



1110820

Delta Arc Flash Harness

With Nomex/Kevlar fiber web, vest-style, back web loop, quick-connect buckles. (Universal Size)



1110940

Delta Arc Flash Harness

With Nomex/Kevlar fiber web, cross-over style, PVC coated hardware, front, back and side D-rings. (Universal Size)

1150058

Delta Arc Flash Kit

Includes 1110752 Delta Arc Flash Nylon Harness with web loop and Arc Flash Shock-Absorbing Lanyard, 6 ft. (1246305), with bag. (XLarge)

1150054 Kit with Large harness (1110752)



3M™ DBI-SALA® Delta Vest™

Hi-Vis Reflective and Non-Reflective Workvest Harnesses

Safety is a top priority any time of day. That's why our sleeveless waist-length vests feature a built-in harness for high visibility while working at-height, day or night. They meet ANSI class II requirements for high visibility vests.

1111580

Delta Vest Hi-Vis Reflective Harness

Orange workvest-style harness, reflective, back D-ring, quick-connect legs. (Universal Size)



1111584

Delta Vest Hi-Vis Reflective Harness

Yellow workvest-style harness, reflective, back D-ring, quick-connect legs. (Universal Size)



1111576

Delta Vest

Cotton blue workvest-style harness, non-reflective, back D-ring, quick-connect legs. (Universal Size)



1107404

Delta Vest Hi-Vis Reflective Harness

High visibility orange workvest-style harness, reflective, back D-ring, tongue buckle legs. (Universal Size)

1107420

Delta Vest Hi-Vis Reflective Harness

High visibility yellow workvest-style harness, reflective, back D-ring, tongue buckle legs. (Universal Size)

1107416

Delta Vest Hi-Vis Non-Reflective Harness

Blue cotton workvest-style harness, non-reflective, back D-ring, tongue buckle legs. (Universal Size)

Delta

Harnesses for Hot Work Use

Stay safe even when things heat up. Featuring heat-resistant and flame-retardant Nomex®/Kevlar® fiber webbing, these harnesses have a 700° Fahrenheit char temperature.

1105475

Delta Harness for Hot Work Use

Vest-style, with Nomex/Kevlar fiber web, back D-ring, with non-conductive/spark hardware, pass-through buckle leg straps, loops for belt. (Universal Size)



1104775

Delta Harness for Hot Work Use

Crossover-style, front, back and side D-rings, with Nomex/Kevlar fiber web, pass-through buckle leg straps, loops for belt. (Universal Size)

1104625

Delta Harness for Hot Work Use

Vest-style, back D-ring, with Nomex/Kevlar fiber web, pass-through buckle leg straps, loops for belt. (Universal Size)

Delta Resist

Webbing Harnesses

Protect against grease, oil, dirt and grime with integrated Resist Technology (polyurethane coated webbing).

1110990

Delta Resist Webbing Harness

Vest-style, back D-ring, tongue buckle legs. (Universal Size)



1109975

Delta Harness for Hot Work Use

Vest-style, back D-ring, with Nomex/Kevlar fiber web, quick-connect buckles, loops for belt. (Universal Size)

Full-Body Harnesses

3M™ DBI-SALA® Delta Vest™

Oil and Derrick Harnesses

More comfort and security. Less hassle. These harnesses are designed specifically for easy donning and use by workers who operate the monkey and tubing boards on oil rigs. They also include connections for an optional derrick belt, which adds comfort while positioning for the next drilling pipe.

1105828

Delta Derrick Harness

Back, side D-rings, tongue buckle legs, use with 1000545 Derrick Belt. (XLarge)

1105826 Small

1105827 Medium

1105825 Large



1000545

Derrick Belt

Work positioning rings, pass-through buckle connection. (XLarge)

1000542 Small

1000543 Medium

1000544 Large

1108128

Delta Bosun Chair Harness

Front and back D-ring with 18 in. dorsal D-ring extension, tongue buckle belt/ pad and side D-rings, seat sling with rigid seat board. (XLarge)

1108126 Small

1108127 Medium

1108125 Large



Built-in seat board for added support.

1106107

Delta™ Derrick Harness

18 in. dorsal D-ring extension, belt and hip pad with back D-ring, seat sling, tongue buckle legs, pass-through connection to Derrick Belt (1000570). (XLarge)

1106112 Small

1106108 Medium

1106106 Large



1000570

Derrick Belt

Work positioning rings, pass-through buckle connection.

1106354

Delta Derrick Harness

Back and lifting D-rings, tongue buckle legs and connection to Derrick Belt (1003222). (XLarge)

1106357 Small

1106350 Medium

1106353 Large



1003222

Derrick Belt

Work positioning rings, tongue buckle belt. (XLarge)

1003220 Small/Medium

1003221 Large

Harnesses shown with Derrick Belt.

Belts, Workseats & Accessories

3M™ DBI-SALA®

Workseats

1001190 Bosun Chair

12 in. x 24 in. x 1 in. board, cushion and side snaps.



1001140 Bosun Chair only

12 in. x 24 in. x 1 in. board.



1001005 Work Seat

With board, tongue buckle belt and pad, suspension D-rings, adjustable leg/shoulder strap. (XLarge)

1001001 XSmall

1001002 Small

1001003 Medium

1001004 Large

1001090 Harness Seat Sling

8 in. wide, belt attachment loops and D-rings.

1001378 Suspended Workman's Chair

Polyester webbing, alloy steel connectors, weight capacity of up to 420 lbs.



Lineman Belts



Achieve the maximum in comfort, freedom of movement and ease of use with our ergonomically designed belts.

See pages 28 and 29 for more information.

Tongue Buckle Belts



1000025 Tongue Buckle Belt

Side D-rings, 3 in. pad. (XLarge)

1000022 Small

1000023 Medium

1000024 Large



1000055 Delta™ Tongue Buckle Belt

No D-ring, no pad. (XLarge)

1000052 Small

1000053 Medium

1000054 Large

1000005 Tongue Buckle Belt

back D-ring, 3 in. pad. (XLarge)

1000002 Small

1000003 Medium

1000004 Large

1000165 Tongue Buckle Belt

With floating D-ring, no pad. (XLarge)

1000162 Small

1000163 Medium

1000164 Large

1000717 ExoFit™ Tongue Buckle Belt

No D-ring, no pad. (XLarge)

1000708 Small

1000709 Medium

1000716 Large

Customize your 3M DBI-SALA Harnesses

Promote your company brand by customizing your harnesses with a logo label (minimum order quantity required).

- Same style of harness required, order can be in multiple sizes.
- One logo per harness.
- Logos on Delta Harnesses: Black on clear background, sublimation transferred.
- Logos on ExoFit NEX™ Harnesses: Custom logo and embroidery, multiple colors to choose from.





3M™ DBI-SALA® Suspension Trauma Safety Straps

Relief. It can make a big difference when you're suspended in your safety harness. It's why every worker should be equipped with Suspension Trauma Safety Straps. They easily deploy and hook together in seconds, allowing a suspended worker to stand up in harness with one or both feet to relieve downward pressure. They're compact, lightweight and compatible with most harness brands in the field.



9501403 Suspension Trauma Safety Straps

One pair, connects to most harnesses.



9505712 Flame-Resistant Suspension Trauma Safety Straps

One pair, connects to most harnesses.



9511597 Harness and Lanyard Bag

3M™ DBI-SALA® Bag 7-1/2 in. wide x 6-1/2 in. deep x 15-1/2 in. long, holds a harness and lanyard or 50 ft. of 5/8 in. rope.



9500468 Offshore Life-Jacket

Offshore Orange Life-Vest, back opening for harness, safety whistle, 62 sq. in. of SOLAS (Safety of Life at Sea) grade reflective tape, foam-filled head support collar with two vertical adjustable straps, hinged back panel for comfort. Cat. No: 1600 type 1-US Coast Guard Approved. (Universal size)



5900892 Pouch with Belt Loops

Velcro closure (blue color)



5900891 Pouch with Belt Loops

Clip and Velcro closure (blue color)

9505515 Lumbar Wear Pads

Removable lumbar wear pad for 3M DBI-SALA ExoFit NEX™ Wind Energy Harness Belt. (Large, XLarge, XXLarge)

9505504 Small, Medium



1150037 Dorsal Web Cover

Helps protect dorsal webbing on harness while climbing or descending a ladder such as in wind turbine towers.



1150143 + 1150144 Qty 2 and Qty 50 Attachment Breakaway Lanyard Keeper

Plastic ring with Velcro used to "park" lanyard when not in use.



9502006 Foam Shoulder Pad

Sold one each, two required per harness.



1231117 D-ring Extension

D-ring at one end, snap hook at other x 18 in. (46 cm).



9501207 3M DBI-SALA Delta™ Comfort Pad

Attaches to most harnesses to provide wrap-around comfort.



Fall Protection
for Tools

Everything you need to stop the drop.



The science of fighting gravity.

Protecting workers takes more than just keeping them from falling. Equipment dropped from height can be just as hazardous.

That's why for over 10 years, we've been pioneering an innovative line of products and solutions to prevent dropped tools and equipment. From construction sites to oil rigs, we help make work environments safer and more productive by protecting workers from hazards that can result in personal injury, equipment damage and tool loss.

Certified and tested.

Our onsite ISO 17025 accredited lab allows us to simulate heat, cold, moisture, corrosion and abrasion—the challenges you face every day. We conduct dynamic and static strength tests, both in the field and in our ISO 9001 certified manufacturing facilities, ensuring you get the highest quality, most reliable fall protection for tools.

Watch 3M™ DBI-SALA® Fall Protection for Tools in action: <http://bit.ly/FPFTVideos>.

Fall Protection for Tools

Attachment Points

3M™ DBI-SALA® D-Rings

- D-rings can be attached to virtually any tool under 5 lbs. or 2 lbs. using our Quick-Wrap Tape (see page 49).
- Creates an attachment point in less than a minute.
- Dual D-rings allow for 100% tool tie-off during tool transfers.



Part #	Description	Load rating	Quantity	Non-conductive
1500003	D-ring 0.5 in. x 2.25 in.	2 lbs. (0.9 kg)	10 Pack	No
1500004	D-ring 0.5 in. x 2.25 in.	2 lbs. (0.9 kg)	100 Pack	No
1500005	D-ring 0.5 in. x 2.25 in. non-conductive	2 lbs. (0.9 kg)	10 Pack	Yes
1500006	D-ring 0.5 in. x 2.25 in. non-conductive	2 lbs. (0.9 kg)	100 Pack	No
1500007	D-ring 1 in. x 3.5 in.	5 lbs. (2.3 kg)	10 Pack	No
1500008	D-ring 1 in. x 3.5 in.	5 lbs. (2.3 kg)	50 Pack	No
1500001	Dual D-ring small	2 lbs. (0.9 kg)	10 Pack	No
1500002	Dual D-ring small	2 lbs. (0.9 kg)	100 Pack	No



3M™ DBI-SALA® Quick-Wrap Tape

- Heavy duty 1 in. wide tape conforms to the shape of whatever it is applied to.
- Used with our D-Rings (see page 48) and Tool Cinch Attachments (see page 50) to create instant tethering points on virtually any tool.
- Made from a self-fusing silicone rubber that leaves no adhesive or residue behind.
- Inner fiberglass webbing increases the strength of the tape and makes the tape resistant to sharp objects.

Part #	Description	Quantity	Length
1500044	Quick wrap, yellow	1	108 in. (274 cm)
1500045	Quick wrap, yellow	10	108 in. (274 cm)
1500046	Quick wrap, yellow	240	108 in. (274 cm)
1500035	Quick wrap, blue	1	108 in. (274 cm)
1500036	Quick wrap, blue	10	108 in. (274 cm)
1500037	Quick wrap, blue	240	108 in. (274 cm)
1500038	Quick wrap, blue, 2x length	1	216 in. (548.6 cm)
1500039	Quick wrap, blue, 2x length	10	216 in. (548.6 cm)
1500040	Quick wrap, blue, 2x length	120	216 in. (548.6 cm)



1500035



1500038



1500044



Fall Protection for Tools

3M™ DBI-SALA® Tool Cinch Attachments

- Tool Cinch Attachments feature a cinch design that allows users to quickly secure equipment up to 35 lbs. or 80 lbs.
- Stabilization wings can be used to keep Tool Cinch Attachments in place using our Quick-Wrap Tape (see page 49).

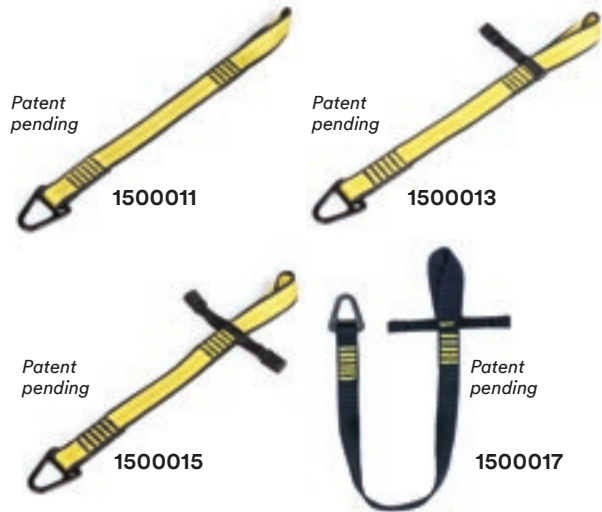

Part #	Description	Load rating	Stabilization wings
1500015	V-Ring attachment point, stabilization wing	35 lbs. (15.9 kg)	2
1500016	V-Ring attachment point, stabilization wing	35 lbs. (15.9 kg)	2
1500013	V-Ring attachment point, stabilization wing	35 lbs. (15.9 kg)	1
1500014	V-Ring attachment point, stabilization wing	35 lbs. (15.9 kg)	1
1500011	V-Ring attachment point, stabilization wing	35 lbs. (15.9 kg)	None
1500012	V-Ring attachment point, stabilization wing	35 lbs. (15.9 kg)	None
1500017	V-Ring attachment point, stabilization wing	80 lbs. (36.3 kg)	2
1500018	V-Ring attachment point, stabilization wing	80 lbs. (36.3 kg)	2

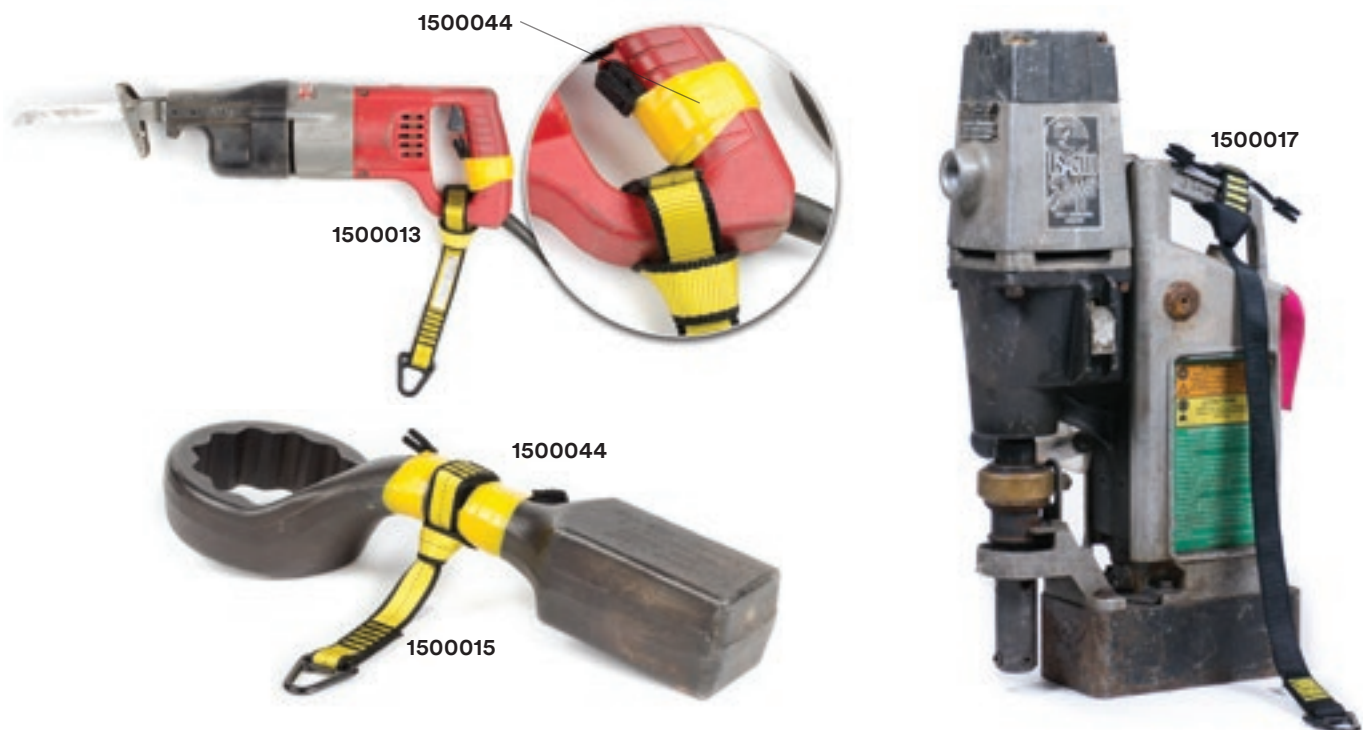

3M™ DBI-SALA®

Heat Shrink

- Protect your investment and connection point!
Heat Shrink protects our Quick-Wrap Tape (see page 49) from abrasives and harsh work environments.
- Heat Shrink links reduce in size by 200% when heat is applied.



Part #	Description	Quantity
1500019	Heat Shrink 0.75 in. x 1.75 in. (1.9 cm x 4.5 cm)	25
1500020	Heat Shrink 1 in. x 1.75 in. (2.5 cm x 4.5 cm)	25
1500021	Heat Shrink 1.5 in. x 2 in. (3.8 cm x 5.1 cm)	25
1500022	Heat Shrink 2 in. x 4 in. (5.1 cm x 10.2 cm)	10
1500023	Heat Shrink 3 in. x 4 in. (7.6 cm x 10.2 cm)	10

D-Ring Cord

1500009

- Easily cinches to tools weighing up to 5 lbs. (2.3 kg).
- Simply pass the loop end of a D-Ring Cord through a pre-drilled hole or closed handle to create an attachment point.
- Extremely durable and reusable.
- Comes in a pack of 10.

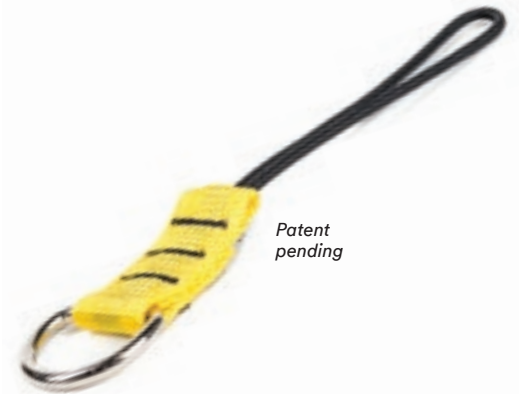

Fall Protection for Tools

3M™ DBI-SALA®

Quick Spins

- Simply slides onto the handle of a tool in seconds.
- Swivel spin top makes them tangle-resistant.
- Reusable and suitable for non-conductive use.
- Comes in packs of 10.

Patented



Part #	Description	Load rating
1500027	Small 0.6 in. (1.5 cm)	1 lbs. (0.5 kg)
1500028	Medium 0.8 in. (2 cm)	1 lbs. (0.5 kg)
1500029	Large 1 in. (2.5 cm)	1 lbs. (0.5 kg)
1500030	X-Large 1.2 in. (3.1 cm)	1 lbs. (0.5 kg)
1500031	Pen Holder 0.3 in. (0.8 cm)	-
1500032	Pen Holder with Coil 0.3 in. (0.8 cm)	-
1500033	Permanent Marker 0.5 in. (1.3 cm)	-
1500034	Permanent Marker with Coil 0.5 in. (1.3 cm)	-



1500028



1500030

Micro D-Ring

1500010

- Designed to allow for easy tethering of small devices such as cell phones, cameras and radios.
- Adheres to most surfaces creating an attachment point in seconds.
- Load rated for 2 lbs. when used with 1500060 (see page 55).
- Uses 3M very high bond adhesive.
- Comes in packs of 10.



3M™ DBI-SALA® Quick Rings

- Quick Rings are an economical solution for tethering tools quickly.
- Allow many tools up to 2 lbs. to be made tether-ready.
- Ring pliers can be used to simplify quick ring installation.
- Comes in packs of 25.

Part #	Description	Load rating
1500024	Quick Ring, Small 0.75 in. (1.9 cm)	2 lbs. (0.9 kg)
1500025	Quick Ring, Medium 1 in. (2.5 cm)	2 lbs. (0.9 kg)
1500026	Quick Ring, Large 1.5 in. (3.8 cm)	2 lbs. (0.9 kg)



Fall Protection for Tools

Tool Lanyards

3M™ DBI-SALA®

Bungee Tethers



1500047



1500049

Part #	Description	Load rating	Length (relaxed)	Length (stretched)
1500047	Hook2Loop Bungee Tether	15 lbs. (4.5 kg)	32 in. (81.3 cm)	47 in. (119.4 cm)
1500048	Hook2Loop Bungee Tether (10 pack)	15 lbs. (4.5 kg)	32 in. (81.3 cm)	47 in. (119.4 cm)
1500049	Medium-Duty Hook2Loop Bungee Tether	35 lbs. (15.9 kg)	31 in. (78.7 cm)	52 in. (132.1 cm)

Engineered to last.

Built to be more durable and longer-lasting than the competition, our bungee tethers are third-party load rated and thoughtfully designed to prevent dropped objects.



Self-Locking carabiner

The Hook2Loop Bungee Tether features a self-locking carabiner that prevents accidental opens and automatically closes.



Competitor non-locking carabiners

Non-locking carabiners can be disconnected with a simple twist, potentially resulting in an accidental drop.

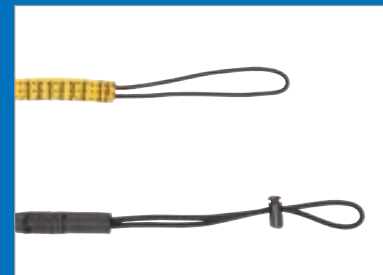

Competitor barrel locks

Many competitive bungee-tether bottoms often utilize a barrel lock. These barrel locks can pose risks as they allow for improper tethering of tools.

3M™ DBI-SALA®

Coil Tethers

An industry-first innovation.

Easy to clean and out of the way—exactly what a tether should be. The lightweight vinyl construction and ultra-compact design of our Coil Tethers makes them an ideal alternative to classic bungee tethers. Since we first introduced them to the marketplace, we've continued to refine and improve our line of coil lanyards with feedback from actual workers in the field.

1500063

Hook2Hook Coil Tether

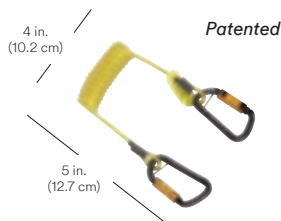

1500067

Trigger2Trigger Coil Tether

- Ideal for use from Wristband.



1500059

Clip2Clip Coil Tether

- Non-conductive
- Ideal for use from Wristband.

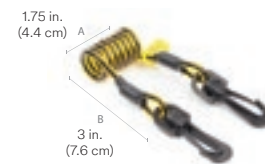

1500065

Hook2QuickRing Coil Tether with Tail

- Use with hammers and other long-handled tools.
- Available as a combo with our Hammer Holster (see page 61).

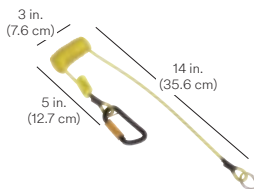

1500060

Clip2Loop Coil Tether

- Secure cameras, cell phones, radios and other small objects.
- Works well with our Micro D-ring (see page 52).

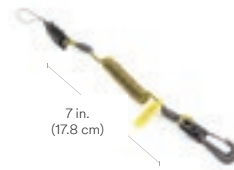

1500061

Hard Hat Tether



Part #	Description	Quantity	Load rating	Length (relaxed)	Length (stretched)
1500063	Hook2Hook Coil Tether	1	5 lbs. (2.3 kg)	4 in. (10.2 cm)	62 in. (157.5 cm)
1500064	Hook2Hook Coil Tether	10	5 lbs. (2.3 kg)	4 in. (10.2 cm)	62 in. (157.5 cm)
1500067	Trigger2Trigger Coil Tether	1	5 lbs. (2.3 kg)	1.75 in. (4.4 cm)	24 in. (70 cm)
1500068	Trigger2Trigger Coil Tether	10	5 lbs. (2.3 kg)	1.75 in. (4.4 cm)	24 in. (70 cm)
1500059	Clip2Clip Coil Tether	10	2 lbs. (0.9 kg)	1.75 in. (4.4 cm)	24 in. (70 cm)
1500065	Hook2Quick Ring Coil Tether with Tail	1	2 lbs. (0.9 kg)	3 in. (7.6 cm)	62 in. (157.5 cm)
1500066	Hook2Quick Ring Coil Tether	10	2 lbs. (0.9 kg)	3 in. (7.6 cm)	62 in. (157.5 cm)
1500060	Clip2Loop Coil Tether	10	2 lbs. (0.9 kg)	7 in. (17.8 cm)	34 in. (86.4 cm)
1500061	Hard Hat tether	10	2 lbs. (0.9 kg)	4 in. (10.2 cm)	34 in. (86.4 cm)
1500062	Hard Hat tether	100	2 lbs. (0.9 kg)	4 in. (10.2 cm)	34 in. (86.4 cm)

Fall Protection for Tools

3M™ DBI-SALA®

Retractor

1500069

- Compatible with a number of our Tool Holsters (see page 59), Wristbands (see page 70), and Tool Pouches (see page 64).
- Inner 52 in. (132 cm) steel coil allows automatic retraction when not in use.
- 1.5 lbs. (0.7 kg) load rating.



Trigger2Trigger Lanyards

- Thumb-controlled trigger snaps on both sides of these lanyards are easy to operate, even while wearing gloves.
- Trigger snaps swivel, making them tangle-resistant.

Part #	Quantity	Load rating	Length
1500053	1	10 lbs. (4.5 kg)	12 in. (30.48 cm)
1500054	10	10 lbs. (4.5 kg)	12 in. (30.48 cm)
1500055	1	10 lbs. (4.5 kg)	24 in. (60.96 cm)
1500056	10	10 lbs. (4.5 kg)	24 in. (60.96 cm)
1500057	1	10 lbs. (4.5 kg)	36 in. (91.44 cm)
1500058	10	10 lbs. (4.5 kg)	36 in. (91.44 cm)



Medium-Duty Hook2Loop Lanyard

1500050

- Features an aluminum double-action twist-lock carabiner to prevent accidental opens.
- Works well with medium-duty tool cinch (see page 50).

Part #	Load rating	Length
1500050	35 lbs. (15.9 kg)	72 in. (182.9 cm)



3M™ DBI-SALA®

Heavy-Duty Hook2Loop Lanyard

1500051

- Features an aluminum double-action twist-lock carabiner to prevent accidental opens.
- Works well with heavy-duty tool cinch (see page 50).

Part #	Load rating	Length
1500051	80 lbs. (36.3 kg)	72 in. (182.9 cm)

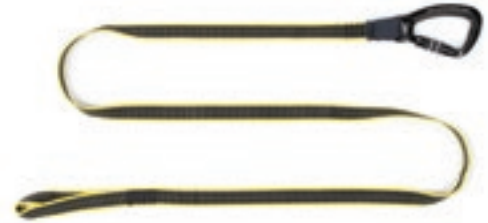

Heavy-Duty Hook2Rail Lanyard

1500052

- Features an aluminum double-action twist-lock carabiner to prevent accidental opens.
- Large double-action twist-lock rail carabiner.
- Works well with heavy-duty tool cinch (see page 50).

Part #	Load rating	Length
1500052	80 lbs. (36.3 kg)	72 in. (182.9 cm)



Fall Protection for Tools

Tool Holsters

3M™ DBI-SALA®

Smart Holsters

Your tools, at the ready.

Safer. Easier. It's not often that your job can be both, but 3M™ DBI-SALA® Smart Holsters are engineered for exactly that. These next generation tool pouches feature intelligent productivity features that are designed to keep your tool right where you want it at all times.

High-Visibility Reflectors

Products equipped with our high-visibility reflectors are always easy to identify and locate, even when left in dark spaces. The highly reflective material stitched into the front and back of the holster makes it easily detectable with a flashlight even in low-light conditions.



The faster, smarter way to holster

Our technology speeds up your workflow and reduces how often your tools need to be holstered. This powerful magnetic tool staging system allows tools to simply stick to the holster, ensuring the tool you need is always at the ready.



Bottom drain vent

You're at your best when your tools are too. The integrated drain vent in our Smart Holsters protects your tools from rusting and your holster from dry rot. Even in rainy weather conditions, the drain vent helps keep the holster dry by allowing water to pass through at all times.



3M™ DBI-SALA®

Single and Dual Tool Holsters



[1] Hook2Loop Bungee Tether sold separately.

- Single and Dual Tool Holsters are equipped with D-rings that are load rated for 5 lbs. (2.3 kg).
- Several variants of these holsters come with Retractors (indicated below) (see page 56). Retractors are load rated for 1.5 lbs. (0.7 kg).
- Single and dual tool holsters feature High-Visibility Reflectors and the Magnetic Tool Staging System.
- A bottom drain vent allows the holster to perform even in wet conditions.

Part #	Description	Retractors included	Attachment
1500103	Single Tool Holster	None	Harness
1500104	Single Tool Holster with Retractor	1x	Harness
1500101	Single Tool Holster	None	Belt
1500102	Single Tool Holster with Retractor	1x	Belt
1500105	Extra-Deep Single Tool Holster	None	Belt
1500108	Dual Tool Holster	None	Harness
1500109	Dual Tool Holster with Retractors	2x	Harness
1500106	Dual Tool Holster	None	Belt
1500107	Dual Tool Holster with Retractors	2x	Belt

Fall Protection for Tools

3M™ DBI-SALA® Tape Measure Holsters

- Designed to be used with virtually any tape measure, or the optional tape measure sleeve, allowing tape measures to be safely tethered and holstered.
- Includes a Retractor (see page 56).
- The tape measure sleeve conforms to the size of nearly every tape measure.
- Features High-Visibility Reflectors.

Part #	Description
1500098	Tape Measure Holster with Retractor
1500099	Tape Measure Sleeve
1500100	Tape Measure Holster with Retractor and Sleeve Combo



Back of holster



1500099 Patent pending

Pouch Holster with Retractor

1500095

- Quickly holster tape measures and other small tools.
- Includes a Retractor (see page 56).



Patent pending

Scaffold Wrench Holster with Retractor

- Quickly holster scaffold wrenches while working at height.
- Features High-Visibility Reflectors.

Part #	Description
1500096	Scaffold Wrench Holster with Retractor
1500097	Scaffold Wrench Holster with Retractor and Hook2Loop Bungee Tether



Patent pending



Back of holster features pouch for Safety Retractor (see page 56). Rear feed system allows retractor to tie off a scaffold wrench while staying out of the way.

3M™ DBI-SALA® Hammer Holster

- The Hammer Holster allows for the safe holstering of virtually any hammer under 5 lbs.
- D-ring on the side of the holster is load rated for 5 lbs. (2.3 kg).
- The 1500094 combo comes with a 1500065 Hook2Quick Ring Coil Tether (see page 55) that is specially designed for use with the Hammer Holster. The Hook2Quick Ring Coil Tether is load rated for 2 lbs. (0.9 kg).
- During transport, the Hammer Holster can be locked shut with a hook and loop strap. While being used, the strap can be locked up allowing for easy hammer access and holstering.

Part #	Description
1500093	Hammer Holster
1500094	Hammer Holster & Hook2Quick Ring Coil Tether



Patent pending

Top: Hammer Holster is locked, preventing hammer from slipping out.

Bottom: Hammer Holster is unlocked, making it suitable for active use.

Adjustable Radio Holster

- Holster adjusts to fit virtually any hand-held radio, cell phone, and many other devices.
- Can be worn from belt or harness.
- A Micro D-Ring (see page 52) can be placed on the back of a device, and can then be tethered to a D-ring on the front of the Adjustable Radio Holster using a 1500065 Clip2Loop Coil Tether (see page 55).

Part #	Description
1500088	Adjustable Radio Holster
1500089	Adjustable Radio Holster, Clip2Loop Coil Tether and Micro D-Ring



Patent pending

1500088

1500060

Can be worn from a belt or harness.

Spray Can/Bottle Holster

- Flexible neoprene holster allows for quick tethering of bottles and spray cans.
- 1500092 comes with 1500059 Clip2Clip Coil Tether (see page 55).

Part #	Description
1500091	Spray Can/Bottle Holster
1500092	Spray Can/Bottle Holster and Clip2Clip Coil Tether



Fall Protection for Tools

3M™ DBI-SALA® Battery Holster/Sleeve

1500090

- Unique sleeve design conforms to the size of virtually any drill battery.
- Sleeve is cinched to the drill, allowing the drill to be tethered off while being used at height.
- 10 lb. (4.5 kg) load rating.



1500049

3M™ DBI-SALA® Comfort Tool Belt

- Extra padding provides superior comfort compared to many other tool belts.
- Modular approach allows user to customize their own holster and pouch system.

Part #	Waist size	Size
1500110	28 in.-36 in. (71 cm-91 cm)	S-M
1500111	36 in.-44 in. (91 cm-112 cm)	L-XL
1500112	44 in.-52 in. (112 cm-132 cm)	2X-3X



Utility Tool Belt

- Padded Cordura provides for durability and comfort.

Part #	Waist size	Size
1500113	28 in.-46 in. (71 cm-117 cm)	S-L
1500114	40 in.-54 in. (102 cm-137 cm)	XL-3X



Belt Loops

- 1500115 is used for tying off tools from a belt, while the 1500117 is used for staging tools.

Part #	Description	Load rating	Quantity
1500115	Belt loop D-ring	5 lbs. (3.2 kg)	1
1500116	Belt loop D-ring	5 lbs. (3.2 kg)	10
1500117	Belt loop trigger	5 lbs. (3.2 kg)	1
1500118	Belt loop trigger	5 lbs. (3.2 kg)	10



Fall Protection for Tools

Tool Pouches

3M™ DBI-SALA®

Small Parts Pouches

Patented



1500123

1500121

1500120

1500122

1500119

- Innovative self-closure system traps objects inside, making it nearly impossible for objects to fall out once placed in the bag.
- Easy to retrieve objects since no opening or closing is necessary.
- Compatible with most tool belts.

Part #	Description
1500123	Small Parts Pouch, extra deep canvas black
1500121	Small Parts Pouch, canvas orange
1500120	Small Parts Pouch, canvas camo
1500122	Small Parts Pouch, vinyl yellow
1500119	Small Parts Pouch, canvas black



Belt loops located on back of pouch.



The Small Parts Pouch is designed for small parts such as nuts, bolts, screws and nails.



Items are placed inside the pouch, at which point they are immediately secured by the self-closure system.



Even when the pouch is flipped vertically, the pouch traps objects inside, making it nearly impossible for them to fall out.

3M™ DBI-SALA® Utility Pouch

- Features two outside pockets for storing spud wrenches and two inner pockets for storing additional tools.
- Tools can be tethered to D-rings on the inside and outside of the pouch.
- Adjustable side-release closure system helps prevent objects from falling out when the pouch isn't being used.



Part #	Product variant
1500132	Utility Pouch
1500130	Utility Pouch with Zipper Closure

Inspection Pouch

1500131

- Designed for the safe transport and use of most multi-meters, air monitors, and other portable testing devices.
- A unique patent pending adjustable opening can be used to create a hands-free workstation off the hip or chest.
- Can be worn off a belt, or over the shoulder using the included shoulder strap.



Hands-free workstation from belt or shoulder.

Patent pending

Tool Pouches

- Constructed from a heavy-duty canvas with an inner lining to help prevent punctures.
- Multiple inner pockets accommodate a number of tools while an integrated D-ring makes tethering tools incredibly easy.
- Available in standard and extra-deep variations.
- The standard pouch uses a hook and loop closure system that can be locked open during use.
- The extra-deep Tool Pouch features a magnetic closure system as well as a side-release buckle.



Part #	Width	Height	Retractors/triggers
1500124	7.5 in. (19.1 cm)	11 in. (27.9 cm)	-
1500125	7.5 in. (19.1 cm)	11 in. (27.9 cm)	2 retractors
1500126	7.5 in. (19.1 cm)	11 in. (27.9 cm)	2 triggers
1500127	8.75 in. (22.2 cm)	13 in. (33 cm)	-
1500128	8.75 in. (22.2 cm)	13 in. (33 cm)	2 reactors
1500129	8.75 in. (22.2 cm)	13 in. (33 cm)	2 triggers

Fall Protection for Tools

Spill Control Buckets

3M™ DBI-SALA®

Safe Buckets

With an integrated closure system that helps prevent dropped objects, our Safe Buckets are designed to be the perfect companion for workers at height carrying heavy loads.

Closure systems

Every Safe Bucket features either a unique, patent-pending drawstring or a locking hook and loop closure system that acts as an extra layer of spill-protection during transport and lifting. Colorful indicator tabs provide quick visual cues to indicate whether the bucket is in lockdown mode or easy-access mode.



Built-in connection points

The Safe Bucket was engineered for use with tools at height, and includes multiple connection points for tethering.

High-quality canvas and vinyl

Safe Buckets are available in both heavy-duty canvas and vinyl variants that are load rated for 100 lbs. and 250 lbs. respectively.



1500134



1500140



3M™ DBI-SALA®

Standard Safe Bucket Models

Integrated carabiner and hoisting strap

Instead of rope, which is susceptible to fraying, a heavy-duty hoisting/shoulder strap is built into every Safe Bucket. Each bucket is also equipped with a high-quality and lightweight aluminum twist-lock carabiner load rated for 30 kN (6,700 lbs.). There is no need to worry about a knot failing, or a non-locking carabiner which may slip off at a connection point.

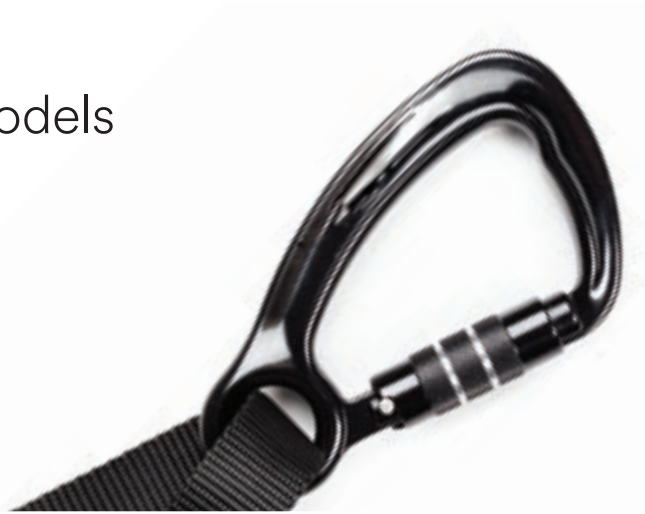

Puncture resistance

Where you work, durability is non-negotiable. That's why every Safe Bucket features hard composite plating at the bottom to protect it from accidental punctures. A leather sleeve also covers the inserts, protecting them from the elements and harsh work environments.



Part #	Load rating	Closure system	Body material	Height/diameter	Capacity
1500134	100 lbs. (45.4 kg)	Hook and loop	Canvas	15 in. / 12.5 in. (38 cm / 31.75 cm)	1840 in. ³
1500133	100 lbs. (45.4 kg)	Drawstring	Canvas	15 in. / 12.5 in. (38 cm / 31.75 cm)	1840 in. ³
1500140	250 lbs. (113.4 kg)	Hook and loop	Vinyl	15 in. / 12.5 in. (38 cm / 31.75 cm)	1840 in. ³
1500139	250 lbs. (113.4 kg)	Drawstring	Vinyl	15 in. / 12.5 in. (38 cm / 31.75 cm)	1840 in. ³

Fall Protection for Tools

3M™ DBI-SALA®

Hard-Body Safe Bucket Insert

1500141

- Converts a standard soft-body Safe Bucket into a hard-body Safe Bucket.
- Our reusable hard-body Safe Bucket insert keeps your Safe Bucket standing upright, making it easier to stage tools and stay productive.
- Integrated inner pockets allow tools to be holstered and organized quickly.



5 Gallon Safe Bucket

1500135

- Used to transport standard 5 gallon buckets.
- 5 gallon plastic buckets clip into the Safe Bucket with a unique hook system.
- When not being used, the Safe Bucket can be flattened for easy storage.
- Unique patent pending locking hook and loop closure system helps ensure that there are no accidental spills during lifting and transportation.
- 100 lb. (45.5 kg) load rating.



Plastic bucket not included.

3M™ DBI-SALA® Long Safe Buckets

- Transport scaffolding and longer tools safely and easily with our Long Safe Buckets.
- More effective than hand-to-hand transportation or using rope with hitch knots.
- Hook and loop top closure system keeps poles secure during lift.
- Equipped with a double twist-action locking carabiner for maximum safety.

Part #	Length	Closure system	Load rating
1500136	48 in. (122 cm)	Hook and loop	100 lbs. (45.4 kg)
1500137	72 in. (183 cm)	Hook and loop	100 lbs. (45.4 kg)
1500138	120 in. (305 cm)	Hook and loop	100 lbs. (45.4 kg)

1500136



Fall Protection for Tools

3M™ DBI-SALA® Pullaway Wristbands

Pullaway wristbands are designed for those who work around rotating or moving equipment. They feature an elastic strap to conform to the wearer's wrist size automatically and come in standard and slim variants.



Pullaway Wristband



Slim Pullaway Wristband



Part #	Description	Qty.	Load rating
1500070	Pullaway Wristband, small	1	5 lbs. (2.3 kg)
1500071	Pullaway Wristband, small	10	5 lbs. (2.3 kg)
1500072	Pullaway Wristband, medium	1	5 lbs. (2.3 kg)
1500073	Pullaway Wristband, medium	10	5 lbs. (2.3 kg)
1500074	Pullaway Wristband, large	1	5 lbs. (2.3 kg)
1500075	Pullaway Wristband, large	10	5 lbs. (2.3 kg)
1500076	Pullaway Wristband, small (slim)	1	5 lbs. (2.3 kg)
1500077	Pullaway Wristband, small (slim)	10	5 lbs. (2.3 kg)
1500078	Pullaway Wristband, medium (slim)	1	5 lbs. (2.3 kg)
1500079	Pullaway Wristband, medium (slim)	10	5 lbs. (2.3 kg)
1500080	Pullaway Wristband, large (slim)	1	5 lbs. (2.3 kg)
1500081	Pullaway Wristband, large (slim)	10	5 lbs. (2.3 kg)

3M™ DBI-SALA® Adjustable Wristbands



Adjustable Wristband

Our adjustable wristband uses a hook and loop system to adjust to any wrist size. An elastic band helps ensure a comfortable fit.



Adjustable Wristband with Cord

Adjusts to any wrist size using a hook and loop system. A built-in cord is used to quickly attach and stage tools directly to the wristband.



Adjustable Wristband with Retractor

Adjusts to any wrist size. A built-in retractor with an attached trigger can be used to quickly work with many hand tools.

Part #	Description	Qty.	Load rating
1500082	Adjustable Wristband	1	5 lbs. (2.3 kg)
1500083	Adjustable Wristband	10	-
1500084	Adjustable Wristband with Cord	1	5 lbs. (2.3 kg)
1500085	Adjustable Wristband with Cord	10	-
1500086	Adjustable Wristband with Retractor	1	1.5 lbs. (0.7 kg)
1500087	Adjustable Wristband with Retractor	10	-



Shock-Absorbing Lanyards

Meeting standards. Then exceeding them.



Shock-Absorbing Lanyards

Quality materials. Built to last.

Trust is earned, not given. So when you trust your life to a 3M™ DBI-SALA® Lanyard, count on this: Every DBI-SALA Lanyard meets or exceeds rigorous industry safety standards, including OSHA and ANSI Z359.13. That's why workers around the world rely on them to be the best in safety, ease-of-use and durability. So next time you climb, trust the best.

Shock-Absorbing Lanyards



Choosing a lanyard

Look for quality in these features when selecting a lanyard.

1 Webbing

Webbing must be strong enough to endure rough use and exposure to sunlight and other elements, without tearing or fraying. Nomex®/Kevlar® with fiber webbing should be used for applications such as welding or arc flash hazards. Webbing may also be coated with polyurethane for protection against grease, oil and grime. Cable lanyards offer extra durability and are ideal if you're working in abrasive or high-heat environments.

2 Impact indicators

Impact indicators let you see if a shock absorber has been involved in a fall. Once an energy absorber has been deployed, the lanyard must be removed from service immediately and destroyed.

3 Connector/hook

Patented 3M™ DBI-SALA® Snap Hooks are popular because they allow one-handed use and won't pinch your thumbs or fingers. Lanyards can also be fitted with larger hooks or carabiners, for connection to larger anchorages.

4 Length

The standard lanyard length is 6 ft. (1.8 m), but both shorter and longer lanyards are available. A lanyard should be long enough to be user-friendly, but kept as short as possible to minimize the free fall distance.

5 Shock absorber

Lanyards used as part of a personal fall arrest system must contain an energy absorbing unit that limits fall arrest forces during a fall to less than 1,800 lbs. (8 kN). Most designs keep forces below 900 lbs. (4 kN) for added safety. Shock absorbers come in pack or tubular styles to meet your preference.

Types of Lanyards



Pack-Style Shock-Absorbing Lanyards

These basic lanyards include a pack-style shock absorber and offer a variety of leg types (web, cable, or with Kevlar® fiber). They dissipate energy, limiting the forces on your body during a fall.



Tubular-Style Shock-Absorbing Lanyards

These lanyards feature an internal shock absorber that dissipates the energy of a fall. This style is available in both a traditional fixed length design and a "stretch" style that expands and contracts.



Twin-Leg Lanyards

Two lanyards that are connected at one end. This style of lanyard is used to provide 100% tie-off, allowing you to stay protected when moving from one location to another.



Positioning Lanyards

Lanyards without shock absorbers, such as rope or web lanyards and chain rebar assemblies, are designed for positioning or restraint applications.

5

Steel and aluminum rebar lock hooks

Patent-pending, locking gate/nose design for maximum strength and security.

Fits around most structures with a 2-1/2 in. gate opening to maximize inner diameter.

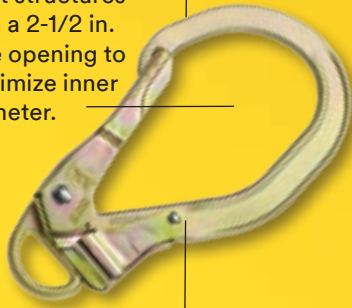

Ergonomic design for enhanced functionality and to better fit in the palm of your hand.

Workers prefer 3M™ DBI-SALA® Snap Hooks



One-handed operation makes our Snap Hooks the most popular in the industry. You can operate them with your gloves on or off, all without your fingers getting in the way!

All our lanyards feature 3,600 lb. (16 kN) rated gates, meeting the rigorous ANSI Z359.12 standard.

Lanyard hook options

Standard Hook

3/4 in. (19 mm) gate opening - 3,600 lb. (16 kN) gate strength.



Aluminum Rebar Hook

2-1/4 in. (57 mm) gate opening - 3,600 lb. (16 kN) gate strength.



Flat Steel Rebar Hook

2-1/2 in. (62.5 mm) gate opening - 3,600 lb. (16 kN) gate strength.



Saflok Max™ Steel Rebar Hook

3 in. (76.2 mm) gate opening - 3,600 lb. (16 kN) gate strength.



Saflok™ Tower Hook

4-5/16 in. (116.84 mm) gate opening - 1600 lb. (16 kN) gate strength.



Aluminum Rebar Lock Hook

2-1/2 in. (63.5 mm) gate opening - 3,600 lb. (16 kN) gate strength.



Steel Rebar Lock Hook

2-1/2 in. (63.5 mm) gate opening - 3,600 lb. (16 kN) gate strength.



2000113 - Saflok Steel Carabiner

1-3/16 in. (30 mm) gate opening - 3,600 lb. (16 kN) gate strength.



2000114 - Saflok Steel Carabiner

2-3/16 in. (55.5 mm) gate opening - 3,600 lb. (16 kN) gate strength.



WrapBax™ Hook

3/4 in. (19 mm) gate opening - 5,000 lb. (22 kN) gate strength.



Tie-Back Carabiner

3/4 in. (19 mm) gate opening - 5,000 lb. (22 kN) gate strength.



Specialty Lanyards



Tie-Back Lanyards

When a qualified anchorage connector is not available, a tie-back lanyard acts as both a connecting means and an anchorage connector, reducing inventory and cost.



Lanyards for Arc Flash and Hot Work Use

Special material with Kevlar® fiber has an 800°F char temperature rating, exceptional cut resistance and is ideal for high temperature environments or those requiring arc flash protection.



Lanyards for Foot Tie-Off

These lanyards can be used at your feet, allowing a 12 ft. (3.7 m) free fall and maintaining forces below 1,800 lbs. (8 kN). Also use for 6 ft. (1.8 m) falls for heavier workers up to 420 lbs. (190 kg).



Fall-Restricting Device

Unique device cinches around a wood pole during a "cut out" preventing user from falling to the ground and allowing user to regain footing.

Shock-Absorbing Lanyards

Shock-Absorbing Lanyards

3M™ DBI-SALA® ShockWave™ 2 Shock-Absorbing Lanyards

Avoid trips and snags on the job with ShockWave2. It's uniquely designed to expand and contract (6 ft.-4-1/2 ft.) in reaction to a worker's movements, and the tubular web stays out of your way when not in use. A built-in impact indicator provides easy visual evidence if the shock has been impact loaded through a fall or improper use. It limits the average fall arresting forces to 900 lbs. (4 kN)



1244306

ShockWave2 Lanyard

Single-leg with snap hooks at each end x 6 ft. (1.8 m)

1244311 ShockWave2 Lanyard

Single-leg with snap hook and aluminum rebar hook x 6 ft. (1.8 m)



1244321 ShockWave2 Lanyard

Single-leg with snap hook and steel rebar hook x 6 ft. (1.8 m)

1244360 ShockWave2 Lanyard

Single-leg with snap hook and Safflok Max Hook x 6 ft. (1.8 m)

1244406 ShockWave2 Lanyard

Twin-leg with snap hooks at each end x 6 ft. (1.8 m)

1244412 ShockWave2 Lanyard

Twin-leg with snap hook and flat steel rebar hooks x 6 ft. (1.8 m)

1244448 ShockWave2 Twin-Leg Lanyard

Twin-leg with snap hook and Safflok™ Max Hooks on leg ends x 6 ft. (1.8 m)



1244409 ShockWave2 Twin-Leg Lanyard

Twin-leg with snap hook and aluminum rebar hooks on leg ends x 6 ft. (1.8 m)



3M™ DBI-SALA® ShockWave™ 2 Rescue Lanyards

These lanyards incorporate an integrated D-ring to help facilitate the rescue of a fallen worker.

1244456 ShockWave2 Rescue Lanyard

Twin-leg with snap hook and steel rebar hooks on leg ends, D-ring for rescue or Self-Retracting Lifeline (SRL) attachment x 6 ft. (1.8 m)



1244750 ShockWave2 Rescue Lanyard

Twin-leg with snap hook and steel rebar hooks on leg ends, integrated rescue D-rings x 6 ft. (1.8 m)



1244455 ShockWave2 Rescue Lanyard

Twin-leg with snap hooks and D-ring for SRL x 6 ft. (1.8 m)

1244459 ShockWave2 Rescue Lanyard

Twin-leg with snap hook and Saflok™ Max Rebar Hooks and D-ring for SRL x 6 ft. (1.8 m)

1244751 ShockWave2 Rescue Lanyard

Twin-leg with snap hook and aluminum rebar hooks on leg ends, integrated rescue D-rings x 6 ft. (1.8 m)

Web Loop Lanyards

Simply choke off to back D-ring or to dorsal web loop. Reduces weight and is ideal for electrical applications where no metal above the waist is preferred.

1244310 ShockWave2 Web Loop Lanyard

Single-leg with snap hook at one end and web loop at the other x 6 ft. (1.8 m)



1244420 ShockWave2 Web Loop Twin-Leg Lanyard

Twin-leg with steel hooks at leg ends x 6 ft. (1.8 m)



Arc Flash Lanyards

Constructed from unique materials, these lanyards have Nomex®/Kevlar® fiber and are ideal for high heat environments or for electrical work when arc flash is a concern. Meets arc requirements of ASTM F887.

1244610 ShockWave2 Arc Flash Lanyard

With Nomex®/Kevlar® fiber single-leg with snap hooks x 6 ft. (1.8 m)



1244611 ShockWave2 Arc Flash Lanyard

With Nomex®/Kevlar® fiber single-leg with snap hook and web loop x 6 ft. (1.8 m)



1244630 ShockWave2 Arc Flash Lanyard

With Nomex®/Kevlar® fiber twin-leg with snap hooks x 6 ft. (1.8 m)



1244631 ShockWave2 Arc Flash Web Loop Twin-Leg Lanyard

With Nomex®/Kevlar® fiber twin-leg with choker and snap hooks on leg ends x 6 ft. (1.8 m)



1244632 ShockWave2 Arc Flash Lanyard

With Nomex®/Kevlar® fiber twin-leg with aluminum hooks at leg ends x 6 ft. (1.8 m)



1244639 ShockWave2 Arc Flash Twin-Leg Lanyard

With Nomex®/Kevlar® fiber twin-leg with aluminum snap hook and Saflok Tower Hooks on leg ends x 6 ft. (1.8 m)



Tie-Back Lanyards

When a qualified anchorage connector is not available, a tie-back lanyard acts as both a connecting means and an anchorage connector.

1244650 ShockWave2 Tie-Back Lanyard

Single-leg with snap hook and 5,000 lb. tie-back carabiner x 6 ft. (1.8 m)



1244675 ShockWave2 Twin-Leg Tie-Back Lanyard

Twin-leg with snap hook and 5,000 lb. tie-back carabiners at leg ends x 6 ft. (1.8 m)



Shock-Absorbing Lanyards

3M™ DBI-SALA® EZ-Stop™

Shock-Absorbing Lanyards

EZ-Stop Lanyards use a controlled tearing action when subjected to fall arrest forces. They limit the average arresting forces to 900 lbs. (4 kN) or less. These lanyards feature 1 in. polyester web construction (unless specified differently), double locking snap hooks, a durable nylon shock absorber cover and various lengths and hook options to fit your job.



1246011

1246011 EZ-Stop Lanyard

Single-leg with snap hooks at each end x 6 ft. (1.8 m)

1246022 EZ-Stop Twin-Leg Lanyard

Twin-leg with snap hooks at each end x 6 ft. (1.8 m)

1246113 EZ-Stop Twin-Leg Lanyard

Twin-leg with snap hook at one end, Saflok™ Max Steel Rebar Hook (3 in. gate opening) at leg ends x 6 ft (1.8 m)

1246181 EZ-Stop Twin-Leg Lanyard

Twin-leg with 7/32 in. vinyl covered cable and snap hooks x 6 ft. (1.8 m)

EZ-Stop Single-Leg Lanyards

EZ-Stop Twin-Leg Lanyards



1246196 EZ-Stop Twin-Leg Lanyard

Twin-leg with elastic leg and snap hooks at each end x 6 ft. (1.8 m)

1246021 EZ-Stop Twin-Leg Lanyard

Twin-leg with snap hook and aluminum rebar hooks at leg ends x 6 ft. (1.8 m)

1246024 EZ-Stop Twin-Leg Lanyard

Twin-leg with snap hook and steel rebar hooks at leg ends x 6 ft. (1.8 m)



1246234 EZ-Stop Adjustable Lanyard

Single-leg, adjustable length with snap hooks x 6 ft. (1.8 m)

1246193 EZ-Stop Lanyard

Twin-leg with elastic legs, aluminum snap hook and aluminum rebar hooks at leg ends x 6 ft. (1.8 m)

1246200 EZ-Stop Lanyard

Elastic leg, 1 in. web, snap hooks at ends, x 6 ft. (1.8 m)

1246188 EZ-Stop Lanyard

7/23 in. vinyl coated cable, snap hook at each end x 6 ft. (1.8 m)



1246103 EZ-Stop Single-Leg Lanyard

Single-leg with snap hook and aluminum rebar hook x 6 ft. (1.8 m)

1246101 EZ-Stop Single-Leg Lanyard

Single-leg with snap hook and Saflok Max Hook x 6 ft. (1.8 m)

1246100 EZ-Stop Single-Leg Lanyard

Single-leg with snap hook and Saflok steel carabiner x 6 ft. (1.8 m)

1246177 EZ-Stop Shock Absorber

Add in-line to a non-shock absorbing lanyard for fall arrest applications. Snap hook at one end, D-ring at other x 19. in. (50 cm)



3M™ DBI-SALA® EZ-Stop™ Modular Lanyards

Reduce the cost of ownership with the industry's first modular lanyard: EZ-Stop Modular Lanyards. It allows components to be replaced individually rather than purchasing an entirely new unit. It's easy to use with a patented, one-handed quick-connect design and unique connectors for maximum versatility.

Components can be changed in the field to accommodate various tasks.

- Leg lengths and materials.
- Single-leg to twin-leg.
- Larger or smaller-sized hooks.

1246040 EZ-Stop Modular Lanyard

Modular web leg connector at one end, aluminum snap hook at other end x 6 ft. (1.8 m)



1246041 EZ-Stop Modular Lanyard

Modular web leg connector at one end, snap hook at other end x 6 ft. (1.8 m)



1246042 EZ-Stop Modular Lanyard

Modular elastic leg, modular connector at one end, snap hook at other end x 6 ft. (1.8 m)



1246043 EZ-Stop Modular Lanyard

Modular elastic leg, modular connector at one end, aluminum snap hook at other end x 6 ft. (1.8 m)

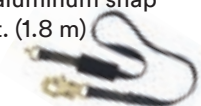

1246044 EZ-Stop Arc Flash Modular Lanyard

With Kevlar® fiber reinforced leg, modular connector at one end, snap hook at other end x 6 ft. (1.8 m)

1246045 EZ-Stop Modular Lanyard

Modular web legs, twin-leg, modular connector at one end, steel rebar hook (2-1/2 in. gate opening) at leg ends x 6 ft. (1.8 m)

1246046 EZ-Stop Modular Lanyard

Modular web legs, twin-leg, modular connector at one end, steel rebar hook (2-1/2 in. gate opening) at leg ends x 6 ft. (1.8 m)

1246047 EZ-Stop Modular Lanyard

Modular elastic legs, twin-leg, modular connector at one end, steel rebar hook (2-1/2 in. gate opening) at leg ends x 6 ft. (1.8 m)



1246048 EZ-Stop Modular Lanyard

Modular elastic legs, twin-leg, modular connector at one end, aluminum rebar hook (2-1/2 in. gate opening) at leg ends x 6 ft. (1.8 m)

1246049 EZ-Stop Arc Flash Modular Lanyard

Modular Kevlar® fiber leg, twin-leg, modular connector at one end, steel rebar hook (2-1/2 in. gate opening) at leg ends x 6 ft. (1.8 m)



1246050 EZ-Stop Modular Lanyard

Modular WrapBax™ Web Leg, modular connector at one end, WrapBax Hook at other end x 6 ft. (1.8 m)



1246060 EZ-Stop Modular Shock Pack

Modular shock absorber, modular connector at one end, aluminum snap hook at other end.

1246061 EZ-Stop Modular Shock Pack

Modular shock absorber, modular connector at one end, snap hook at other end.

EZ-Stop Tie-Back Lanyards

When a qualified anchorage connector is not available, a tie-back lanyard acts as both a connecting means and an anchorage connector.

1246085 EZ-Stop Tie-Back Lanyard

Single-leg with floating D-ring for tie-back, snap hooks at ends x 6 ft. (1.8 m)

1246070 EZ-Stop Tie-Back Lanyard

Twin-leg with floating D-rings for tie-back, snap hooks at ends x 6 ft. (1.8 m)

1246088 EZ-Stop Tie-Back Lanyard

Single-leg with floating D-ring for tie-back, snap hook and aluminum rebar hook x 6 ft. (1.8 m)



1246071 EZ-Stop Tie-Back Lanyard

Twin-leg with floating D-rings for tie-back, snap hook and aluminum rebar hooks at leg ends x 6 ft. (1.8 m)

1246072 EZ-Stop Twin-Leg Tie-Back Lanyard

Twin-leg with floating D-rings for tie-back, snap hook and steel rebar hook at leg ends x 6 ft. (1.8 m)



1246089 EZ-Stop Tie-Back Lanyard

Single-leg with floating D-ring for tie-back, snap hook and steel rebar hook x 6 ft. (1.8 m)

EZ-Stop Resist Lanyards

1246226 EZ-Stop Resist Lanyard

Single-leg polyurethane coated web, snap hooks x 6 ft. (1.8 m)

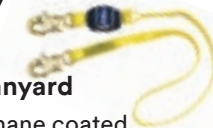

1246203 EZ-Stop Tie-Back Resist Lanyard

Twin-leg polyurethane coated web, floating D-rings for tie-back, snap hooks x 6 ft. (1.8 m)



1246213 EZ-Stop Resist Lanyard

Twin-leg polyurethane coated web, snap hooks x 6 ft. (1.8 m)

Shock-Absorbing Lanyards

3M™ DBI-SALA® EZ-Stop™

Lanyards for Arc Flash and Hot Work Use

Constructed from unique materials, these lanyards are ideal for high heat environments or for electrical work when arc flash is a concern. Meets arc requirements of ASTM F887.

1246306

EZ-Stop Arc Flash Lanyard

Single-leg with Nomex®/Kevlar® fiber web with snap hooks x 6 ft. (1.8 m)

1246307

EZ-Stop Arc Flash Lanyard

Single-leg with Nomex®/Kevlar® fiber webbing, aluminum snap hook and aluminum rebar hook at leg end x 6 ft. (1.8 m)

1246352

EZ-Stop Arc Flash Lanyard

Adjustable web twin-leg Force2™ with Nomex®/Kevlar® fiber webbing and shock pack, aluminum snap hook at center, Safflok™ Tower Hooks at leg ends x 6 ft. (1.8 m)

1246321

EZ-Stop Arc Flash Lanyard

Twin-leg Force2 with adjustable Nomex®/Kevlar® fiber webbing, aluminum snap hook and aluminum rebar hooks at leg ends x 6 ft. (1.8 m)

1246310

EZ-Stop Arc Flash Lanyard

With polyurethane coated web, web loop at one end, snap hook at the other end x 6 ft. (1.8 m)

1246311

EZ-Stop Arc Flash Lanyard

Polyurethane coated web, web loop at one end, snap hook at other end x 6 ft. (1.8 m)

1246324

EZ-Stop Arc Flash Lanyard

With Nomex®/Kevlar® fiber web, floating D-ring for choke, snap hook at ends x 6 ft. (1.8 m)

1246320

EZ-Stop Arc Flash Lanyard

Twin-leg Force2 with adjustable Nomex®/Kevlar® fiber webbing and snap hooks at ends x 6 ft. (1.8 m)



1246306



EZ-Stop

Leading Edge Shock-Absorbing Lanyards

Engineered for sharp edges, these lanyards incorporate edge certified cable construction and offer Force2 foot-level tie-off ability (for maximum 12 ft. free fall).



1246066

EZ-Stop Leading Edge Lanyard

Single-leg with snap hooks at each end x 6 ft. (1.8 m)

1246178

EZ-Stop Leading Edge Lanyard

Twin-leg with aluminum snap hook at center and aluminum locking rebar hooks at leg ends x 6 ft. (1.8 m)

1246261

EZ-Stop Leading Edge Lanyard

Single-leg with snap hook at one end, steel rebar hook at the other end x 6 ft. (1.8 m)

1246068

EZ-Stop Leading Edge Lanyard

Twin-leg with aluminum snap hooks at center and at each leg x 6 ft. (1.8 m)



3M™ DBI-SALA® EZ-Stop™

Retrax™ Lanyards

Unique spring technology retracts and expands from 2-1/2 ft.-6 ft. in reaction to user's movements.



1241480

EZ-Stop Retrax Lanyard

Twin-leg with snap hooks at each end x 6 ft. (1.8 m)



1241460

EZ-Stop Retrax Lanyard

Single-leg with snap hooks at each end x 6 ft. (1.8 m)

1241461

EZ-Stop Retrax Lanyard

Single-leg with snap hook and flat steel rebar hook x 6 ft. (1.8 m)

1241462

EZ-Stop Retrax Lanyard

Single-leg with snap hook and aluminum rebar hook x 6 ft. (1.8 m)

1241481

EZ-Stop Retrax Lanyard

Twin-leg with snap hook and flat steel rebar hooks at leg ends x 6 ft. (1.8 m)

1241482

EZ-Stop Retrax Lanyard

Twin-leg with snap hook and aluminum rebar hooks at leg ends x 6 ft. (1.8 m)

Shock-Absorbing Lanyards



EZ-Stop

Web Loop Lanyards

Simply choke off to back D-ring or to dorsal web loop. Reduces weight and is ideal for electrical applications where no metal above the waist is preferred.

1246104

EZ-Stop Web Loop Lanyard

Single-leg with snap hook at one end and web loop at other x 6 ft. (1.8 m)

Shock-Absorbing Lanyards

3M™ DBI-SALA® Force2™

Shock-Absorbing Lanyards

Ideal when there is no overhead anchorage and your only option is to tie off at your feet. It can be used for up to a 12 ft. (3.7 m) free fall and limits the average forces below 1,800 lbs. (8 kN) It can also be used as a standard lanyard up to a 6 ft. free fall for workers that require a capacity of 311 lbs.-420 lbs. (141 kg-190 kg)



1246167
Force2 Lanyard

Single-leg with snap hooks at each end x 6 ft. (1.8 m)



1246159
Force2 Lanyard

Twin-leg with snap hook and flat steel rebar hooks at leg ends x 6 ft. (1.8 m)

1246161
Force2 Lanyard

Twin-leg with snap hooks at each end x 6 ft. (1.8 m)



1246143
Force2 Lanyard

Twin-leg with snap hook at one end, Saflok™ Max Steel Rebar Hook (3 in. gate opening) at leg ends x 6 ft (1.8 m)

1246147
Force2 Lanyard

Twin-leg, elastic webbing with snap hooks at ends x 6 ft. (1.8 m)



1246130
Force2 Shock Absorber

Shock absorber only, snap hook on one end, D-ring on other end x 1.4 ft. (0.4 m)

1246145
Force2 Lanyard

Elastic legs, twin-leg, aluminum hook x 6 ft. (1.8 m)

1246272
Force2 Lanyard

Twin-leg, rope legs, steel rebar hooks x 6 ft. (1.8 m)



1246273
Force2 Lanyard

Rope, twin-leg, aluminum snap hook at one end, aluminum rebar (2-1/2 in. gate opening) at ends x 6 ft. (1.8 m)

3M™ DBI-SALA® WrapBax™2

Tie-Back Lanyards

Reduce inventory. Simplify inspections and training. The WrapBax2 eliminates the need for a separate anchorage connector, improving both your bottom line and compliance. It offers a unique 5,000 lb. (22 kN) hook and heavy-duty webbing for abrasion resistance. Limits the average arresting force to 900 lbs. (4 kN) or less.



1246229 WrapBax2 Tie-Back Lanyard

Single-leg with snap hook and 5,000 lb. (22 kN) WrapBax Hook x 6 ft. (1.8 m)

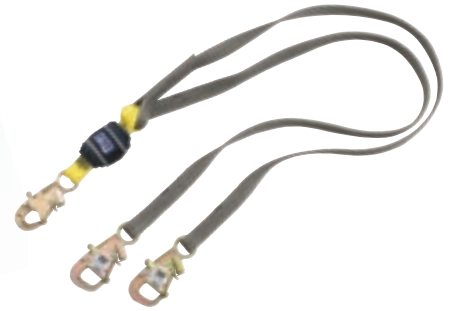

1246080 WrapBax2 Tie-Back Lanyard

Twin-leg with snap hook and 5,000 lb. (22 kN) WrapBax Hooks at leg ends x 6 ft. (1.8 m)

1246173 WrapBax2 Tie-Back Lanyard

Single-leg Force2™ with snap hook and 5,000 lb. (22 kN) WrapBax Hook x 6 ft. (1.8 m)

1246075 WrapBax2 Tie-Back Lanyard

Twin-leg Force2 with snap hook and 5,000 lb. (22 kN) WrapBax Hooks at leg ends x 6 ft. (1.8 m)

3M™ DBI-SALA® Force2

Wind Energy Lanyards



1246032 Force2 Wind Energy Lanyard

Twin-leg with elastic webbing, aluminum snap hook and rebar hooks at leg ends, Tech-Lite™ Rescue D-rings, nylon shock pack with PVC cover x 6 ft. (1.8 m) Global compliance OSHA, ANSI and CE.

1246153 Force2 Wind Energy Lanyard

Twin-leg with elastic web, snap hook and aluminum rebar hooks at leg ends, integrated rescue D-rings x 6 ft. (1.8 m)

1246030 Force2 Wind Energy Lanyard

Twin-leg with elastic web, snap hook and steel rebar hooks at leg ends x 6 ft. (1.8 m)



1246152 Force2 Wind Energy Lanyard

Twin-leg with elastic web, snap hook and Saflok™ Max Hooks on leg ends, integrated rescue D-rings x 6 ft. (1.8 m)

1246151 Force2 Wind Energy Lanyard

Twin-leg with Hi-Vis elastic webbing, aluminum snap hook and aluminum rebar hooks on ends, integrated rescue D-rings x 6 ft. (1.8 m)

1246208 Force2 Wind Energy Lanyard

Twin-leg with elastic web, snap hook and Saflok Max Hooks at leg ends x 6 ft. (1.8 m)

Positioning Lanyards

3M™ DBI-SALA®

Positioning Web Lanyards

Lanyards without shock absorbers, such as rope or web lanyards and chain rebar assemblies, are designed for positioning or restraint applications.

1 in. polyester web construction for durability that will last. Available in various lengths.

1231016 Web Lanyard

Single-leg with 1 in. polyester web, adjustable length and snap hooks at each end x 6 ft. (1.8 m)

1231106 Web Lanyard

Single-leg with 1 in. polyester web and snap hooks at each end x 6 ft. (1.8 m)

1231102 Web Lanyard

Single-leg with 1 in. polyester web and snap hooks x 2 ft. (0.6 m)

1231103 Web Lanyard

Single-leg with 1 in. polyester web and snap hooks x 3 ft. (0.9 m)

1231104 Web Lanyard

Single-leg with 1 in. polyester web and snap hooks x 4 ft. (1.2 m)

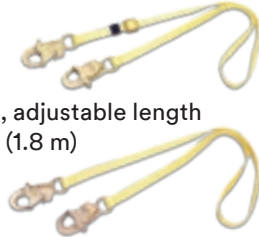

Positioning Rope Lanyards

Nylon or polyester rope available in various lengths with exclusive five-tuck splice and seizing method to hold the connection and prevent unweaving.

1232354 Nylon Rope Lanyard

Single-leg 1/2 in. nylon rope with snap hooks at each end x 6 ft. (1.8 m)

1232210 Polyester Rope Lanyard

Single-leg 1/2 in. polyester rope with adjustable length and snap hooks at each end x 6 ft. (1.8 m)

1232209 Nylon Rope Lanyard

Single-leg 1/2 in. nylon rope with adjustable length and snap hooks at each end x 6 ft. (1.8 m)

1232306 Polyester Rope Lanyard

Single-leg 1/2 in. polyester rope with snap hooks at each end x 6 ft. (1.8 m)

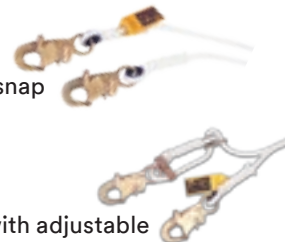

Chain & Web Rebar Positioning Lanyards

Made of twist link chain or polyester web for strength and durability. A variety of hook options provide a safe and compatible connection to many types of structures.

5920059 Chain Rebar Assembly

With snap hooks and swiveling Saflok™ Max Hook at center x 24 in. (60 cm)

5920050 Chain Rebar Lanyard

Chain rebar assembly with snap hooks and swiveling flat steel rebar hook at center x 20.5 in. (52 cm)

5920051 Chain Rebar Lanyard

Chain rebar assembly with snap hooks and swiveling aluminum rebar hook at center x 22 in. (56 cm)

5920080 Chain Rebar Lanyard

Chain rebar assembly with snap hooks and aluminum rebar hook at center x 20.5 in. (52 cm)

5920101 Chain Rebar Lanyard

Chain rebar assembly with snap hooks and swiveling 2000114 carabiner at center x 22 in. (56 cm)

1231380 Web Rebar Assembly

With snap hooks and aluminum rebar hook at center x 18 in. (45 cm)

1231389 Web Rebar Lanyard

Web rebar assembly with snap hooks and Saflok Max Hook at center x 18 in. (45 cm)

1231520 Web Rebar Lanyard

Web rebar assembly with snap hooks and swiveling aluminum hook at center x 22 in. (56 cm)

2108403 Spreader Hook

Use with large carabiner to form a positioning assembly that is short and compact. Steel hooks with self-locking/closing 3,600 lb. (16 kN) gates.



3M™ DBI-SALA® Cynch-Lok™

Fall-Restricting Devices

Real world challenges demand real world solutions. That's why we worked directly with actual pole climbers to develop Cynch-Lok Fall-Restricting Devices. You can effortlessly adjust and cinch it around the pole during a "cut-out" and easily hitch-hike poles (move or jump the strap upwards past obstacles) with a hand position that's comfortable.

Exterior straps can easily be swapped out in the field depending on pole size, eliminating the need for multiple systems. Cynch-Lok meets CSA Z259.14 standards for Type A and AB (dry, wet and icy poles) and ASTM F887.



Positioning Lanyards

1204057

Cynch-Lok Rope for Distribution Poles

Pole Size (Dia/Circ): Min 5-1/2 in./17-1/2 in.-
Max 18-1/2 in./58 in., Weight: 4.8 lbs. (2.1 kg)

1204058

Cynch-Lok Rope for Transmission Poles

Pole Size: (Dia/Circ): Min 5-1/2 in./17-1/2 in.-
Max 30-1/2 in./96 in., Weight: 5.3 lbs. (2.4 kg)

1204075

Cynch-Lok Web for Distribution Poles

Pole Size (Dia/Circ): Min 5-1/2 in./17-1/2 in.-
Max 18-1/2 in./58 in., Weight: 4.9 lbs. (2.2 kg)

1204076

Cynch-Lok Web for Transmission Poles

Pole Size: (Dia/Circ): Min 5-1/2 in./17-1/2 in.-
Max 30-1/2 in./96 in., Weight: 5.4 lbs. (2.4 kg)

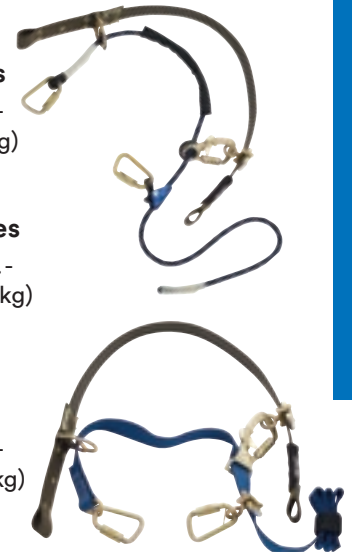

Cynch-Lok Replacement Components

1200110

Cynch-Lok Replacement Strap for Distribution Poles

Pole Size (Dia/Circ): Min 5-1/2 in./
17-1/2 in. Max 18-1/2 in./58 in.,
Weight: 1.9 lbs. (.86 kg)



1200115 (not shown)

Cynch-Lok Replacement Rope Interior Strap

Weight: 2.9 lbs. (1.3 kg)

1200136 (not shown)

Cynch-Lok Replacement Web Interior Strap

Weight: 3 lbs. (1.3 kg)

1204077 (not shown)

Cynch-Lok Left Carabiner Conversion Kit - Web

1204074 (not shown)

Cynch-Lok Left Carabiner Conversion Kit - Rope

1200111

Cynch-Lok Replacement Strap for Transmission Poles

Pole Size: (Dia/Circ): 5-1/2 in./17-1/2 in. Max 30-1/2 in./
96 in., Weight: 2.4 lbs. (1.1 kg)

Additional Positioning Lanyards

1234083

Adjustable rope positioning lanyard with Technora® kernmantle rope, rope adjuster and aluminum carabiners on ends x 8 ft. (2.4 m)



1234080

Adjustable rope positioning lanyard with rope adjuster and aluminum carabiners on ends x 8 ft. (2.4 m)



1234071

Adjustable rope positioning lanyard with rope adjuster and aluminum snap hook on one end and carabiner on the other x 8 ft. (2.4 m)



1234070

Adjustable rope positioning lanyard with rope adjuster and steel snap hook on one end and carabiner on the other x 8 ft. (2.4 m)





Self-Retracting Lifelines

**Up here, trust
gear that
works as hard
as you do.**





More innovations. More versatility

When there's nothing between you and the ground but clouds, you want the most reliable, advanced Self-Retracting Lifeline (SRL) to have your back every time.

That's why we've pioneered so many industry-firsts, including the 3M™ DBI-SALA® Nano-Lok™ edge, which is specifically designed for foot level tie-off and sharp edge applications often found in construction. It is ergonomically designed for ease-of-use and is ideal for direct connection to most harnesses. The extremely compact and lightweight design is virtually unnoticeable on your back, staying out of the worker's way and making it ideal as a lanyard replacement.

Whether your application requires single or twin-leg configurations, mounting to an overhead anchor or for connection directly to harness, there are numerous models to choose from to suit almost any application. Nano-Lok locks quickly—stopping a fall within inches—providing more protection at low heights.

3M™ DBI-SALA® Nano-Lok™

Self-Retracting Lifeline

Keep safe while hardly noticing you're wearing an SRL at all. The Nano-Lok SRL is ergonomically designed for ease-of-use and is ideal for direct connection to most harnesses. It stays out of the way and can be easily used as a lanyard replacement. Nano-Lok locks quickly—stopping a fall within inches—providing more protection at low heights. In addition, tension is always kept on the lifeline, which reduces dragging, snapping and trip falls.

1 Twin-leg anchorage connector

Attach two SRLs directly to back of most harnesses; installs to web—leaves dorsal D-ring open for other equipment or rescue; design provides snug fit to worker's back; interchangeable SRLs allow versatility and replacement options.

2 Centrifugal brake

Stops falling worker within inches—reduces fall distances and average arresting forces to 900 lbs. or less; replaces lanyard and improves safety.

3 Impact-resistant housing

High-strength housing provides maximum durability.

4 Impact indicator

Integrated shock absorber provides visual indication of a fall.

5 RFID equipped

Helps track equipment and manage safety inspection programs.

Model shown
3101277

- Extremely compact & lightweight
- 420 lb. weight capacity
- Wide variety of configurations



Direct-to-harness connection

Single-Leg or twin-leg connectors install underneath the webbing on most harnesses.

- Leaves D-ring open for other equipment or rescue.
- Provides snug fit to workers back—eliminates nuisance flopping.
- Lower attachment point keeps housing at shoulder level vs. head level.

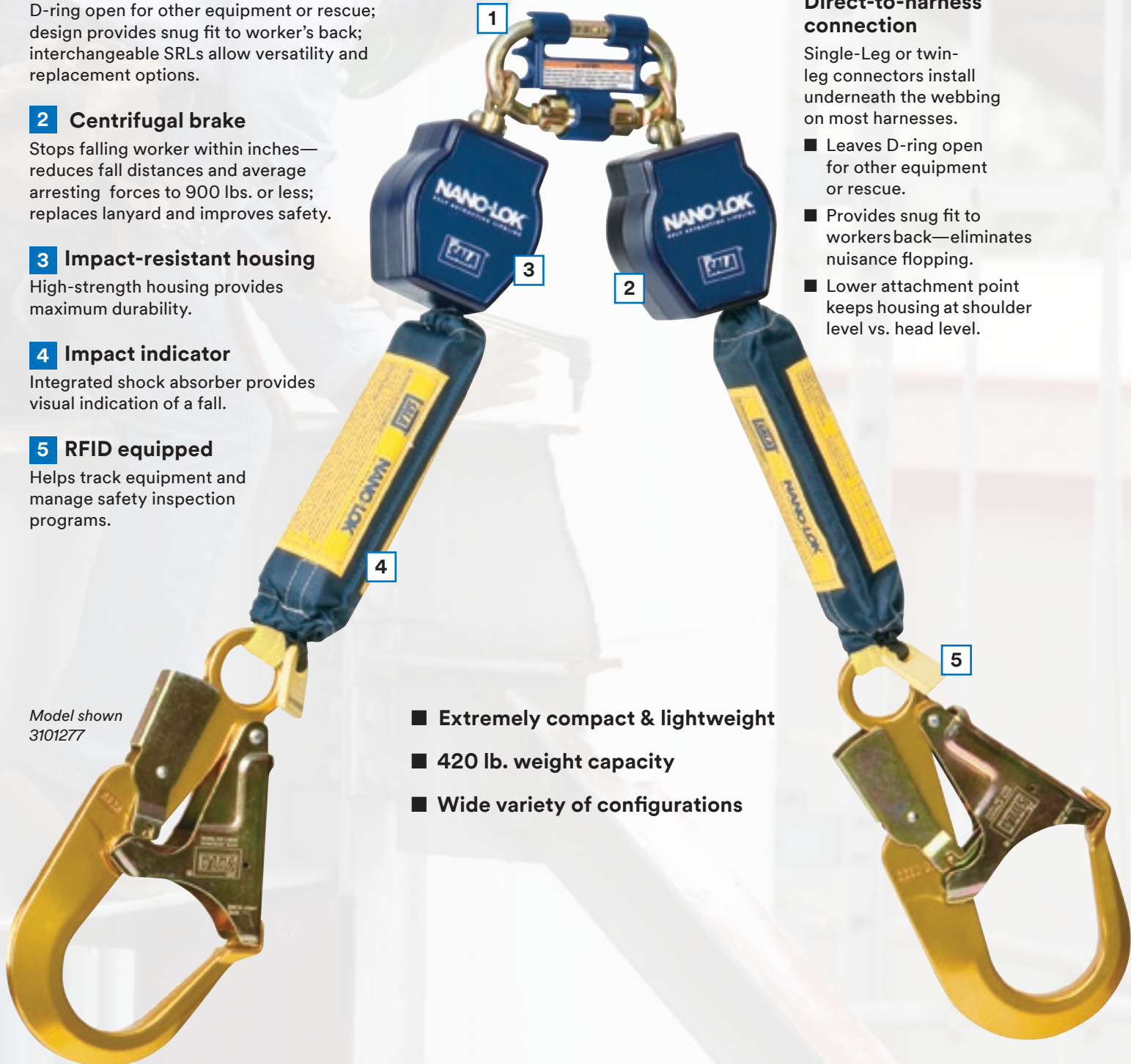

Self-Retracting Lifelines

3M™ DBI-SALA® Nano-Lok™

Single-Leg Self-Retracting Lifelines

3101215
Nano-Lok Self-Retracting Lifeline
 With Steel Snap Hook and Steel Carabiner
 x 6 ft. (1.8 m)



3101225
Nano-Lok Self-Retracting Lifeline
 With Aluminum Carabiner (Captive Eye) and Single-Leg Quick Connector
 x 6 ft. (1.8 m)



3101227
Nano-Lok Self-Retracting Lifeline
 With Aluminum Rebar Hook and Single-Leg Quick Connector
 x 6 ft. (1.8 m)



3101228
Nano-Lok Self-Retracting Lifeline
 With Steel Snap Hook and Single-Leg Quick Connector
 x 6 ft. (1.8 m)



3101229
Nano-Lok Self-Retracting Lifeline
 With Single-Leg Quick Connector and Steel Rebar Hook
 x 6 ft. (1.8 m)



3101254
Nano-Lok Self-Retracting Lifeline
 With Aluminum Rebar Hook
 x 6 ft. (1.8 m)



Self-Retracting Lifelines

Nano-Lok

Twin-Leg Self-Retracting Lifelines

3101273
Nano-Lok Twin-Leg Self-Retracting Lifeline
 With Twin-Leg Fixed Quick Connector and two Aluminum Rebar Hooks
 x 6 ft. (1.8 m)



3101277
Nano-Lok Twin-Leg Self-Retracting Lifeline
 With Twin-Leg Quick Connector and two Aluminum Rebar Hooks
 x 6 ft. (1.8 m)



3101279
Nano-Lok Twin-Leg Self-Retracting Lifeline
 With two Steel Snap Hooks and Twin-Leg Connector
 x 6 ft. (1.8 m)



3101280
Nano-Lok Twin-Leg Self-Retracting Lifeline
 With Steel Rebar Snap Hook and Single-Leg Quick Connector
 x 6 ft. (1.8 m)



3101288
Nano-Lok Twin-Leg Self-Retracting Lifeline
 With Twin-Leg Fixed Quick Connector and two Steel Rebar Hooks
 x 6 ft. (1.8 m)



3101473
Nano-Lok Twin-Leg Quick-Connect Self-Retracting Lifeline
 With two Aluminum Locking Rebar Hooks
 x 6 ft. (1.8 m)



Self-Retracting Lifelines

3M™ DBI-SALA® Nano-Lok™

Extended Length Self-Retracting Lifelines

3101582
Nano-Lok
Extended Length
Quick-Connect
Self-Retracting
Lifeline
With Anchor Hook
x 11 ft. (3.35 m)



3101586
Nano-Lok
Extended Length
Self-Retracting
Lifeline
With Anchor Hook
x 11 ft. (3.35 m)



3101621
Nano-Lok
Extended Length
Twin-Leg
Quick-Connect
Self-Retracting
Lifeline
With Snap Hook
x 11 ft. (3.35 m)



3101590
Nano-Lok
Extended Length
Quick-Connect
Self-Retracting
Lifeline
With Aluminum
Rebar Hook x 11 ft.
(3.35 m)



3101624
Nano-Lok
Extended Length
Twin-Leg Quick-
Connect Self-
Retracting Lifeline
With Aluminum
Rebar Hooks x 11 ft.
(3.35 m)



3101625
Nano-Lok
Extended Length
Twin-Leg Quick-
Connect Self-
Retracting Lifeline
With Aluminum Rebar
Hooks x 11 ft. (3.35 m)



Nano-Lok Tie-Back Self-Retracting Lifelines

NANO-LOK TIE-BACK SRL		U.S. Part Number
Single Leg	Nano-Lok Tie-Back, 5,000 lb. gated snap hook with swiveling anchor loop only x 9 ft. (2.7 m)	3101368
	Nano-Lok Tie-Back, 5,000 lb. gated snap hook with aluminum carabiner x 9 ft. (2.7 m)	3101365
	Nano-Lok Tie-Back, 5,000 lb. gated snap hook with single leg connector x 9 ft. (2.7 m)	3101366
	Nano-Lok Tie-Back, 5,000 lb. gated snap hook with steel carabiner x 9 ft. (2.7 m)	3101367
Twin Leg	Nano-Lok Tie-Back, 5,000 lb. gated snap hook with twin leg quick-connector x 9 ft. (2.7 m)	3101374
	Nano-Lok Tie-Back, 5,000 lb. gated snap hook with fixed D-ring connector x 9 ft. (2.7 m)	3101373



3M™ DBI-SALA® Nano-Lok™ Arc Flash Self-Retracting Lifelines



	Lifeline hook											Anchorage type				U.S. Part Number
	Steel Snap Hook	Steel Swiveling Snap Hook	Steel Rebar Hook	Steel Rebar Lock Hook	Aluminum Captive Carabiner	Aluminum Rebar Hook	Aluminum Rebar Lock Hook	Dielectric Web Loop	11' Tie-Back	Single-Leg Interface	Twin-Leg Interface	Steel Carabiner	Web Leg w/ Alum. Snap Hook			
8 ft. Single Leg	■													3101526		
		■												3101527		
			■											3101528		
				■										3101529		
					■									3101530		
						■								3101531		
							■							3101532		
								■						3101533		
		■											■	3101562		
										■				3101563		
8 ft. Twin Leg	■													3101534		
		■												3101535		
			■											3101536		
				■										3101537		
					■									3101538		
						■								3101539		
							■							3101540		
								■						3101565		
									■					3101574		
										■				3101575		

Designed specifically for utility applications.

- 8 ft. (2.4 m) working length.
- With Nomex®/Kevlar® fiber web lifeline and reinforced edges for superior wear resistance and durability.
- Features an arc flash industry logo to easily identify the product application.
- Arc flash compliant, tested to 40 cal/cm². Meets ASTM F887.
- Meets or exceeds industry standards.



Self-Retracting Lifelines

Nano-Lok for Hot Work Use Self-Retracting Lifelines



	Lifeline hook										Anchorage type			U.S. Part Number
	Steel Snap Hook	Steel Swiveling Snap Hook	Steel Rebar Hook	Steel Rebar Lock Hook	Aluminum Captive Carabiner	Aluminum Rebar Hook	Aluminum Rebar Lock Hook	9 ft. Tie-Back	Single-Leg Interface	Twin-Leg Interface	Steel Carabiner			
6 ft. Single Leg	■												3101491	
		■											3101492	
			■										3101493	
				■									3101494	
					■								3101495	
						■							3101496	
							■						3101497	
		■											■	3101498
														3101322
														3101324
6 ft. Twin Leg	■												3101499	
		■											3101500	
			■										3101501	
				■									3101502	
					■								3101503	
						■							3101504	
							■						3101505	
								■					3101326	

This unique SRL was tested to 8 calories, ensuring durability in applications like welding, grinding and torching.

It is reinforced with Kevlar® fiber to withstand sparks, weld splatter and other high heat exposure.

- 6 ft. (1.8 m) working length
- Universal hot work icon to quickly and easily identify hot work products.
- Equipped with RFID.
- Meets or exceeds industry standards.



3M™ DBI-SALA® Nano-Lok™ edge

Self-Retracting Lifeline

The Nano-Lok edge SRL is specifically designed for foot level tie-off and sharp edge applications. It uses an innovative combination of lifeline material, energy absorption, and its harness connection to reduce forces on both the wearer and the edge. This technology allows Nano-Lok edge to meet the most stringent safety standards. It's available in single and twin-leg units, and it's orange so you'll know it's the right gear for the job.

1 Easy-to-install connector

Providing 360 degrees of rotation, the direct-to-harness connection provides seamless integration of the energy absorber and leaves the D-ring open for rescue or other equipment.

2 Impact-resistant housing

Lightweight thermoplastic housing provides maximum durability.

3 Global sharp edge icon

Our universal icon makes identification of sharp edge product quick and easy.

4 Tough and flexible galvanized cable lifeline

The 8 ft. (2.4 m) of 3/16 in. (5 mm) cable provides maximum range of motion, durability, and cut resistance.

5 Integrated, backpack-style energy absorber

The energy absorber and connector work together to limit forces on both the worker and the impacted edge. Backpack design stays tight to the harness and evenly disperses the unit's weight.



Model shown
3500225

You work on the edge. We'll keep you dry.

Self-Retracting Lifelines

3M™ DBI-SALA® Nano-Lok™ edge Self-Retracting Lifelines

In your line of work, anchoring at your feet may be the only option. Traditional equipment is not designed for this application, and slack could literally trip you up. The Nano-Lok edge is specifically designed for foot level tie-off, virtually eliminating that hazard. Not only that, but this lifeline is designed with sharp edges in mind and takes the guesswork out of your work. The technology speaks for itself.

You can find more detailed information on how the Nano-Lok edge keeps you safe on our website. Visit 3M.com/FallProtection



Model shown
3500216

Product selection guide

		Lifeline hook								SRL	
		Tie-back	Alum. Rebar Lock Hook	Steel Rebar Lock Hook	Alum. Rebar Hook	Steel Rebar Hook	Steel Snap Hook	Steel Swivel Snap Hook	Alum. Captive Carabiner	Alum. Snap Hook	U.S. Part Number
Twin Leg		■									3500228
			■								3500231
				■							3500227
					■						3500249
						■					3500246
							■				3500225
								■			3500226
Single Leg									■		3500229
										■	3500230
		■									3500213
			■								3500216
				■							3500212
					■						3500247
						■					3500248
						■				3500210	
							■			3500211	
								■		3500214	
									■	3500215	

*All versions are 8 ft. in length except tie-back models. Tie-back versions are 9 ft.

3M™ DBI-SALA® Sealed-Blok™

Self-Retracting Lifeline

Grease, dirt and moisture are just part of your job. Keeping them from affecting the performance of your SRL is ours. These sealed SRLs are constructed from heavy-duty, corrosion-resistant materials, and incorporate a patented concept that separates all dynamic components—including the motor spring and brake—from foreign elements.

1 Carrying handle

Built-in design for easy transport—certified as secondary fall arrest rated anchorage point.

2 Galvanized & stainless steel cable

Abrasion resistant and corrosion-resistant lifeline options.

3 Self-locking swivel hook

- Limits lifeline twisting
- Integrated impact indicator
- 3,600 lb. gate reduces accidental disengagements (“roll-out”)

4 Fast-Line™

Provides the user with ability to replace the lifeline in the field.

5 Pivoting anchorage loop

Centers the load.

6 Aluminum housing

Provides exceptional strength durability and corrosion resistance.

7 Aluminum cast cover

Sealed design

Meets IP68 and IP69K rating.



3400902
Model shown

Anti-ratcheting design

Stays locked on rigid and non-rigid (horizontal lifeline) anchors.

420 lb. weight capacity (All non-RSQ models)

Higher capacity for operator and tools (option).

Self-Retracting Lifelines

3M™ DBI-SALA® Ultra-Lok™ Self-Retracting Lifelines

Rugged durability. Extremely lightweight. These SRLs are engineered to deliver everything you need to maximize your safety, efficiency and comfort. Stainless steel components, an anti-ratcheting brake system and a semi-sealed design result in a system that's truly built to last.

- 1 Top swivel**
Limits lifeline twisting for smoother operation.
- 2 Thermoplastic housing**
Lightweight, compact and durable.
- 3 Ergonomic cable handle**
Provides added comfort and ease-of-use when making connections.
- 4 Multiple lifeline options**
Galvanized or stainless steel cable, nylon or Nomex®/Kevlar® web, or Vectran™ rope for ultimate jobsite flexibility.
- 5 Self-locking swivel hook**
Limits lifeline twisting.
- 6 Impact indicator**
Provides visual indication of fall arrest.
- 7 3,600 lb. gate**
Reduces chances of accidental disengagement (“roll-out”).



Model Shown
3504450

3M™ DBI-SALA® Ultra-Lok™

Self-Retracting Lifelines

Like our Sealed-Blok, the Ultra-Lok Lifeline also extends and retracts, so you can move about freely at normal speeds within a recommended working area. Should a fall occur, a speed-sensing brake system (4.5 ft./sec.) will activate, stopping the fall and reducing the imposed forces to 900 lbs. (4 kN) or less.



3103108 Ultra-Lok Web SRL

Nylon web lifeline models weigh less, making them more comfortable and less abrasive to objects around system x 11 ft. (3.3 m)



3504500 Ultra-Lok Leading Edge SRL

Unique design incorporates larger diameter 30 ft. (9.1 m) of 7/32 in. cable and an in-line shock absorber for the demands of leading edge applications.



3103175 Ultra-Lok Arc Flash SRL

Kevlar®/Nomex® lifeline offers the ultimate in spark, fire resistance and electrical conductivity for utility, welding, cutting and torching applications x 11 ft. (3.3 m)



3501102 Ultra-Lok 3-Way SRL

50 ft. (15.2 m) of 3/16 in. (5 mm) galvanized steel wire rope with 3-way emergency retrieval winch, mounting bracket, swiveling snap hook and anchorage carabiner.

Lifeline material	Hook style	Hook throat size (in.)	Rated gate capacity (lbs.)	Swivel hook	Compatible with order picker mount**	Leading edge	RSQ	SRL weight capacity (lbs.)	11 ft.	15 ft.	20 ft.	30 ft.	50 ft.	55 ft.	85 ft.	
									(3.4 m)	(4.6 m)	(6.1 m)	(9.1 m)	(15.2 m)	(16.7 m)	(26 m)	
Galvanized cable	Steel carabiner	5/8	3,600	■				310			3504445	3504446	3504463			
	Steel hook	5/8	3,600	■		■		310		3504422		3504500		3504600		
		3/4	3,600	■			■	310			3504433	3504430	3504450		3504485	
Stainless steel cable	Steel hook	3/4	3,600	■			■	310					3504551			
		3/4	3,600	■			■	310			3504434	3504431	3504451		3504486	
	Stainless steel hook	3/4	3,600	■			■	310			3504437	3504432	3504452		3504487	
Vectran rope	Steel hook	3/4	3,600	■				310			3504438		3504480			
Nylon web	Steel carabiner	11/16	3,600					310			3103209					
			3,600	■				420	3103119							
	Stainless steel carabiner	11/16	3,600					310			3103214					
	Aluminum rebar hook	2 1/4	3,600		■			420	3103110							
	Steel hook	5/8	3,600	■	■			420	3103108							
				■	■			420	3103120							
				■				310		3103208						
				■				420	3103107							
							310			3103207						
Stainless steel hook	3/4	3,600	■	■			420	3103136								
			■				310		3103212							
Kevlar®/Nomex® Fiber web	Steel hook	5/8	3,600	■	■			310	3103175							
				■				310		3103275						
	Web loop (choker)	N/A	N/A		■			310	3103176							
Approximate web SRL weight									39 lbs. (18 kg)	-	5.5 lbs. (2.5 kg)	-	-	-	-	
Approximate cable (galv) SRL weight									8 lbs. (3.6 kg)	11 lbs. (5 kg)	9 lbs. (4.1 kg)	11 lbs. (5 kg)	15 lbs. (6.8 kg)	30 lbs. (13.6 kg)	33 lbs. (15 kg)	

Self-Retracting Lifelines

Self-Retracting Lifelines

3M™ DBI-SALA® Talon™

Self-Retracting Lifelines

An extremely compact SRL that's lighter, stronger and safer. Talon features an all-metal anti-ratcheting braking system that stops the fall within inches and reduces the forces imposed on the user to safe levels. Because of our unique brake system, you can maintain a normal work pace and not be interrupted with constant lockups.

- Lightweight design – under 3 lbs. (1.4 kg)
- Built-in connector for direct attachment to harness.
- Compact size and weight for comfort and convenience.

3101001

Talon Quick-Connect Self-Retracting Lifeline

1 in. (2.5 cm) nylon web with swivel snap hook and quick connector for harness mounting x 8 ft. (2.4 m)



3101009

Talon Order Picker Self-Retracting Lifeline

1 in. (2.5 cm) nylon web with swivel snap hook and cab-mount order picker connector x 8 ft. (2.4 m)



3101300

Talon Tie-Back Quick-Connect Self-Retracting Lifeline – Web

1 in. (2.5 cm) nylon web with tie-back hook and quick connector for harness mounting x 9.5 ft. (2.9 m)



3101006

Talon Quick-Connect Self-Retracting Lifeline – Web

1 in. (2.5 cm) nylon web with quick connector and 9510057 Flat Steel Rebar Hook with 2-1/2 in. (62.5 mm) gate opening x 8 ft. (2.4 m)



3M™ DBI-SALA® Talon™

Twin-Leg Self-Retracting Lifelines

Work safer with greater mobility. The Talon Twin-Leg SRL allows you to “leap-frog” while moving from one location to another. Each lifeline works independently, extending up to 6 ft. and automatically retracting, providing fall protection and mobility 100% of the time.

- Twin-leg SRL provides continuous protection.
- Built-in anchorage connector for direct attachment to harness or anchorage.
- Compact size and weight for comfort and convenience.
- Replaces a lanyard with the convenience of a retractable lifeline.
- All Talon Twin-Leg SRLs include Delta™ Comfort Pad and 2 ea. Lanyard Keepers

3102100

Talon Twin-Leg Tie-Back Quick-Connect Self-Retracting Lifeline – Web

Tie-back type twin-leg lifelines with 1 in. (2.5 cm) nylon web and tie-back hooks, quick connector for harness mounting x 7.5 ft. (2.3 m)



3102000

Talon Twin-Leg Quick-Connect Self-Retracting Lifeline – Web

Twin-leg lifelines with 1 in. (2.5 cm) nylon web, quick connector for harness mounting, aluminum rebar hooks x 6 ft. (1.8 m)



3102003

Talon Twin-Leg Quick-Connect Self-Retracting Lifeline

Twin-leg lifelines with 1 in. (2.5 cm) nylon web, quick connector for harness mounting, steel rebar hooks x 6 ft. (1.8 m)

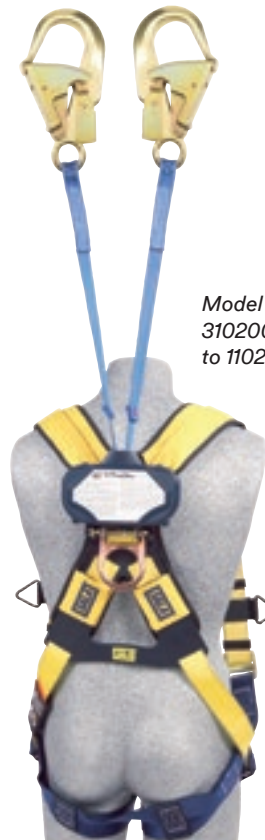

Model shown
3102000 attached
to 1102000 harness

3102115

Talon Twin-Leg Tie-Back Quick-Connect Self-Retracting Lifeline

Tie-back type twin-leg lifelines with 1 in. (2.5 cm) nylon web and tie-back hooks, quick connector for harness mounting x 7.5 ft. (2.3 m) 420 pound capacity.





Vertical Systems

Security and confidence at height.





Take that feeling of security with you all the way up. 3M™ DBI-SALA® Vertical Systems are designed to complement your ability to work while meeting all applicable OSHA and ANSI standards. That makes them the industry's premier choice for vertical safety systems.

Types of vertical lifeline systems

A vertical fall protection system allows the worker to move up and down the entire height of the lifeline rather than having to disconnect and find new tie-off points along the way. Some important considerations when selecting a system include:

Portable or permanent

Temporary jobs require lightweight and easy-to-use portable systems with synthetic lifelines that can be moved from one location to another. If a structure is accessed often, such as a ladder or tower, a permanent solution, such as Lad-Saf™ or Railok™ 90, is a better choice. Permanent systems require corrosion-resistant galvanized or stainless steel lifelines.

Mobile or fixed

Mobile rope grab or ladder sleeve designs automatically follow the user for easy operation. Fixed devices allow the user to fix the unit in place for positioning or restraint applications.

Vertical Systems

3M™ DBI-SALA® Lad-Saf™

Flexible Cable Ladder Safety Systems

Make your structure permanently safe and accessible with the easy-to-use Lad-Saf Flexible Cable System. It consists of a top and bottom bracket that act as anchors for a steel cable that runs the length of the climbing area. The Lad-Saf X3 Sleeve, attached by a carabiner to the harness, arrests falls by locking onto the cable.

Welded or bolted. Straight or curved ladders. Wood, concrete or steel structures. A variety of rung clamp sizes and styles. With so many optional configurations, these versatile and economical safety solutions are ideal for many applications.

1 Standard top bracket

Galvanized top bracket with mounting hardware. For systems up to 499 ft. (152 m) high, fits up to 1-1/8 in. (2.85 cm) rung diameter and attaches to three rungs. Includes built-in energy absorber.

2 Standard bottom bracket

Fits up to 1-1/8 in. (2.85 cm) rung diameter and attaches to two rungs. Galvanized bottom bracket includes built-in tension indicator.

3 Cable guide

Non-metallic cable guide with mounting hardware. For systems up to 199 ft. (60.6 m), fits up to 1-1/8 in. (2.85 cm) rung diameter. Recommend one every 25 ft. (7.6 m)

4 Cable lifeline

Galvanized cable, 3/8 in. (9.5 mm) diameter, 1 x 7 type. Last three digits in part number indicate length.

5 Lad-Saf X3 Detachable Cable Sleeve

Climbing sleeve for better climbing performance and fall protection.



Easy to climb

The Lad-Saf X3 Sleeve automatically follows the climber during ascent or descent. In the event of a fall, the sleeve immediately locks onto the cable and remains locked until the user can regain his footing.

Tension indicator

Integrated tension-indicating bottom bracket takes the guesswork out of installation.

Customizable

Hundreds of different brackets, styles and configurations to suit almost any application.

Corrosion-resistant construction

Galvanized and stainless steel construction stands up to harsh environments for added longevity.

Shock-absorbing design

Integrated shock-absorbing top bracket reduces forces imposed on ladder structure during a fall.

Protected from wear

Intermediate cable guides prevent cable wear against the ladder while permitting the climber to bypass without disconnecting.

6100090
3M™ DBI-SALA® Lad-Saf™
Bottom Bracket

Standard galvanized bottom bracket with mounting hardware. Fits up to 1-1/8 in. (2.85 cm) rung diameter, attaches to two rungs, built-in tensioning device.



6100400
Lad-Saf Cable Guide

Non-metallic cable guide with mounting hardware. For systems up to 199 ft. (60.6 m), fits up to 1-1/8 in. (2.85 cm) rung diameter. Recommend one every 25 ft. (7.6 m)



6100515 Cable Guide (L-shaped) and hardware for systems over 200 ft. (61 m)

Lad-Saf Cable Lifeline

Durable high strength steel construction. Galvanized construction stands up to harsh environments for maintenance free longevity.



6116280
Lad-Saf Top Bracket

Standard galvanized top bracket with mounting hardware. For systems up to 499 ft. (152 m) high, fits up to 1-1/8 in. (2.85 cm) rung diameter, attaches to three rungs, built-in energy absorber.

6116410 Standard Top Bracket and hardware for systems over 500 ft. (152.4 m)



6160054
Lad-Saf X3
Detachable
Cable Sleeve

For use with 3/8 in. (9.5 mm) diameter 1 × 7 or 7 × 19 solid core cable. Comes with 2000112 carabiner. Meets OSHA and ANSI standards.

6160030 Lad-Saf X2 Detachable Cable Sleeve



Cable Lifeline general specifications and materials

	6110XXX	6152XXX	6130XXX	6154XXX
Diameter	3/8 in. (9.5 mm)	3/8 in. (9.5 mm)	3/8 in. (9.5 mm)	3/8 in. (9.5 mm)
Strand	1 × 7	1 × 7	7 × 19	7 × 19
Steel	Galvanized	Stainless	Galvanized	Stainless
Preformed	Left, Regular Lay	Left, Regular Lay	Right, Regular Lay	Right, Regular Lay
Compliance	ASTM A475	ASTM A368	RR-W-410	RR-W-410
Breaking strength	15,400 lbs. minimum	18,000 lbs. minimum	14,400 lbs. minimum	12,000 lbs. minimum

Last three digits in part number indicate length.



3M™ DBI-SALA® Lad-Saf™

Wood Pole (Bolt-On) Ladder Safety System

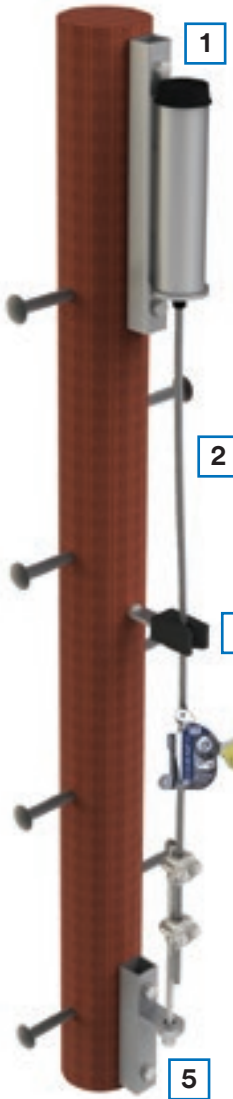

1 6116224
Top Bracket

Bolt-on top bracket with built-in energy absorber and fasteners.

2 6110000
Cable Lifeline

Galvanized cable, 3/8 in. (9.5 mm) diameter, 1 × 7 type. Last three digits in part number indicate length.

3 6100140
Cable Guide

Galvanized cable guide. Recommend one every 25 ft. (7.6 m)

4 6160054
Lad-Saf X3 Detachable Cable Sleeve

One-handed attachment or removal from the cable delivers fast, easy and safe connections.

5 6100045
Bottom Bracket

Galvanized bottom bracket with built-in tensioner. Bolts to wood pole.

Lad-Saf

Steel Pole Ladder Safety System

6100035
Bottom Bracket

Galvanized bolt-on bottom bracket with built-in tensioner.

6100136
Cable Guide

Flexible stainless steel cable guide support.

Angle iron, clamp-on, and steel pole weld-on systems also available. Call us today.



3M™ DBI-SALA® Lad-Saf™ Ladder Accessories



6116336 Grab Bar Extension

Slides into Top Bracket (6116054) of fixed ladder safety system and provides the user with a tie-off point (for lanyard) when connecting or disconnecting from the system's lifeline.

6116054 Top Bracket Assembly

For use with 6116336 (replaces standard 6116280 Top Bracket).



6147000 Telescoping Extension

Self-contained ladder safety system can be returned to its stored position when not in use below the opening so it can be covered.

Telescoping top bracket with hardware. Galvanized cable lifeline.

Counterweight to tension lifeline.

Order by length—last three digits in part number indicate length. 10 ft.-170 ft. lengths available (3.1 m-51.8 m)



6116038 Ladder Mast

Galvanized removable extension with pulleys, mounting bracket for winch/SRL.

6116027 Galvanized Bottom Mounting Bracket

Attaches 6116038 to ladder.

6116026 Ladder Anchor Post

Galvanized removable extension with eye-bolt anchor to attach 3-way SRL.

6116027 Galvanized Bottom Mounting Bracket

Attaches 6116026 to ladder.

5901980 Ladder Gate

Protects you from the dangers (and liability) of unauthorized ladder access.

Fits ladder widths up to 20 in. (50.8 cm). Mounting hardware included.

Aluminum construction 8 ft. (2.4 m) height x 36 in. (91.4 cm) width.

Vertical Systems

3M™ DBI-SALA®

Railok™ 90

Rigid Rail Ladder Safety Systems

Make existing ladders safe and easy to climb. The Railok 90 Rigid Rail System consists of top and bottom entry/exit gates, rail joints, and multiple mounting bracket options designed to mount the rigid aluminum rail to the structure.

A Railok 90 Shuttle connects the worker to the system and locks onto the rail in the event of a fall, allowing the user to regain their footing.

Designed for ease of use and versatility, you can configure to an existing ladder or customize a system with integrated ladder pegs when no ladder exists. Various clamps are available to attach to almost any structure.

Shock-absorbing design

Integrated metallic energy absorber in shuttle reduces forces imposed on system and worker.

Easy to climb

The Railok 90 Shuttle automatically follows the user and locks in the event of a fall.

Ladder rung clamps

Provide multiple anchor points to the structure for added safety.

Customizable

Many different clamps and configurations available to suit almost any need.

Corrosion-resistant construction

Aluminum, stainless steel and galvanized construction stands up to harsh environments for added longevity.



3M™ DBI-SALA®

Railok™ 90

Standard Ladder



1 6000352
Top Ladder Rail Gate
Aluminum and galvanized steel clamp with fastening hardware. Allows user to easily attach shuttle to the system and prevents accidental removal from the system.

2 6000120
Ladder Rung Clamp
Aluminum and galvanized steel clamp with fastening hardware. Attaches rail to ladder structure. Use within 1 ft. (0.3 cm) of rail splice and one at least every 5 ft. (1.5 m)

3 6000033
Standard Rail
Anodized extruded aluminum rail x 6.56 ft. (2 m)

6000031	3.25 ft. (1 m)
Rail Section	
6000032	9.84 ft. (3 m)
Rail Section	

4 6000100
Rail Joint
Aluminum and galvanized steel rail joint with fastening hardware. Attaches two rail sections together.

5 6000377
Railok 90 Shuttle
Climbing shuttle automatically follows user and locks onto rail during fall.

6 6000375
Bottom Standard Rail Gate
Aluminum and galvanized steel clamp with fastening hardware. Allows user to easily attach shuttle to the system and prevents accidental removal from the system.

Railok 90

Integrated Ladder

1 6000354
Top Ladder Rail Gate
Aluminum and galvanized steel clamp with fastening hardware. Allows user to easily attach shuttle to the system and prevents accidental removal from the system.

2 6000132
Angle Iron Clamp
Aluminum and galvanized steel clamp with fastening hardware. Attaches rail to angled iron structure. Other clamp styles available.

3 6000298
Step Bolt
Galvanized steel step bolt with fastening hardware. Attaches to ladder rail to create climbing pegs.

4 6000100
Rail Joint
Aluminum and galvanized steel rail joint with fastening hardware. Attaches two rail sections together.

5 6000307
Ladder Rail
Anodized extruded aluminum rail with step bolt holes x 7.87 ft. (2.4 m)

6000301	1.96 ft. (0.6 m)	Ladder Rail Section
6000302	2.95 ft. (0.9 m)	Ladder Rail Section
6000303	3.93 ft. (1.2 m)	Ladder Rail Section
6000304	4.92 ft. (1.5 m)	Ladder Rail Section
6000306	5.90 ft. (1.8 m)	Ladder Rail Section

6 6000377
Railok 90 Shuttle
Climbing shuttle automatically follows user and locks onto rail during fall.

7 6000375
Bottom Ladder Rail Gate
Aluminum and galvanized steel clamp with fastening hardware. Allows user to easily attach shuttle to the system and prevents accidental removal from the system.



Powering your climb.



Climb smarter—not harder—
with the 3M™ DBI-SALA®
Powered Climb Assist
System. It helps workers
climb internal ladders on
tall wind energy towers by
reducing the weight they
carry themselves. The result
is less fatigue and enhanced
climbing longevity to power
you through the work day.

3M™ DBI-SALA® Powered Climb Assist System for Wind Energy

Designed to be used in conjunction with a ladder safety system, such as the LadSaf™ Vertical System with Sleeve. It includes top and bottom pulley assemblies, wire cable, wire cable grip, motor control assembly and cable tensioning system.

Adjustable force settings

Motor control unit provides five discrete force level settings.

Adapts to environment

System provides a unique “adaptive” motor control system that adjusts to environmental conditions and climbing speed.

Effortless ascent and descent

Personalized system adjustment of 55-120 lbs. (25-55 kg) for a wide range of climbing styles and user weights.

Simple installation

Plug-n-play portable motor control unit design enables simple installation to cable tensioning unit. Plug the unit into the power outlet and you're ready to climb!

Global compatibility

System accommodates a power supply range of 110-240 Vac, 50-60 Hz (optional power cords available to match receptacles).

Maximum portability

20 lb. (9 kg) portable motor control unit is easily transported to support multiple systems and towers.

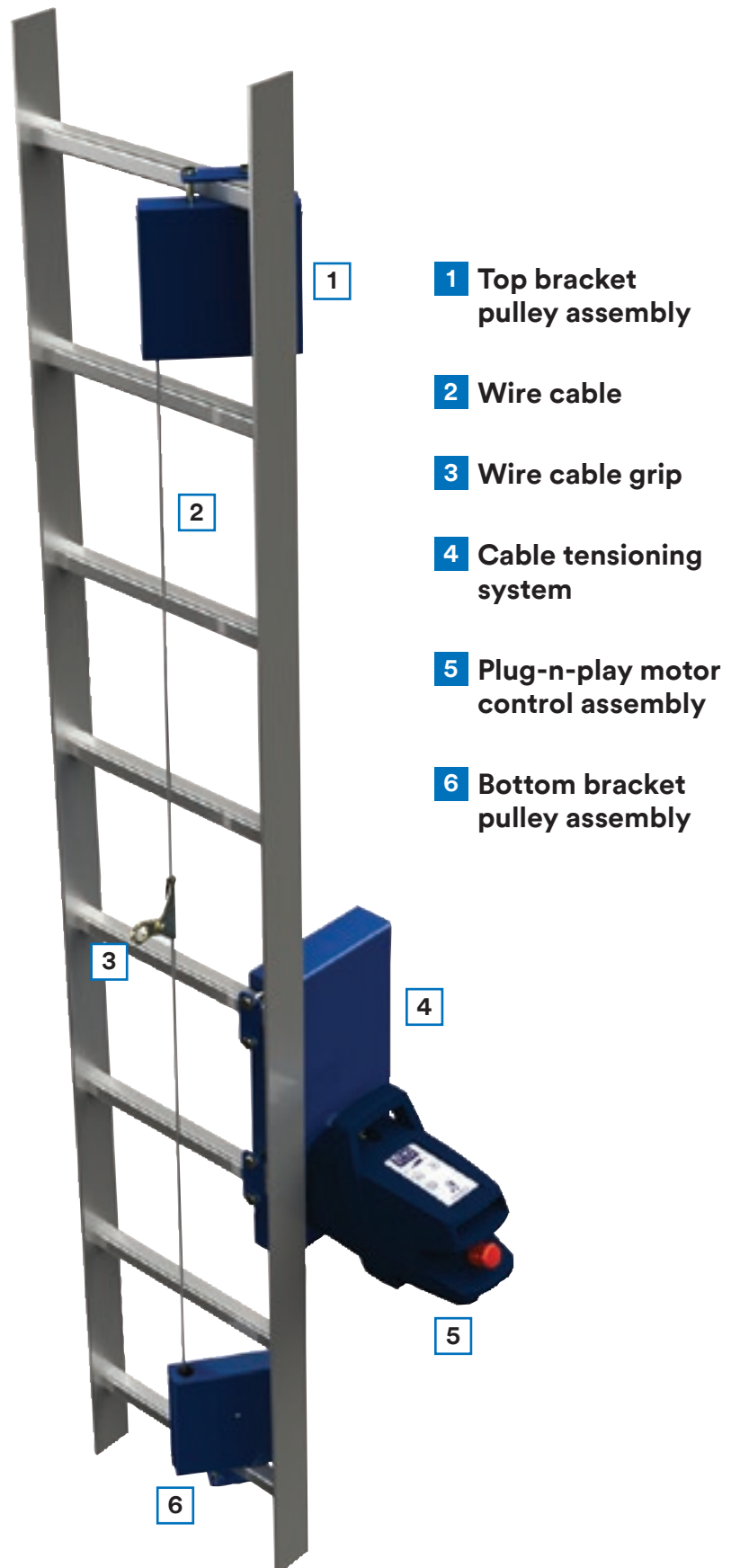

1 Top bracket pulley assembly

2 Wire cable

3 Wire cable grip

4 Cable tensioning system

5 Plug-n-play motor control assembly

6 Bottom bracket pulley assembly

Vertical Systems

3M™ DBI-SALA® Powered Climb Assist System

Tower Kit



1 6160039
Tower Kit

2 6160041
Tensioning Assembly

3 6160040
Top & Bottom
Bracket Pulley
Assemblies

4 6100031
Wire Cable Swage
Connections

5 6160027
Wear Pad Kit
Nylon pads, stainless steel
screws, and drill bit and tap.

6 6160028
Wire Cable
3/16 in. (4.8 mm) x 656 ft.
(200 m). 7 x 19 strand core.
Galvanized steel wire.

Accessories

6160026
Wire Cable Grip with Carabiner

Carabiner: 11/16 in. (17.7 mm) gate opening, 3,600 lb. (16 kN) gate strength, with captive eye installed. Wire Cable Grip: 3/16 in. (4.8 mm) cable sleeve.



6160024
Twin-Leg Lanyard Assembly
with Wire Cable Grip (optional)

Two Carabiners: 11/16 in. (17.7 mm) gate opening, 3,600 lb. (16 kN) gate strength, with captive eye installed. Wire Cable Grip: 3/16 in. (4.8 mm) cable sleeve. Webbing: Yellow nylon, 7/8 in. (22.2 mm) width x 11-1/4 in. (285.8 mm) length.

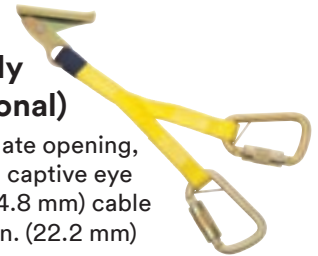

9600068
Wire Cable Cutter

Length: 28 in. (711 mm) shear-type manual wire rope and cable cutter. Weight: 4.75 lbs. (2.15 kg)



9600069
Hand Operated Swager

OEM: Huskie, Model EP-410.
Output: 12 ton. Weight: 13 lbs. (5.9 kg)
Length: 23 in. (584.2 mm)
Jaw Opening: 1 in. (25.4 mm)



9600003
Swage Die Kit

U-style shaped die set—specifically designed for Cable Swage Connection (6100031).



Portable Motor Control



6160051
Motor Control Assembly

Lightweight and portable at approximately 20 lbs. (9 kg). Globally compliant 120-240 Vac, 50-60 Hz. Operating temperature range: -22° F–131° F (-30° C–55° C). IP54 rating.

9506929 Power Cord
(NEMA 5-15P)

ExoFit NEX™ Wind Energy Harnesses

1113452
ExoFit NEX™ Powered Climb Assist Harness

Wind energy harness with 16 in. (406 mm) climb assist straps located off hips (XLarge). For use with Wire Cablegrip with Carabiner (6160026)—order separately. IP54 rating.

1113449 Small

1113450 Medium

1113451 Large

1113453 2X



1113457
ExoFit NEX™ Powered Climb Assist Construction Style Harness

Wind energy harness with 16 in. (406 mm) climb assist straps located off hips (XLarge). For use with Wire Cablegrip with Carabiner (6160026)—order separately.

1113454 Small

1113455 Medium

1113456 Large

1113458 2X



3M™ DBI-SALA®

SSB Climb Assist System

Achieve a safer, easier climb even in complex work environments. Our SSB Climb Assist System—with external counterweight—supports workers' motions and provides fall protection while climbing lengthy ladders and towers. It's ideal for on- and offshore drilling platforms where conditions can make climbing ladders hazardous.

Added safety

Counterweight includes a runaway brake as a backup safety measure.

Ultimate flexibility

No limit to length of system.

Enhanced durability

Aluminum housing and steel drum resist corrosion.

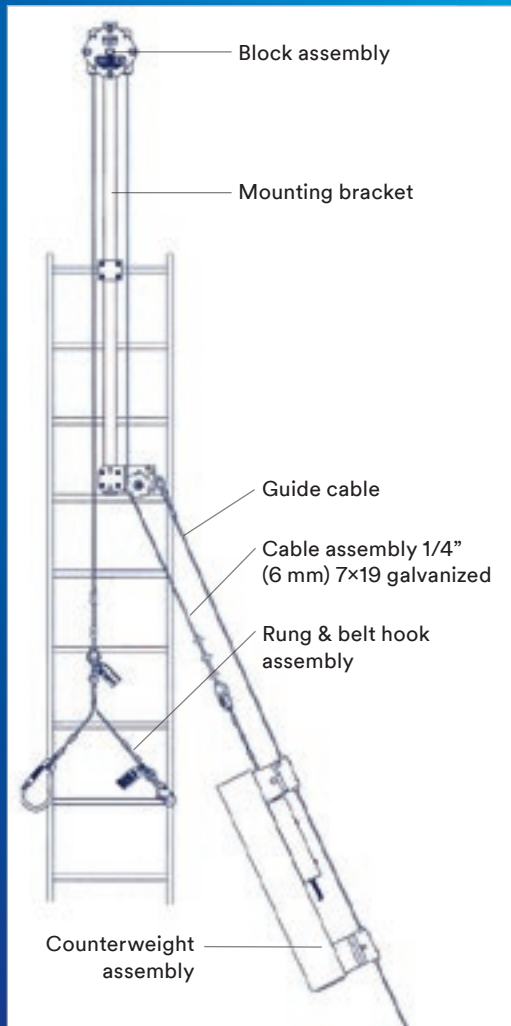

1 3511063

SSB Safety Block

Climb assist main block pulley assembly.

2 3512000

Lifeline Assembly

Galvanized 1/4 in. (6.3 cm) 7 × 19 cable assembly with rung and belt hook (last three digits in part number signify length).

3530000 Stainless Steel Lifeline Assembly

3 3511783

Mounting bracket

Attaches safety block to structure. Fits round rungs up to 3/4 in. (1.9 cm) diameter or square rungs up to 9/16 in. (1.4 cm) per side.

3511785 Mounting bracket, fits round rungs over 3/4 in. (1.9 cm) up to 1-1/2 in. (3.8 cm) diameter or square rungs over 9/16 in. and up to 1-1/2 in. (3.8 cm) per side

3511645 Rung Belt Assembly

4 3511598

Counterweight Assembly

80 lb. (36.3 kg) counterweight with integrated runaway brake system.

Rope Grabs

5000335

3M™ DBI-SALA® Lad-Saf™ Mobile Rope Grab

Mobile design automatically follows user for hands-free operation. Detachable design can be attached or removed anywhere along lifeline. Inertia and cam locking systems for safety and to prevent “panic-grab.” For use on 5/8 in. (16 mm) polyester/polypropylene rope lifeline. Use with 3 ft. (0.9 m) shock-absorbing lanyard.

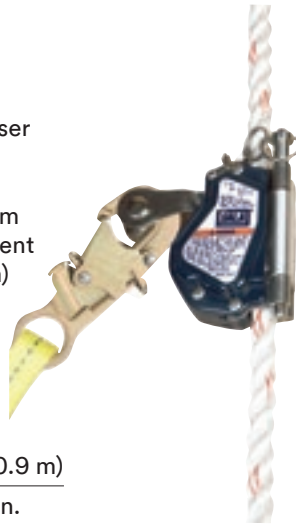

5002045 Lad-Saf Rope Grab with attached EZ-Stop™ Shock-Absorbing Lanyard x 3 ft. (0.9 m)

5001442 Lad-Saf Rope Grab for 3/4 in. (19 mm) polyester/polypropylene rope lifeline x 3 ft. (0.9 m)

1246037

EZ-Stop Rope Adjuster

Manual design allows user to fix unit in place for positioning or restraint. Cam locking system for safety. Installs at top or bottom of the lifeline. Durable and lightweight, corrosion-resistant construction. For use on 5/8 in. (16 mm) rope lifeline. Equipped with RFID.



5000338

Lad-Saf Wire Rope Grab

Manual design allows user to fix unit in place for positioning or restraint. For use in extremely abrasive or corrosive environments. For use on 3/8 in. (9.5 mm) 7 × 19 galvanized or stainless steel cable. Use with 4 ft. (1.2 m) shock-absorbing lanyard.





5000400 3M™ DBI-SALA® Rope Grab Kit

Complete rope grab system in a bag for convenient compliance and safety on the job. Kit includes:

- Mobile Rope Grab (5000335)
- Shock-Absorbing Lanyard (1246012)
- Lifeline x 50 ft. (1202794)
- Counterweight (5901583)
- Tie-Off Adapter (1003000)
- Carrying Bag (9511597)

5000401 Rope Grab Kit with 100 ft. (30 m) Lifeline (1202844) and Carrying Bag. (9503806)



Flexible Counterweight

Flexible counterweight pouch with web loop choker filled with 6 lbs.



5901583 Counterweight

5.7 lb. (2.6 kg) flexible counterweight keeps lifeline taut. Heavy-duty nylon construction. Built-in web loop for easy attachment to lifeline. Compact and portable design. Equipped with RFID.

Rope Lifelines

Blended Rope Lifeline Assemblies feature additional abrasion and UV resistance for added durability, longevity and safety. Various styles and lengths are available to suit any need.



Lifeline material	Hook style	Lifeline diameter (inch/mm)	25 ft. lifeline	30 ft. lifeline (9 m)	50 ft. lifeline (15 m)	75 ft. lifeline (22 m)	100 ft. lifeline (30 m)	150 ft. lifeline (46 m)
Polyester/ polypropylene blend	Snap hook at one end	5/8 in. (15.9 mm)	1202742	1202754	1202794	1202821	1202844	1202879
		3/4 in. (19.05 mm)	1202739	1202750	1202785	1202818	1202838	1202877
	Snap hook at both ends	5/8 in. (15.9 mm)	1202740	1202753	1202790	1202823	1202842	1202878

*Custom sizes available.



Horizontal Systems

Lifelines that work for your work site.



Flexibility. When it comes to at-height work, it's vital to your success. That's why we engineer the widest variety of horizontal lifeline (HLL) systems available—so you can maximize mobility, productivity and fall protection, no matter what the job calls for. Safety engineers and site directors can rest easy knowing all our systems meet OSHA standards, too.

How to choose a horizontal lifeline system

An HLL may appear to be a basic line strung between two anchors, but it is so much more. These systems are used to protect workers operating in the horizontal plane who may not have continuous access to suitable anchorage points, so it's critical to choose a system that has been precision engineered and rigorously tested to meet OSHA and ANSI requirements. Some other important considerations when selecting a system include:

Anchorage structure

The structure your system must attach to, such as an I-beam, rebar stud, concrete column or roof can dictate the type of specialized system required.

Portable or permanent

Temporary jobs require lightweight and easy-to-use portable systems that can be moved from one location to another. If a hazardous work area is accessed often, such as a rooftop, a permanent solution like Uniline® may be a better choice.

Clearance requirements

The distance between the work area and the next level or obstruction is often called “fall clearance,” and this is a critical factor when choosing your system. Anchorage height, type of lifeline and length are just a couple of factors that will affect the required clearance needed.

Lifeline type

Synthetic lines are extremely lightweight and compact, while galvanized or stainless steel options offer enhanced corrosion and abrasion resistance.

Number of users

Always consider the number of workers required to get the job done and choose a system that can accommodate those personnel safely.



Horizontal Systems

3M™ DBI-SALA® SecuraSpan™

Horizontal Lifeline (HLL) Systems

Extremely lightweight and portable, these systems incorporate a modular, multi-base design that accommodates a wide range of steel and concrete beams.

- Interchangeable stanchions are ideal for both steel and concrete applications.
- Extremely lightweight and portable for fast and easy setup and use.
- Single and multi-span options available for jobsite customization.
- Pass-through bracket design provides 100% continuous protection.
- Integrated Zorbit™ Energy Absorber limits forces on structure.
- Capacity of two workers per span, up to six workers for multi-span system.
- Durable and corrosion-resistant construction.
- Inquire about perpendicular applications.

Steel I-Beam applications

- Single clamp and wing nut design.
- All adjustments made from top of beam.
- Fits flanges 6 in.-12 in. wide, 2-1/4 in. thick. (15.2-30.5 cm, 5.7 cm)
- Optional bases for 18 in., 24 in. and 36 in. widths. (45.7, 60.9 and 91.4 cm)



Concrete rebar & shear stud applications

- Simply attach with torque wrench.
- Simple chain tie-back connection.
- Fits 1/2 in.-1 in. diameter (#4-#8 rebar) and 4 in.-12 in. center to center.

7400460

SecuraSpan I-Beam Horizontal Lifeline System

Complete single span system includes two Stanchions (7400047) and cable assembly with tensioner and Zorbit Energy Absorber. 60 ft. (18.3 m).

7400420 20 ft. (6.1 m) SecuraSpan I-Beam HLL System

7400430 30 ft. (9.1 m) SecuraSpan I-Beam HLL System

7400440 40 ft. (12.2 m) SecuraSpan I-Beam HLL System

7400450 50 ft. (15.2 m) SecuraSpan I-Beam HLL System



Shown with intermediate stanchion—must order separately.

7400660

SecuraSpan Rebar/Shear Stud Horizontal Lifeline System

Complete single span system includes two Stanchions (7400215) and cable assembly with tensioner and Zorbit Energy Absorber. 60 ft. (18.3 m).

7400620 20 ft. (6.1 m) SecuraSpan Rebar/Shear Stud HLL System

7400630 30 ft. (9.1 m) SecuraSpan Rebar/Shear Stud HLL System

7400640 40 ft. (12.2 m) SecuraSpan Rebar/Shear Stud HLL System

7400650 50 ft. (15.2 m) SecuraSpan Rebar/Shear Stud HLL System



Shown with intermediate stanchion—must order separately.

Concrete Loop Rebar Applications

An easy-to-install system for pre-stressed concrete beams, this attaches directly to the loop rebar. With integrated “bypass” brackets, the system can be configured to run indefinitely.

- Simple hook and loop with wing nut.
- Fits 1/2 in.-4-1/2 in. dia. (#4-#12 rebar).
- Adjusts to fit 3-1/2 in.-8 in. (8.9-20.3 cm) tall loop with 3 in. (7.6 cm) or greater spacing.

7400360

3M™ DBI-SALA® SecuraSpan™ Loop Rebar Horizontal Lifeline (HLL) System

Complete single span system includes two Stanchions (7400045) and cable assembly with tensioner and Zorbit™ Energy Absorber. 60 ft. (18.3 m).

7400320 20 ft. (6.1 m) SecuraSpan Loop Rebar HLL System

7400330 30 ft. (9.1 m) SecuraSpan Loop Rebar HLL System

7400340 40 ft. (12.2 m) SecuraSpan Loop Rebar HLL System

7400350 50 ft. (15.2 m) SecuraSpan Loop Rebar HLL System

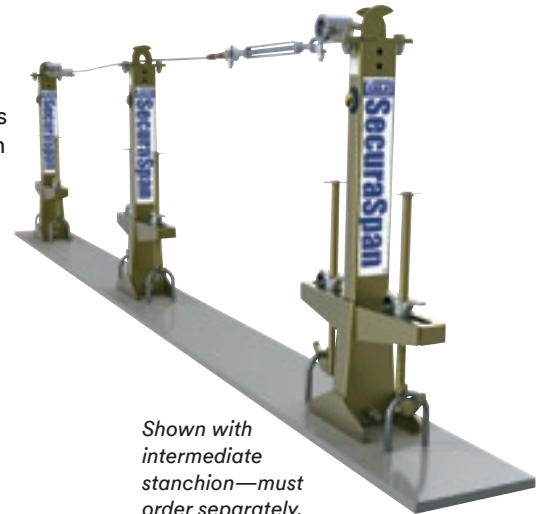

Shown with intermediate stanchion—must order separately.

SecuraSpan System Components

I-Beam System Components



7400047

Stanchion with I-Beam Base
Fits 6 in.-12 in. (15.2-30.5 cm) flange.

7400055

Stanchion with I-Beam Base
Fits 12 in.-18 in. (30.5-45.7 cm) flange.

7400056

Stanchion with I-Beam Base
Fits 18 in.-24 in. (45.7-61 cm) flange.

7400057

Stanchion with I-Beam Base
Fits 24 in.-36 in. (61-91.4 cm) flange.

7400001

I-Beam Stanchion
Fits up to 2-1/4 in. (5.72 cm) thick, 6 in.-12 in. (15.2-30.5 cm) wide.

7400052

I-Beam Base Only
Fits 6 in.-12 in. (15.2-30.5 cm) flange.

7400073

I-Beam Stanchion
Fits up to 3-3/8 in. (8.57 cm) thick, 6 in.-12 in. (15.2-30.5 cm) wide.

7400008

Intermediate Bypass Bracket Kit

Perpendicular I-Beam System Components



7400087

Stanchion with Perpendicular I-Beam Base
No tie back, fits 8 in.-14 in. (20.32-35.56 cm) flange.

7400086

Perpendicular I-Beam Base Only
Fits 8 in.-14 in. (20.32-35.56 cm) flange.

7400089

Perpendicular Pass-Through Kit

See product instruction manual for complete clearance information.

Lifeline options for all systems — Cable assembly with turnbuckle and Zorbit, lengths available in 10 ft. increments. Cable assemblies over 60 ft. (18.3 m) include two Zorbit Devices.

Rebar System Components

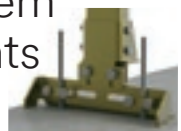

7400215

Stanchion with Rebar/Shear Stud Base
Pass-through and end anchor brackets.

7400214

Tie-Back Base and Chain Assembly

7400053

End-Anchor Retro-Fit Kit
With Rebar/Shear Stud Base, tie-back assembly, end-anchor and Pass-Through Bracket.

7400054

Intermediate Retro-Fit Kit
With Rebar/Shear Stud Base and Pass-Through Bracket.

Loop System Components



7400045

Stanchion with Loop Rebar Base and Pass-Through Bracket



7605060

3M™ DBI-SALA® EZ-Line™ Retractable Horizontal Lifeline (HLL) System

Speed up your productivity on the job. EZ-Line is an easy to use lifeline system that you can install, remove and store extremely fast. Its innovative retractable design eliminates large and bulky coils of cable that are difficult to set up, relocate and store.

- Built-in winch for fast and easy setup, use and dismantling.
- Customize length in any increment up to 60 ft. (18.25 m)
- Built-in pre-tension and impact indicators simplify setup and inspection.
- Extremely lightweight at 33% lighter than conventional systems.
- Two worker capacity.

7600002

Replacement EZ-Line Handle Assembly

See product instruction manual for complete clearance information.

Horizontal Systems

3M™ DBI-SALA® Sayflin[™] Cable Horizontal Lifeline (HLL) Systems

The Sayflin Cable System is highly portable and ideal for situations where welding, sparks or harsh environments are present, or where minimal clearance exists. Complete system includes cable lifeline assembly with wedge grip termination, tensioner and Zorbit™ Shock Absorber.

See product instruction manual for complete clearance information.



- Durable all-metal system can be left in place for long periods of time.
- Portable system can be reused over and over again.
- Cable lifeline with tensioner and shock absorber.
- Use with any 5,000 lb. (22 kN) anchorage devices.
- Capacity of two workers.
- 20 ft.-100 ft. lengths available. (6.1 m-30.5 m)

Sayflin Cable HLL Systems

20 ft. (6.1 m)	30 ft. (9.1 m)	40 ft. (12.2 m)	50 ft. (15.2 m)	60 ft. (18.3 m)	70 ft. (21.3 m)	80 ft. (24.4 m)	90 ft. (27.4 m)	100 ft. (30.5 m)
7602020	7602030	7602040	7602050	7602060	7602070	7602080	7602090	7602100

Sayflin Synthetic Horizontal Lifeline Systems

Sayflin Systems are extremely lightweight, easy to install and portable—ideal for maintenance, bridge work, construction and general industry applications, providing both safety and reliability.

- Complete system in convenient bag installs with no special tools or equipment.
- Portable system can be reused over and over again.
- Kernmantle rope lifeline with tensioner and shock absorber.
- Two tie-off adapters are included to anchor the system to a structure.
- Capacity of two workers.
- 20 ft.-100 ft. lengths available. (6.1 m-30.5 m)



See product instruction manual for complete clearance information.

Sayflin Synthetic HLL Systems

20 ft. (6.1 m)	30 ft. (9.1 m)	40 ft. (12.2 m)	50 ft. (15.2 m)	60 ft. (18.3 m)	70 ft. (21.3 m)	80 ft. (24.4 m)	90 ft. (27.4 m)	100 ft. (30.5 m)
7600502	7600503	7600504	7600505	7600506	7600507	7600508	7600509	7600510

Horizontal Systems

3M™ DBI-SALA® SecuraSpan™

Pour-in-Place Horizontal Lifeline Systems

The SecuraSpan Pour-in-Place System installs to column tops, providing an overhead tie-off point during the decking process. The stanchion slides into the embedded pour-in-place sleeve and does not require “tie-back” for fast installation.

- Lightweight and portable for fast and easy setup and use.
- Single and multi-span options with unlimited length for jobsite customization.
- Pass-through design provides 100% continuous protection.
- Integrated Zorbit™ Energy Absorber limits forces on worker and structure.
- Capacity of two workers per span, up to six workers for multi-span system.
- Durable and corrosion-resistant construction.

Complete system includes two Stanchions (7400203), and cable assembly with tensioner and Zorbit Energy Absorber.



See product instruction manual for complete clearance information.

20 ft. (6.1 m)	30 ft. (9.1 m)	40 ft. (12.2 m)	50 ft. (15.2 m)	60 ft. (18.3 m)
7400220	7400230	7400240	7400250	7400260

Pour-in-Place Accessories

7400203
Stanchion Assembly
7 ft. 6 in. tall.

7400200
Intermediate Bracket
For pour-in-place stanchion.

7400201
Concrete Sleeve
For pour-in-place stanchion.

7400211
Clamp-On Vertical Base
Zinc-plated steel construction, clamps to existing vertical steel and concrete structures.

7400218
Bolt-On Vertical Base
Zinc-plated steel construction, bolts to vertical steel and concrete structures.

7400225 Stainless steel version



7400222
Weld-On Vertical Base
Steel C-channel construction, welds to vertical steel structures.

8530267
Bolt-On Floor Base
Zinc-plated steel construction. Bolts to steel and concrete horizontal surfaces.



Horizontal Lifeline Components

- Allows use of standard 5,000 lb. (22 kN) rated anchors.
- Lightweight and compact for easy setup and use.
- Simple design makes integration into system fast and easy.

3M™ DBI-SALA® Zorbit Kits

7401013
Zorbit Energy Absorber Only

7401031
Zorbit Energy Absorber
With three shackles, bolts, nuts.

7401032
Zorbit Energy Absorber
With three shackles, bolts, nuts, turnbuckle.

7401033
Zorbit Energy Absorber
With three shackles, bolts, nuts, turnbuckle, thimbles, cable clips.

7600580
Zorbit Energy Absorber
With three shackles, bolts, nuts, turnbuckle, thimbles, cable clips with wedge grip, two O-rings.

7608008
Wedge Grip Horizontal Lifeline Termination Device



3M™ DBI-SALA® Permanent Horizontal Lifelines (HLL)

Take the guesswork and complexity out of safety. Our permanent horizontal lifeline systems aren't just remarkably easy to use—they're easy to install with the support of our network of certified installers. They provide everything from site assessment to final installation and training.

Pre-engineered or customized. Straight or curved. Flexible or rigid. Whether it's over a railcar or tanker truck, on a rooftop or in the rafters of an arena, these versatile systems provide superior continuous fall protection without conflicting with other building systems.



*Custom sizes available.



Sayflink™

Multi-Span Horizontal Lifeline Systems

The Sayflink Multi-Span System is a simple and safe permanent Horizontal Lifeline HLL system designed for “off-the-shelf” user installation. It is completely customizable, including span length, total system length and even final installation position.

- Provides 100% continuous protection for two workers.
- Unique one-piece sleeve bypasses intermediates and freely moves where you have to work.
- Customize to suit job site, 180 ft. (54.9 m) max length, 30 ft. (9.1 m) max span.
- Unique brackets can be installed above, even with, or below the user.
- System includes lifeline, intermediate bracket (one per 30 ft. span), termination hardware, tensioner and two Zorbit™ Energy Absorbers. Order sleeve and additional intermediates separately.

Horizontal Systems



Sayflink Multi-Span HLL Systems

	20 ft. (6.1 m)	40 ft. (12.2 m)	60 ft. (18.3 m)	80 ft. (24.4 m)	100 ft. (30.5 m)	120 ft. (36.6 m)	140 ft. (42.7 m)	160 ft. (48.8 m)	180 ft. (54.9 m)
Galvanized	7603020	7603040	7603060	7603080	7603100	7603120	7603140	7603160	7603180
Stainless Steel	7603073		7603076	7603079	7603070				

Sayflink Accessories

7608001

Intermediate Bracket, multi-span system.

7608002

Sayflink™ Sleeve for Sayflink Multi-Span System.



Engineered Systems

Safety systems that fit your needs.

No two job sites are the same. Each presents its own set of unique challenges, and in a rapidly evolving world, fall arrest and fall protection systems need to be adaptable to keep pace and ensure every worker's safety.

At 3M, we offer a comprehensive range of fully compliant, practical solutions for all industries. From initial installation all the way to training and use, our certified specialists provide industry-leading services throughout equipment life no matter what the job calls for.

3M™ DBI-SALA® RoofSafe™

Anchor and Cable Systems

Enhance safety and productivity on new or existing rooftops. RoofSafe Anchor and Cable Systems are horizontal lifeline systems that allow for continuous, uninterrupted access to all areas of a roof with work restraint or fall arrest protection. They can be installed on standing seam, composite and built-up roofing systems and multiple flat roofing and membrane roofing systems. For maintenance tasks in localized areas, they can also be used as a single point of anchor.

In the event of a fall, the RoofSafe Anchor breaks open, deploying the unique and patented absorbing system, which reduces the forces generated on the roof structure to less than 1,350 lbs. (6kN), the lowest of any of its kind on the market.

The ultimate in modular system design

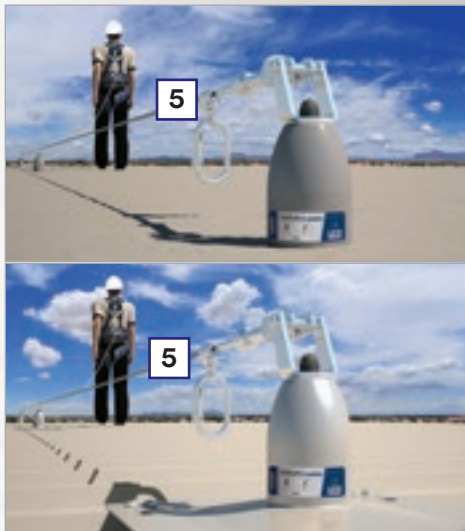

1 Lightweight durability

Constructed from high grade aluminum to reduce overall weight and shipping costs.

2 Modular construction

In the unlikely event that the anchor is deployed, the modular design allows for replacement of the top module.

3 Weatherproof design

The RoofSafe Anchor for flat roofing systems is designed for weatherproofing with built-up tar, maintaining the integrity of the building.

4 Enhanced mobility

High quality 316 stainless steel cable offers excellent freedom of movement to navigate corners and building contours.

5 Minimal penetrations

The system spans up to 40 ft. (12 m), minimizing the need for intermediate supports.

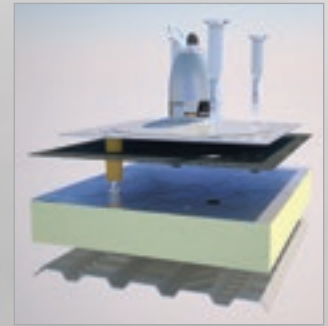

Save time and money with the toggle fixing method for flat roofing systems. It speeds up installation and reduces thermal bridging, so less heat is lost from the building.



Engineered Systems

3M™ DBI-SALA® RoofSafe™

Rail System

Great aesthetics. Uncompromising safety. The RoofSafe Rail System is a cost-effective solution for roof fall protection, roof access, and as an anchor point for suspended work positioning for external façade access, inspection and maintenance on modern building projects. It meets the requirements of both abseil and fall protection standards and can be fixed to the roof system with minor penetrations or using clamps.

- The only direct-to-roof rail system that can facilitate changes in direction and roof slopes.
- Allows multiple users to efficiently execute more complex maintenance tasks such as suspended rope access work.
- Even load distribution ensures that even if one user falls, the integrity of the roof system will not be compromised.
- Solid design ensures no deflection or unnecessary loading of anchor points during use, giving the user complete confidence even on roof pitches greater than 15 degrees.
- Four-wheel attachment carriage runs effortlessly along the extruded aluminum rail, providing user-friendly ease of use.
- Lightweight modular system comes in 10 ft. (3 m) and 20 ft. (6 m) sections that are easy to transport and handle on-site.



Top quality



3M™ DBI-SALA® Uni 8™

Cable System

Enhance modern building projects, refurbishments or industrial safety applications. This high quality fall restraint system provides both excellent value and functionality through its free-flowing bypass capability. Fit it to steel beams, concrete, brickwork and a variety of roof constructions using our RoofSafe™ Anchors. It can also support multiple workers for both fall arrest and fall restraint work applications.

1

1 Durable cable

The single 0.31 in. (8 mm) cable provides a discreet and unobtrusive solution to fall protection. Electro-polished stainless steel (316) components provide long-term corrosion resistance.

2 Long spans

The Uni 8 System can span up to 40 ft. (12 m) between support brackets. Supports two users, up to 310 lbs. each, per span.



- A broad range of mounting bracket options allows navigation of corners.
- Optional travelers available to be used on either side of the line without removing and reattaching.
- In-line energy absorbers reduce load transfer to the structure in the event of a fall.
- Minimal moving parts and high grade materials ensure long life expectancy and low cost of ownership, adding up to a sound investment.



Engineered Systems



3M™ DBI-SALA® Uni 8™ Overhead Traveler

Move safely. Move freely. Maximize productivity. It's all made possible by the Uni 8 Overhead Traveler. It passes freely over intermediate brackets, ensuring complete freedom of travel and movement for the user.

1 Sealed bearings

Sealed bearings in the carriage wheels of the Uni 8 Overhead Traveler reduce the need for maintenance.

2 Long-term corrosion resistance

Electro-polished stainless steel (316) components provide long-term corrosion resistance.

- High tensioned stainless steel cable supports heavy fall arrest devices when required and reduces cable deflections.
- In-line energy absorbers reduce load transfer to the structure in the event of a fall.
- Available as a single- or multi-span system for distances up to 100 ft. (30 m). Supports two users, up to 310 lbs. each, per span.
- Strong intermediate cable supports allow the system to span greater distances for long bay work areas and permit free passage of the Uni 8 Overhead Traveler.



3M™ DBI-SALA® UniRail™

Horizontal System

Simplicity and safety. Two qualities that should go hand-in-hand. That's why we've engineered the UniRail Horizontal System to protect workers from fall hazards with a simple, continuous and functional anchorage system.

- Fits a wide range of structures, supporting both fall arrest and fall restraint applications. With spans up to 20 ft. (6 m), it supports two users, up to 310 lbs. each, per span.
- High-grade aluminum alloy and 316 stainless steel components help system withstand harsh environments.
- The main rail is designed to resist thermal expansion and contraction, which would otherwise cause the rail to buckle.
- Modular design makes it easy to install and specify.



Engineered Systems





Anchorage Connectors

The more
you trust
an anchor,
the more
you enjoy
the view.



The higher you climb, the greater the scenery. And the security you feel with a 3M™ DBI-SALA® Anchorage Connector only makes it better.

That's because each of our connectors has been rigorously tested to meet or exceed OSHA and ANSI standards. On top of that, we offer the most complete line of anchorage connectors, so you can work with total peace of mind that you've got the best gear available for the job.

Your choice of anchor depends on the type of work being done. Anchorages are sold by what they connect to (general/all-purpose, steel, concrete, roof, mining or specialty), whether they are fixed or mobile, and whether they are permanent or portable. They all must provide a secure point of attachment for a complete personal fall arrest system, and must be capable of supporting a load of 5,000 lbs. (22 kN), or of meeting OSHA's criteria of a 2-to-1 safety factor.



Anchorage Connectors

3M™ DBI-SALA®

General Anchorage Connectors

Extremely versatile anchors are simply choked-off to the anchorage structure, to provide a fast and safe 5,000 lb. (22 kN) tie-off point for your personal fall protection system.

1003000

Web Tie-Off Adapter

Pass-through design. 1-3/4 in. polyester strength member with 3 in. wide polyester wear pad x 3 ft. (0.9 m.)



1003006 Web Tie-Off Adapter, pass-through type x 6 ft. (1.8 m)

1002103 Adjustable Web Tie-Off Adapter, pass-through type x 3 ft. (0.9 m)

1002106 Adjustable Web Tie-Off Adapter, pass-through type x 6 ft. (1.8 m)

1002010 Web Tie-Off Adapter, pass-through type x 10 ft. (3.0 m)

5900550

Cable Tie-Off Adapter

Pass-through design. 7 in. x 19-3/8 in. (9.5 mm) stainless steel cable with O-rings x 4 ft. (1.2 m).



5900551 Cable Tie-Off Adapter, pass-through type x 6 ft. (1.8 m)

5900552 Cable Tie-Off Adapter, pass-through type x 10 ft. (3.0 m)

1002202

Tie-Off Adapter for Hot Work Use

Reinforced with Kevlar® fiber webbing; ideal for high heat environments, pass-through type with 1-3/4 in. polyester strength member x 6 ft. (1.8 m).



1002200 Tie-Off Adapter, with Kevlar® fiber, pass-through type x 3 ft. (0.9 m)

1002201 Tie-Off Adapter, with Kevlar® fiber, pass-through type x 4 ft. (1.2 m)

1201390

Web Scaffold Choker

Choker style attaches to 3 in. (76 mm) diameter anchorage. 1 in. (25 mm) polyester strength member x 17 in. (43 cm).



1201391 Web Scaffold Choker x 24 in. (61 cm)

1201421 Web Scaffold Choker with coated hardware

1002106 Adjustable Web Tie-Off Adapter, pass-through type x 6 ft. (1.8 m)

Saflok™ Carabiners can be found on page 75.



3M™ DBI-SALA® Saflok™

Mining Anchors

Maximize fall protection for mine workers with our Saflok Mining Anchors. These ANSI and OSHA-certified anchors are designed for use with friction rock bolts in a variety of different mining applications.

The Hybrid Mining Swivel Anchor is intended to stay in one spot, while the Mining Bolt Anchor with Swiveling O-Ring offers the flexibility to move from location to location within the mine. Both are durable, lightweight and easy to install and remove, and can be used with many existing 39 mm or 47 mm friction rock bolts.

Saflok Mining Bolt Anchor with Swiveling O-Ring

The Mining Bolt Anchor with Swiveling O-Ring is an anchorage connector for fall arrest, restraint, work positioning, personnel riding and rescue systems. The anchor's end termination expands two wedges to secure the anchor in a 39 mm or 47 mm friction rock bolt—a feature exclusive to 3M Fall Protection.

2100154

Mining Bolt Anchor with Swiveling O-Ring (47 mm)

Specifications:

- Swivel ring: forged steel.
- End termination: stainless steel.
- Main support cable: aircraft cable.
- Stop sleeve: stainless steel.
- Trigger: aluminum.
- Spring: zinc-plated steel.
- Product variance and strengths: 5,000 lbs. (22 kN)
- Certifications: ANSI Z359.1-2007, ANSI Z359.7-2011, OSHA 1926.502

2100153 Mining Bolt Anchor with Swiveling O-Ring (39 mm)



18.5" (49.99 cm)



Saflok Hybrid Mining Swivel Anchor

The Hybrid Mining Swivel Anchor is an anchorage connector for fall arrest, restraint, work positioning, rope access and rescue systems. Rotation of the bolt moves the end termination out or in to expand or contract two wedges within a 39 mm or 47 mm friction rock bolt. When the wedges are fully contracted, the anchor can be removed from the friction rock bolt for reuse. The swivel ring is the connection point and can swivel for use.

2100172

Stainless Steel Hybrid Mining Swivel Anchor (47 mm)

Specifications:

- Swivel ring: forged steel/stainless steel.
- End termination: stainless steel.
- Cable: aircraft cable.
- Compression bushing: polyethylene.
- Retaining bushing: zinc-plated steel/stainless steel.
- Bolt: zinc-plated steel/stainless steel.
- Wedges: stainless steel.
- Sleeves: zinc-plated steel/stainless steel.
- Product variance and strengths: 5,000 lbs. (22 kN)
- Certifications: ANSI Z359.1-2007, ANSI Z359.7-2011, OSHA 1926.502

2100155 Hybrid Mining Swivel Anchor (39 mm)

2100156 Hybrid Mining Swivel Anchor (47 mm)

2100171 Stainless Steel Hybrid Mining Swivel anchor (39 mm)

11.5" (23.3 cm)



Anchorage Connectors

3M™ DBI-SALA®

Steel Anchorage Connectors

Extremely versatile anchors for steel that are lightweight and compact, providing an easy to install and safe 5,000 lb. (22 kN) tie-off point for your personal fall protection system.

2104700

Glyder™ 2 Sliding Beam Anchor

Provides complete horizontal mobility on I-beams, overhead attachments or at your feet (use with Force2™ Shock-Absorbing Lanyard when used at your feet).

- Wear pads eliminate metal-to-metal contact, for smooth operation.
- Integrated ratcheting adjustment system for easy installation.
- Dual beam grip adjustment prevents twisting and turning.
- Extremely lightweight at only 3.7 lbs. (1.66 kg).
- User capacity of 420 lbs. (189 kg).
- Fits flange 3-1/2 in.-14 in. wide and up to 1-1/4 in. thick.



2110941

Glyder Sliding Beam Anchor

The original Glyder has most of the features of Glyder 2, except the adjustment system is a detent pin type and fits larger beam sizes. Fits flange 6 in.-18 in. wide and up to 2-1/2 in. thick.



2108406

Fixed Beam Anchor

It installs in seconds to the beam structure in any orientation, with final tightening using a built-in adjustment handle. Ideal as a single-person anchor point or as end-anchors for a Sayflin™ Horizontal Lifeline System. Fits up to 1-1/2 in. thick beam flange, 2-1/2 in.-12 in. wide.

2108407 Fixed Beam Anchor, fits up to 1-1/2 in. thick x 2-1/2 in.-18 in. wide beam flange

2108408 Fixed Beam Anchor, fits up to 1-1/2 in. thick x 2-1/2 in.-24 in. wide beam flange

2108410 Fixed Beam Anchor, fits up to 1/2 in.-2-1/2 in. thick x 12 in.-36 in. wide beam flange



2103143

3M™ DBI-SALA® Trolley for I-Beam

The trolley is for use with self-retracting lifelines on horizontal beams and has been engineered for ease-of-use and superior performance. It glides effortlessly along the beam and provides horizontal mobility.

- Attachable anywhere along beam, including midpoint.
- Non-corrosive double-shielded wheel bearings are maintenance-free.
- Trolley guards protect the wheels from damage and keep beam clear of debris.
- Fits 3 in.-8 in. flange width and thickness up to 11/16 in.

2103147 Trolley for I-Beam, all stainless steel, fits 3 in.-8 in. flange width and thickness up to 11/16 in.

8800023

Tandem Pulley

For 3/8 in.-1/2 in. rope or cable.

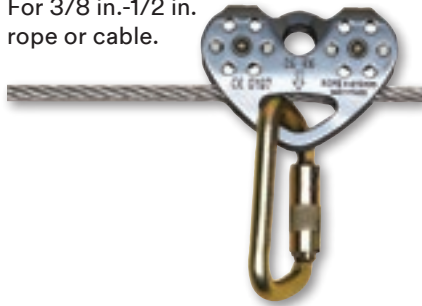

2104550

Steel Plate Anchor

This plate anchor offers a compact, reliable attachment to 3/8 in.-1 in. thick plate steel for connecting your lanyard, vertical lifeline system or self-retracting lifeline.

- Easy to use set-screw design ensures positive and safe connection.
- Complete with integral D-ring tie-off point.
- Durable, corrosion-resistant zinc-plated steel construction.



2101630

D-Ring Anchorage Plate

The D-Ring Anchorage Plate can be bolted or welded to a structure, offering a compact, reliable connection point for your fall protection system.

- Two 1/2 in. diameter attachment holes.
- Cadmium-plated steel D-ring.
- 304 stainless steel anchorage plate.
- Plate size: 1/4 in. x 2 in. x 4-1/2 in.

2101634 D-Ring Anchorage Plate with cadmium-plated steel D-ring, raw steel anchorage plate

2101636 D-Ring Anchorage Plate with 304 stainless steel D-ring and anchorage plate

2101638 D-Ring Anchorage Plate with 316 stainless steel D-ring and anchorage plate



Anchorage Connectors

3M™ DBI-SALA®

Concrete Anchorage Connectors

Extremely versatile anchors for concrete that are lightweight and compact, providing an easy-to-install and safe 5,000 lb. (22 kN) tie-off point for your personal fall protection system.

2100085

Saflok™ Concrete Wedge Anchor

Portable and reusable concrete anchor installs quickly and easily using standard concrete tools, providing a fast and safe tie-off point.

- Exclusive quick-release button for fast removal.
- Unique forged connection ring provides a compatible tie-off point.
- Shielded load cable and chock release cables.
- Exclusive pivoting easy-grip handle.



2100101

Saflok Toggle Anchor

Portable and reusable anchor installs in just seconds to concrete or steel for horizontal, vertical, or overhead applications, providing a compatible, fast and safe tie-off point.

- Activator cable provides toggle mode selection (Open or Lock).
- Toggle position indicator visually notifies user if locked or unlocked.
- Swiveling D-ring provides a compatible tie-off point.

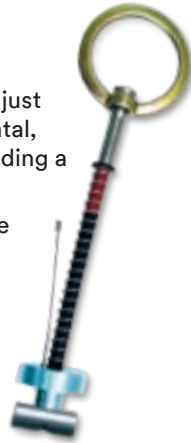

2100050

Concrete Anchor Strap

Our disposable concrete anchor strap provides a temporary anchorage on concrete forms and is extremely easy to install and use.

- Loop slips over rebar, then concrete is poured over. When no longer needed, simply cut strap and discard.
- Durable 1-3/4 in. polyester construction x 3-1/2 ft. (1 m). Full length wear pad for abrasion resistance.
- D-ring provides compatible tie-off point.



2100053 Concrete Anchor Strap with D-ring, 48 in. (1.2 m)

2100061 Concrete Anchor Strap, no D-ring, 3-1/2 ft. (1 m)

2104560

Concrete D-Ring Anchor

A simple, versatile and safe concrete anchor solution for use in temporary or permanent applications, providing a safe tie-off point.

- Reusable D-ring assembly.
- Rugged design for harsh environments.
- Safe “hook-up” indicator notifies user of proper installation.
- Install into 11/16 in., 18 mm or 3/4 in. holes—only standard drill bits needed.



2104561 Concrete D-Ring Anchor with 5 additional bolts

2104562 Concrete D-Ring Anchor with 11 additional bolts

2100066 10-pack of Replacement Bolts for Concrete D-Ring Anchor

2101004

Concrete Detent Anchor

A versatile, simple and safe concrete anchor utilizing pre-installed sockets, enabling the user to connect and disconnect from the anchorage by simply pressing a button.

- Use for floor, wall or ceiling type applications.
- Provides convenient tie-off points wherever needed.
- Push-button operation for fast and easy operation.
- Socket includes cover cap to hide recess, blending into the decor.



2101000 Concrete Detent Socket and cap only

2101002 Concrete Detent Pin only

2100152 Concrete Pour-in-Place Anchor

2100169 Pour-in-Place Detent Anchor Assembly with detent pin and socket





2105500

3M™ DBI-SALA® Concrete Leading-Edge Tripod

This anchor provides workers with a quick, easy and safe anchorage point during pre-cast concrete work.

- For use with 3504500 Ultra-Lok™ Leading-Edge SRL (see page 97).
- Swivels 360 degrees offering complete freedom of movement.
- Also use as end anchors for a temporary horizontal lifeline.
- Built-in ratchet securing system—no special tools required.

8523178

Concrete Parapet Anchor

Portable anchorage connector developed for use in locations where a low parapet wall provides an anchor site for a shock-absorbing lanyard or self-retracting lifeline.

- Non-penetrating design eliminates site damage.
- Adjustment range 1 in.-14.5 in. wide.
- No tools required for installation.

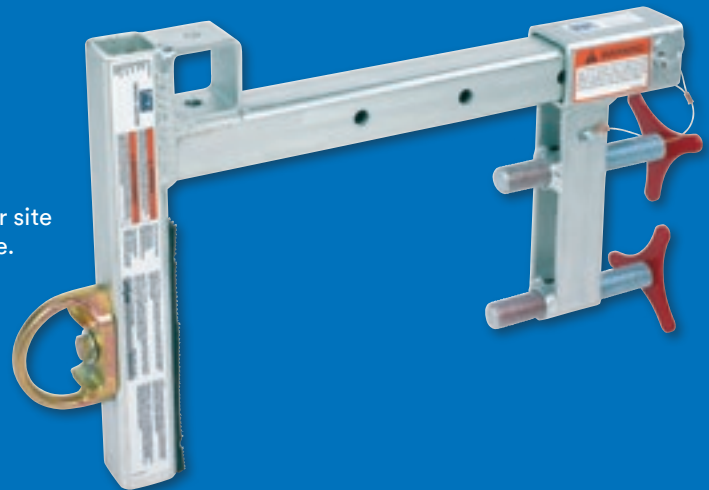

1231305

Saflok™ Max Web Anchor

Anchor can be directly connected to many concrete wall forms to provide a tie-off point for your system. Web anchor strap with large opening, Saflok Max Hook at one end, D-ring at other x 1.5 ft. (45 cm)



Anchorage Connectors

3M™ DBI-SALA®

Roof Anchorage Connectors

Wood or steel. Residential or commercial. Flat or sloped. No matter what type of roof you're working on, your fall protection system needs specialized components to keep you safe without causing damage to the structure. Our easy-to-use kits and anchorage devices provide the perfect solution and meet the latest OSHA and ANSI standards.

2104168

Roofer's Fall Protection Kit

Complete fall protection system in a bag for convenient compliance and safety on the job.

Kit includes:

- Reusable Roof Anchor (2103673)
- Full-Body Harness (1103513)
- Rope Adjuster with Shock-Absorbing Lanyard (1246037)
- Lifeline x 50 ft. (1202794)
- Counterweight (5901583)
- Carrying Bag (9511597)

2104169 Roofer's Fall Protection Kit with Roof Anchor (2103676)



7611907

Two-Person Roofer's Fall Protection Kit

Complete fall protection system in a bag for convenient compliance and safety on the job. Kit includes:

- Two Delta™ Full-Body Harnesses (1103513)
- 50 ft. Sayline™ HLL System with two 2103673 Reusable Roof Anchors (7600511)
- Two Rope Adjusters with Shock-Absorbing Lanyards (1246037)
- Two 50 ft. Lifelines (1202794)
- Two Counterweights (5901583)
- Two Carrying Bags (9511597/9506162)

7611904 One-person 50 ft. Sayline HLL System, Rope Adjuster with Shock-Absorbing Lanyard, two Reusable Roof Anchors and Carrying Bag

7600511 50 ft. Sayline HLL System with two Reusable Roof Anchors and Bag only—for two people



2103673

Portable Reusable Roof Anchor

For use on flat or sloped wood roofs. Installs with twelve 16D nails or six 1/4 in. x 2-1/2 in. bolts. Can be used with horizontal lifeline systems for added versatility.



2104816

Drop-Through Anchor

10 ft. (3.0 m) drop-through anchor with swiveling D-ring for concrete and steel, fits 1-1/2 in. to 1-3/4 in. dia. hole (38.1 to 44.5 mm) with a minimum thickness of 4 in. (101.6 mm).



2103677

Portable Reusable Roof Anchor

For use on flat or sloped wood roofs. Installs with three grade 5, 5/16 in. x 3 in. lag screws. Compact design is extremely easy to transport, install, dismantle and store.



2104541

Detachable Roof Anchor with flashing

Removable D-ring assembly allows you to leave behind the clamp assembly and then shingle over it, reusing the D-ring at another location. Fits 2 x 6 to 2 x 8 roof truss, joist or rafter.



2104542

Detachable Roof Anchor

Fits 2 x 10 to 2 x 12.

2104540 Detachable Roof Anchor, fits 2 x 4

2103670

Permanent Roof Anchor with flashing and cap

Clamps onto roof truss up to 2 x 8 size and comes complete with flashing to prevent leakage and D-ring cap for aesthetics. Provides fall protection during initial construction as well as for future homeowner.



2103671 Permanent Roof Anchor with flashing and cap, fits 2 x 10 to 2 x 12

2103675

Portable/Reusable Standing Seam Roof Anchor

Attaches to sloped or flat structural standing seam roofs. Telescoping adjustment fits 24 in., 30 in., 32 in. and 36 in. seam spacing. Swivels 360 degrees and designed for use with Ultra-Lok™ Leading Edge SRL (order SRL separately).



2100185

Freestanding Counterweight Anchor

Freestanding system is easily placed on top of the roof surface to provide a tie-off point for one worker. A swiveling D-ring integrated into the assembly allows the worker to move freely 360 degrees. Lifting kit also available.



7200439 45 lb. (20 kg)

Single Replacement Counterweight

2104190 Lifting Kit Assembly

2100133

Roof Top Anchor with extra large baseplate for metal, concrete and wood

All assembled kits include an extra large baseplate and an integrated anchorage point for one user fall arrest. Permanent anchor assembly is designed for 26 gauge or thicker corrugated metal decking with ribs 10 in. (254 mm) to 20 in. (508 mm) apart, 5/8 in. (16 mm) CDX plywood or concrete. Minimum concrete compressive strength of 3,000 PSI (21 MPa). Minimum thickness of 6-1/2 in. (16.5 cm) for chemical anchors. Minimum thickness of 5-1/2 in. (14 cm) for mechanical anchors.



Anchorage Connectors

2100138

3M™ DBI-SALA® Standing Seam Roof Anchor
Kit includes a baseplate and an integrated anchorage point for one user fall arrest. Permanent anchor assembly designed specifically for standing seam roofs.

7241204 “Z” Maxi Clamp Kit, 4-pack, for bulb-type standing seams

7241206 “E” Maxi Clamp Kit, 4-pack, for double fold standing seams

7241208 “U” Maxi Clamp Kit, 4-pack, for single fold standing seams



A supplement of fasteners, clamps and rivets is available for installation on a variety of roofing profiles.

2100139

Roof Top Anchor for membrane type roofs

All assembled kits include a baseplate and an integrated anchorage point for one user fall arrest. Permanent anchor assembly fastens through the membrane—up to 12 in. (300 mm)—insulation and into the metal sheathing, wood sheathing or concrete.



2100140 Anchor for PVC Roofs

2100142 Anchor for Bitumen Roofs

7241182 Toggle Bolt Kit, 6 in. (150 mm), 4-pack

7241183 Toggle Bolt Kit, 12 in. (300 mm), 4-pack

2105683

Reusable Swiveling Roof Anchor

Provides 360 degrees of mobility and protection on sloped or flat wood and metal decking. For use with 30 ft. (3504430) or 50 ft. (3504450) Ultra-Lok SRL (order separately). May also be used as end-anchors for horizontal lifeline system.



3505694

Reusable Swiveling Roof Anchor

Provides 360 degrees of mobility and protection on sloped wood roofs. Includes 30 ft. (3504430B) Ultra-Lok™ SRL.

3505695 Reusable Swiveling Roof Anchor with 50 ft. (3504450) Ultra-Lok SRL

2105682 Reusable Swiveling Roof Anchor only



2103690

3-Man Reusable Swiveling Roof Anchor

- Installs to sloped wood roof structures.
- Fast and easy screw installation; Fastener kit included.
- Three built-in swiveling D-ring anchor points.
- Durable and corrosion resistant construction.
- Compact and lightweight design.
- Adjustable feet and legs.
- 54 in. (137.2 cm) height when full extended.
- Portable and reusable.



3M™ DBI-SALA® Saflok™

Wood Pole and Steel Structure Anchor Systems

2104801

Provides wood pole climber with 100% fall protection, allowing installation of anchor and lifeline to top of pole from the ground. Quickly and safely climb prior to connecting work positioning system.



- Compatible with most hot stick poles.
- Includes anchor tube with installation/removal tool.
- 80 ft. (24 m), 5/8 in. (16 mm) dielectric rope and two carabiners.
- Rope grab with shock-absorbing lanyard.
- Chain tensioner, web loop and carrying bag.

2104810 Saflok Steel Structure Fall Arrest System with anchor tube, installation/removal tool, 80 ft. (24 m), 5/8 in. (16 mm) high dielectric rope, carabiner, rope grab with shock-absorbing lanyard, rescue loop sling and carrying bag

2104800 Saflok Pole Anchor System with anchor tube, 80 ft. (24 m), 5/8 in. (16 mm) high dielectric rope, installation/removal tool, one carabiner, rope grab with integrated shock-absorbing lanyard & carrying bag

3M™ DBI-SALA®

Remote Anchoring System



2104527

Provides a safe means to anchor a fall protection device to an overhead location beyond normal reach.

- Pole adjusts from 6 ft.-12 ft. (1.8 m-3.6 m)
- Tie-off adapter tool for installation of anchorage device.
- Hook attachment tool for installation of 3,600 lb. gated snap hooks.
- Tie-off adapter x 3 ft. (0.9 m) and carrying bag.

2104528 System with 8 ft.-16 ft. (2.4 m-4.8 m) adjustable pole

2104529 Snap Hook Connector Tool for 3,600 lb. gated hooks

2104530 System, 6 ft.-12 ft. (1.8 m-3.6 m) adjustable pole with original and 3,600 lb. gated hook tools

2104531 System, 8 ft.-16 ft. (2.4 m-4.8 m) adjustable pole with original and 3,600 lb. gated hook tools

2100090

Perimeter Limiter Leading Edge Anchor

Freestanding, non-penetrating anchor is ideal for concrete decking construction and provides overhead anchorages for up to two users.

- Large foam filled trailer tires won't go flat and provide easy movement.
- Rotating 7.5 ft (2.3 m) mast and anchorage arm for added freedom of movement.
- Pre-drilled holes for accessory rescue winches or job site boxes.
- Additional weights and taller mast can be added for job site flexibility.

2100091 9-1/2 ft. Mast for perimeter limiter



2100080

Door/Window Jamb Anchor

Non-penetrating anchor is lightweight and portable, requiring no tools for attachment. Adjustable opening ranging from 21.5 in.-51.5 in. (54.6 cm-130.8 cm). Rated for 3,600 lb. (16 kN)



3M™ DBI-SALA® Mobi-Lok™ Self-Contained Vacuum Anchor System

Whether you need a broken strobe replaced atop a jumbo jetliner, or it's simply time for routine maintenance, your workers should only have to focus on one thing: getting the job done right. The Mobi-Lok Self-Contained Vacuum Anchor (SCVA) system allows your workers to conveniently anchor to virtually any smooth, non-porous surface—enabling them to work where they need to without compromising their fall protection safety.

1 Audio alarm warning system

2 Convenient carrying handle

3 Secure anchor point

4 Aviation rated electronics

Intrinsically safe

5 Vacuum level indicator

6 Shop air quick connect

7 Surface friendly

Skydrol-resistant, EPDM rubber seal (Aviation model)

8 Fits small fuselage

Pad conforms to fuselage as small as 6 ft. in diameter

9 Optional cylinder attachment

Increases portability



Freedom to work.

A worker connected to a Mobi-Lok System can move about freely and confidently without compromising safety. It's engineered and rated for fall arrest applications (up to 310 lbs. max), but it can also be used in a fall restraint application to maximize versatility.

Connections in seconds.

The Mobi-Lok System eliminates the need to drill or weld to create a secure anchor point. Instead, your crew can get connected with minimal effort in just a few seconds—improving productivity and reducing downtime.

Completely mobile.

At just 19.9 lbs (9.0 kg), the Mobi-Lok System is both easy to use and easy to transport between the tarmac and the holding area.

Globally compliant.

Every Mobi-Lok model is OSHA, CE and AS/NZS compliant and is independently tested and approved for fall arrest applications when operated according to provided instructions.

Comprehensive backup system.

To enhance worker safety, the Mobi-Lok System features a comprehensive backup system. If the compressed air source is lost, a persistent audio alarm and vacuum level indicator alert the worker while check valves maintain the vacuum seal.

3M™ DBI-SALA® Mobi-Lok™ Self-Contained Vacuum Anchor Systems

Horizontal lifeline-ready

Two Mobi-Lok units can be connected using a horizontal lifeline (HLL) to create a continuous anchor point for up to two people.



Product specifications

	Shop air powered	Shop air/gas powered
Main support assembly	Anodized aluminum	
Vacuum seal pad material - aviation	EPDM	
Vacuum seal pad material - general industry	Polybutadiene	
Electronics	4 AA lithium batteries	
Shop air requirements	80 psi-150 psi	
Compressed gas bottle requirements	—	3,000 psi, 48 in ³
Dimensions	22 in. x 22 in. x 6 in. (55 cm x 55 cm x 15 cm)	
System weight	17.4 lbs. (7.8 kg)	19.9 lbs. (9.0 kg)
Capacity	310 lbs. (140 kg); One person	
Surface temperature range	-20°F to 140°F (-29°C to 60°C)	
Vacuum anchor static capacity	3,375 lbs. (15 kN)	

Product selection guide

Components	Aviation	General industry
Mobi-Lok SCVA assembly (shop air powered)	2200107	2200094
Mobi-Lok SCVA assembly with on board bottle attachment (shop air or gas powered)	2200108	2200095
Secondary pad assembly (optional)	2200109	2200096
Secondary pad hose (optional) – 50 ft. (15 m)	2200130	
Aviation HLL kit (includes secondary pad, 40 ft. HLL, and secondary pad 50 ft. hose)	2200123	—
80 ft. (24 m) 2-person HLL system	2200401	—
100 ft. (30 m) 4-person HLL system	2200180	—
150 ft. (45 m) 4-person HLL system	2200181	—
Compressed gas cylinder (bottle sold separately)	2200078	
Aviation Kit (includes Mobi-Lok SCVA assembly and bottle)	2200122	—
Carry case included		

System selection guide

	Aviation	General industry
Standard unit for fall arrest/restraint	2200108 or 2200107	2200095 or 2200094
40 ft. (12 m) HLL system	2200108+2200123 or 2200107+2200123	2200095+2200124 or 2200094+2200124
80 ft. (24 m) HLL system	2200108*2+2200401+2200109+2200130 or 2200107*2+2200401+2200109+2200130	2200095*2+2200401+2200096+2200130 or 2200094*2+2200401+2200096+2200130

Recommended lanyard is 1246170



Flexiguard™ Solutions

Unique application? Unique solutions.

Maximum safety. Peace of mind. Flexiguard is designed to meet the requirements of your specific application.

Durable

- Powder-coated, anodized high strength alloy.
- Specifically engineered for extra tall and wide applications.
- Enclosed rail to help keep debris out (weather elements).
- 100% fall arrest rated tie-off from the ground up.
- SAE J429 Grade 8 hardware with zinc yellow Chromate-plated finish.

Portable

- Lightweight design—easily moved by minimal personnel.
- Most allow for positioning by a forklift or other service vehicle.
- Heavy-duty stabilization for use on uneven ground.

Versatile

- Indoor and outdoor use.
- Multiple overhead anchor points on systems that are designed for multiple users.
- Provides a large, safe working area — working radius from rail is 6 ft. or 30 degrees.
- Rigid anchor points have no deflection or sag, reducing fall clearance requirements.
- Systems can be permanently mounted (where applicable).
- Flexiguard custom solutions meet the needs of specific and challenging work environments.









We're helping make worker safety a simple guarantee. From our internal ISO-certified lab and certified technicians, to our industry-leading installation, training services and annual inspections, we've got you covered throughout equipment life.

Our engineering and manufacturing team in Red Wing, MN tests and certifies all products to meet and often exceed the latest regulatory standards, including compliance with ANSI, CE and OSHA standards.



Ideal applications include:

TRANSPORT	CONSTRUCTION	UTILITIES
		
OIL AND GAS	MINING	WIND ENERGY
		

Flexiguard™ Solutions

3M™ DBI-SALA® SafRig™ System

Maximize safety while maintaining portability. The Flexiguard SafRig Fall Protection System is ideal for applications that require a large work area in a limited space. The smaller frame allows trucks to be parked side-by-side during use but does not require the weight of the vehicle as the anchoring force. The 360 degree rotational boom provides a 5 ft. (1.5 m) working offset, and has the capacity to provide fall protection or a rescue system for one person. Forklift pockets simplify moving the system around a job site. Depending on the type of base, these systems are ANSI, OSHA and CE compliant.

SafRig Systems

- Periscoping rotation handle included for turning system into working position.
- Counterweight base solutions available with or without concrete.
- Each type of system comes rescue-ready with inclusion of pulleys and the winch mounting plate.

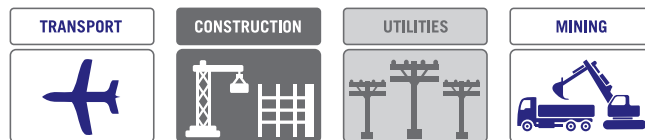

SafRig with Outrigger Base

Base	Anchor height	Offset	PPE	# of Users	Part #
15 ft. (4.56 m) x 15 ft. (4.56 m)	20 ft. (6.1 m)	5 ft. 10 in. (5.36 m)	not included	1	8530607
15 ft. (4.56 m) x 15 ft. (4.56 m)	20 ft. (6.1 m)	5 ft. 10 in. (5.36 m)	included*	1	8530579

SafRig with Counterweight Base and PPE Kit

Base	Anchor height	Offset	PPE	Concrete	# of Users	Part #
4 ft. 6 in. (1.4 m)	20 ft. (6.1 m)	5 ft. 9 in. (5.36 m)	not included	with	1	8530606
4 ft. 6 in. (1.4 m)	20 ft. (6.1 m)	5 ft. 9 in. (5.36 m)	not included	without	1	8530619
4 ft. 6 in. (1.4 m)	20 ft. (6.1 m)	5 ft. 9 in. (5.36 m)	included	with	1	8530595
4 ft. 6 in. (1.4 m)	20 ft. (6.1 m)	5 ft. 9 in. (5.36 m)	included	without	1	8530620

*PPE Kit includes: 20 ft. (6.1 m) Ultra-Lok™ Self-Retracting Lifeline with Saflok™ Carabiner and 25 ft. (7.6 m) tagline.



3M™ DBI-SALA® Counterweight Jib

Indoor and outdoor maintenance is simpler and safer with our Counterweight Jib System. Featuring a 360 degree rotating jib, this portable solution provides optimal mobility and fall protection safety for one person. Forklift pockets are strategically located on all four sides of the base to ensure ease of mobility and placement between job sites. The base also contains four heavy-duty lifting rings for transport by a crane. These systems are ANSI and OSHA compliant.

Counterweight Jib Systems

- Periscoping rotation handles included for turning system into working position.
- Counterweight base solutions available with or without concrete.
- Installed rail with trolley.

Anchor height	Offset	Concrete	# of Users	Part #
16.75 ft. (5.1 m)	8 ft. (2.4 m)	without	1	8517750
16.75 ft. (5.1 m)	8 ft. (2.4 m)	with	1	8517751
20.67 ft. (6.3 m)	8 ft. (2.4 m)	without	1	8517752
20.67 ft. (6.3 m)	8 ft. (2.4 m)	with	1	8517753
23.67 ft. (7.2 m)	8 ft. (2.4 m)	without	1	8517754
23.67 ft. (7.2 m)	8 ft. (2.4 m)	with	1	8517755

No-Base Systems

- Attach to supporting, fixed structure (e.g. on I-Beam) on the job site.
- Mounting clamps, plates and hardware included with systems.
- System rotates 180 degrees and locks every 7.5 degrees.
- Installed rail with trolley.

Boom height	Offset	# of Users	Part #
TBD by end user	20 ft. (6.1 m)	1	8530433

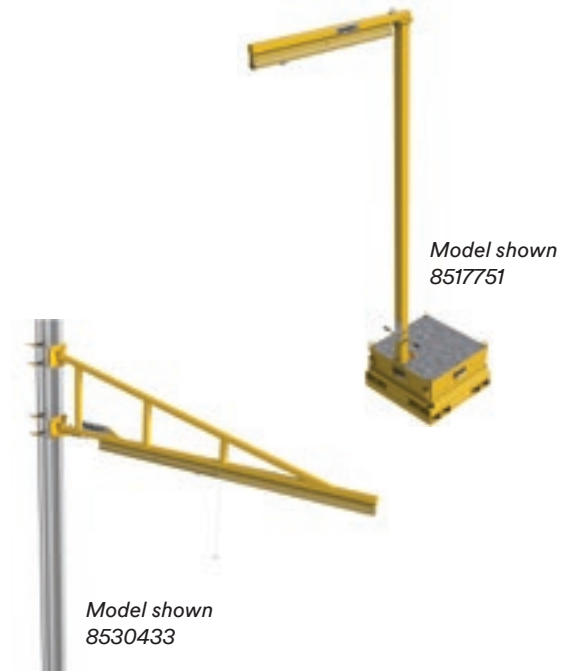
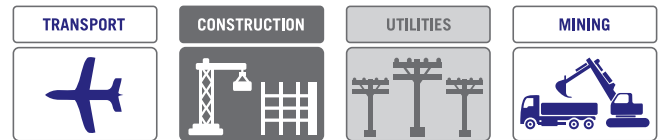

Flexiguard™ Solutions

Flexiguard™ Solutions

3M™ DBI-SALA® Engineered Modular Unit

Simplify adjustment and maximize flexibility without sacrificing safety. The highly customizable Flexiguard™ Engineered Modular Unit makes it possible.

This modular system features a lightweight design, allowing for easy mobility around the job site with a pallet jack or forklift. With three adjustable height models and one fixed height version—plus three mounting options—there is a configuration to fit virtually any need.

The 360 degree rotation mast allows for a 6 ft. (1.8 m) working radius from the anchor point. These systems are ANSI and OSHA compliant.

Engineered Modular Unit Systems

- Rotation handle included for turning system into working position.
- Installed rail with trolley.
- Rotational locking pin includes adjustments at every 11 degrees.

Fixed Height Systems

Anchor height	Offset	# of Users	Part #
21 ft. (6.4 m)	7 ft. (2.1 m)	1	8530571

Adjustable Height Jib Systems

Anchor height	Offset	Concrete	# of Users	Part #
10 ft.-15 ft. (3.05 m-4.57 m)	7 ft. (2.1 m)	n/a	1	8530557
13 ft.-20 ft. (3.96 m-6.10 m)	7 ft. (2.1 m)	n/a	1	8530558
15 ft.-25 ft. (4.57 m-7.62 m)	7 ft. (2.1 m)	n/a	1	8530559
15 ft.-25 ft. (4.57 m-7.62 m)	7 ft. (2.1 m)	without	2	8530538*

Base Configurations

Base type	Concrete	Part #
Flush floor mount	n/a	8530564
Top floor mount	n/a	8530565
5,000 lb. (2,268 kg) Counterweight	n/a	8530566
5,000 lb. (2,268 kg) Counterweight	without	8530621

*Includes counterweight base without concrete.

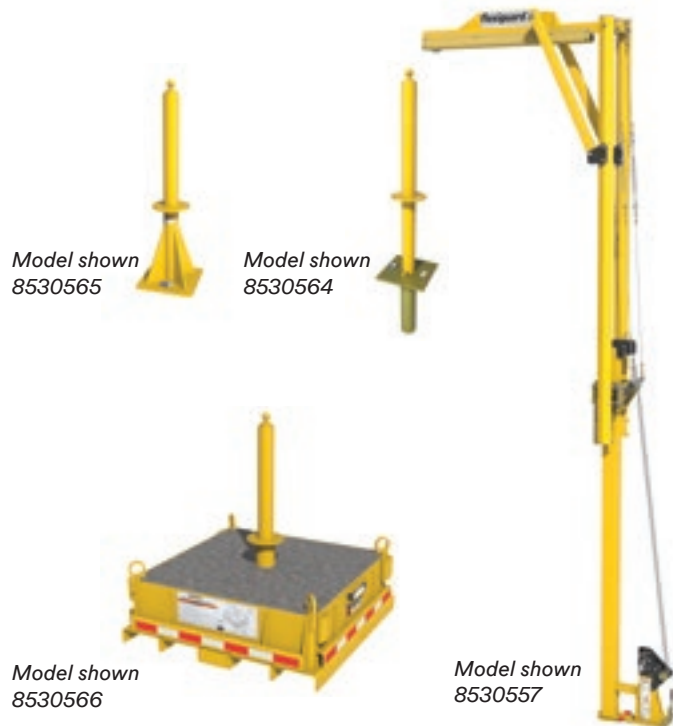
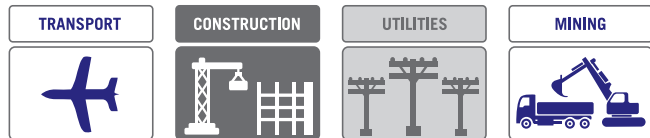
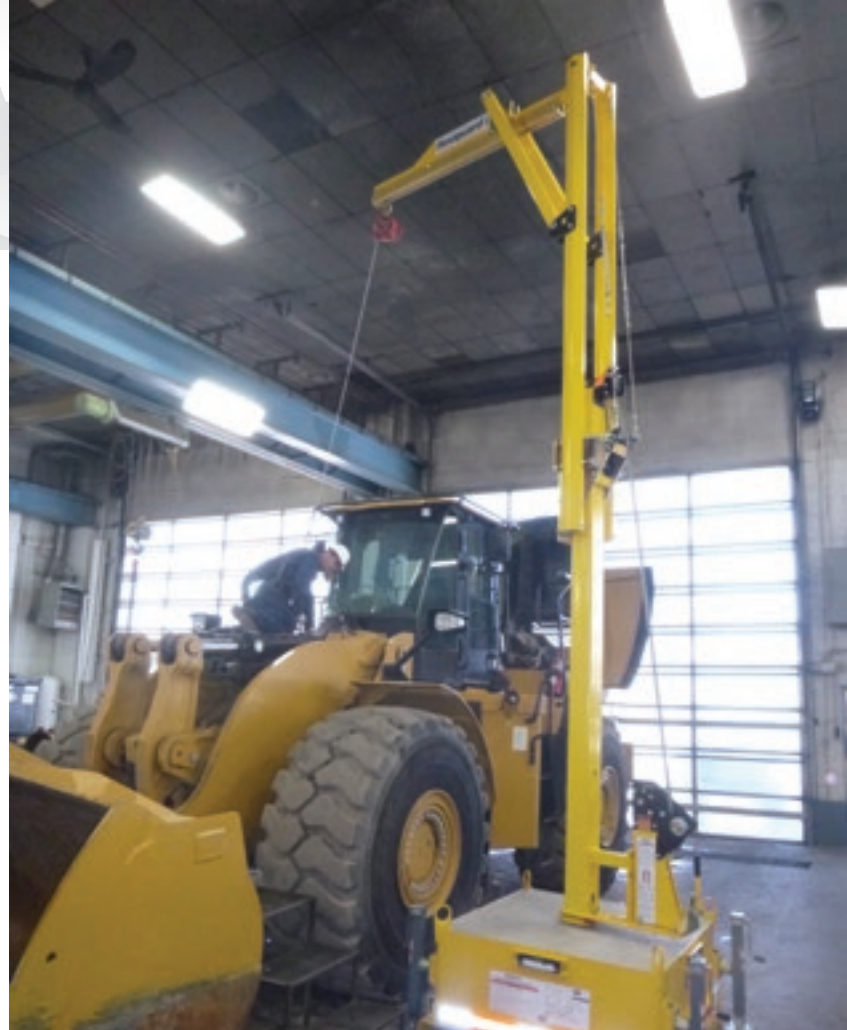

3M™ DBI-SALA® Counterweighted System

Create an overhead anchor point for multiple workers with ease. The Counterweighted System is a portable solution designed for counterbalancing by concrete or other means, allowing for close positioning to the work surface without obstructing the equipment being accessed. These systems are ANSI and OSHA compliant.

Counterweighted Systems

- Provide effective/economical means of anchoring overhead.
- Includes systems with and without the concrete counterweight on base of unit.
- Ideal in areas with no overhead obstructions and door height restrictions.
- System includes one rail with two trolleys.
- System includes heavy-duty leveling jacks and tag line assist.

Anchor height	Rail width	Offset	Weighted	# of Users	Part #
22 ft. (6.7 m)	32 ft. (9.8 m)	8 ft. (2.4 m)	not included	2	8517760
22 ft. (6.7 m)	32 ft. (9.8 m)	8 ft. (2.4 m)	included	2	8517761
22 ft. (6.7 m)	42 ft. (12.8 m)	8 ft. (2.4 m)	not included	2	8517762
22 ft. (6.7 m)	42 ft. (12.8 m)	8 ft. (2.4 m)	included	2	8517763

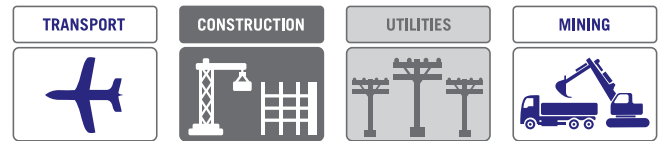

Model shown
8517760

Flexiguard™ Solutions

3M™ DBI-SALA® C-Frame System

A versatile fall arrest solution for working at height, the C-Frame System is designed to be moved manually or with the use of a tow bar and service vehicle. It requires some clearance under the equipment being accessed to accommodate outrigger support legs. These systems are ANSI, OSHA and CE compliant.

Adjustable Height Systems

- Adjustable by manually cranking winch.
- Most often used in areas with no overhead obstructions or door height restrictions.
- System includes heavy-duty leveling jacks.
- Each system includes one rail with two trolleys.



Anchor height	Rail width	Wheels	# of Users	Part #
12.5 ft.-19 ft. (3.8 m-5.85 m)	10 ft. (3 m)	16 in. (0.4 m) Pneumatic	2	8517701
12.5 ft.-19 ft. (3.8 m-5.85 m)	20 ft. (6.1 m)	16 in. (0.4 m) Pneumatic	2	8517705
17.5 ft.-28.75 ft. (5.3 m-8.8 m)	15 ft. (4.6 m)	16 in. (0.4 m) Pneumatic	2	8517707
17.5 ft.-28.75 ft. (5.3 m-8.8 m)	20 ft. (6.1 m)	16 in. (0.4 m) Pneumatic	2	8517709
22.5 ft.-38.75 ft. (6.8 m-11.8 m)	15 ft. (4.6 m)	16 in. (0.4 m) Pneumatic	2	8517711
22.5 ft.-38.75 ft. (6.8 m-11.8 m)	20 ft. (6.1 m)	16 in. (0.4 m) Pneumatic	2	8517713

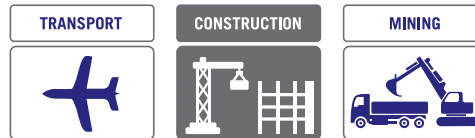

3M™ DBI-SALA® A-Frame System

The A-Frame System provides a secure anchor point on portable structures to give workers increased coverage and protection. Depending on the configuration, this system has the capacity to provide fall protection for up to two workers and can be easily moved from one job site to the next—providing safe and reliable fall protection where you need it. These systems are ANSI, OSHA and CE compliant.

Fixed Height Systems

- Provide effective/economical means of anchoring overhead.
- Each system contains a single rail rated for two users.
- Ideal in areas with no overhead obstructions or door height restrictions.
- System includes heavy-duty leveling jacks.

Anchor height	Rail width	Wheels	# of Users	Part #
15 ft. (4.6 m)	15 ft. (4.6 m)	16 in. (0.4 m) Caster	2	8517790
15 ft. (4.6 m)	20 ft. (6.1 m)	16 in. (0.4 m) Caster	2	8517791
15 ft. (4.6 m)	30 ft. (9.1 m)	16 in. (0.4 m) Caster	2	8517792
20 ft. (6.1 m)	15 ft. (4.6 m)	16 in. (0.4 m) Caster	2	8517793
20 ft. (6.1 m)	20 ft. (6.1 m)	16 in. (0.4 m) Caster	2	8517794
20 ft. (6.1 m)	30 ft. (9.1 m)	16 in. (0.4 m) Caster	2	8517795
30 ft. (9.1 m)	15 ft. (4.6 m)	16 in. (0.4 m) Caster	2	8517796
30 ft. (9.1 m)	20 ft. (6.1 m)	16 in. (0.4 m) Caster	2	8517797
30 ft. (9.1 m)	30 ft. (9.1 m)	16 in. (0.4 m) Caster	2	8517798

Adjustable Height Systems

- Can be adjusted using overhead crane, forklift or powered systems.
- Each system contains two rails for bypassing trolleys.
- Ideal in areas with overhead obstructions and door height limitations where lowering the overall height of the A-Frame is a requirement.
- System includes heavy-duty leveling jacks.

Anchor height	Rail width	Wheels	# of Users	Part #
16 ft.-22.5 ft. (4.9 m-6.9 m)	20 ft. (6.1 m)	16 in. (0.4 m) Pneumatic	2	8517780
16 ft.-22.5 ft. (4.9 m-6.9 m)	30 ft. (9.1 m)	16 in. (0.4 m) Pneumatic	2	8517781

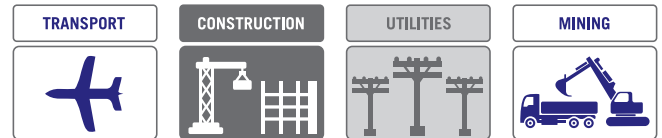

Flexiguard™ Solutions

Flexiguard™ Solutions

3M™ DBI-SALA® Freestanding Ladder System

Easy access. 100% fall protection from the ground up. Achieve both for up to two users for the duration of the work with our Freestanding Ladder System. System configurations include guardrails and the use of multiple SRLs. These models are ANSI, OSHA and CE compliant.

Adjustable Height Systems

- Manual height adjustment via winch assembly.
- Multiple height adjustment ranges available.
- All systems include a fall arrest bar for accessing ladder.
- System includes heavy-duty leveling jacks.

Platform height	System type	Wheels	# of Users	Part #
10.75 ft.-15.5 ft. (3.3 m-4.7 m)	Portable ladder	16 in. (0.4 m) Pneumatic	2	8517715
14.5 ft.-23 ft. (4.4 m-7.0 m)	Portable ladder	16 in. (0.4 m) Pneumatic	2	8517717
18.25 ft.-31 ft. (5.6 m-9.4 m)	Portable ladder	16 in. (0.4 m) Pneumatic	2	8517719



Model shown
8517715

3M™ DBI-SALA® Sky Anchor System

Increase coverage and protection with the secure anchorage point of a Sky Anchor Solution. All systems are rated for one-person use and provide 360 degree mobility within the safe working radius from the anchor point. All available systems incorporate a collapsible design for easy setup, as well as a variety of bases for securing the system onto any job site. These systems are ANSI and OSHA compliant.



Sky Anchor Systems

- Lightweight aluminum construction.
- Collapsible design.
- 360 degree mast rotation.
- 6 ft. (1.8 m) safe working radius from anchor.

Anchor height	Offset	# of Users	Part #
15.25 ft. (4.6 m)	6 ft. (1.8 m)	1	8530152
18.75 ft. (5.7 m)	6 ft. (1.8 m)	1	8530161
21.25 ft. (6.5 m)	6 ft. (1.8 m)	1	8530387
23.25 ft. (7.1 m)	7 ft. (2.1 m)	1	8530320

Sky Anchor Base Configurations

- Each base option can be used with each Sky Anchor option.
- Each base option is rated for one user.

Base image	Base type	Part #
	Top floor mount	8530210
	Core mount sleeve	8530314
	Flush floor mount	8530162*

*Base Cap option can be used with this base.

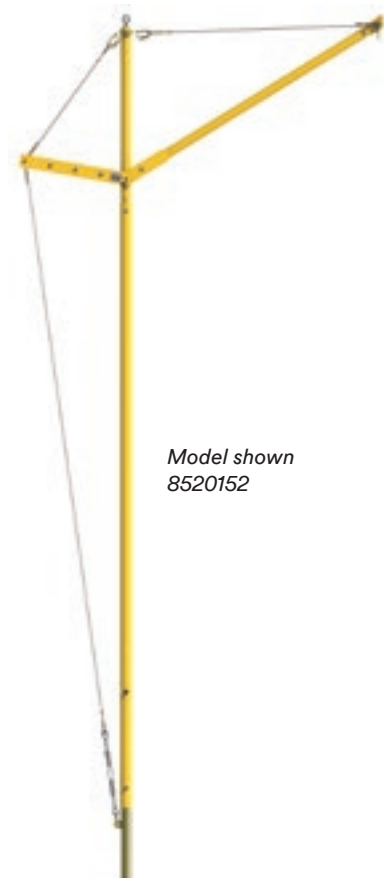
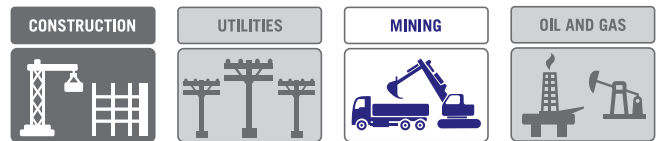

Model shown
8520152

Flexiguard™ Solutions

3M™ DBI-SALA® Supported Ladder System

Provide for safe access and maintenance of transportation vehicles across a wide variety of different applications and environments with our portable Supported Ladder System.

This unique solution offers the best in passive and active fall protection. The work platform is fully enclosed by guardrails for superior passive fall protection and easily accessible through two spring-loaded swing gates.

You can also access the working surface of the vehicle through one spring-loaded gate while tied off to the active fall arrest rail. This system is ANSI and OSHA compliant.

Supported Ladder System

- Heavy-duty steel base design with an aluminum platform and fall arrest rail.
- Work platform is covered in a non-slip material.
- System equipped with two heavy-duty stabilizing jacks and two retracting outriggers that can be set without having to go beneath the work surface.

Platform height	Platform length	Platform width	Rail length	Wheels	# of Users	Part #
9 ft. (2.7 m)	9 ft. (2.7 m)	3 ft. (0.9 m)	12 ft. (3.7 m)	8 in. (0.2 m) Urethane	1	8530397



3M™ DBI-SALA® Box Frame

Conveniently secure a fall arrest rigid rail in areas with limited space or inadequate overhead structure. Our Box Frame Systems are built to accommodate a specific area or piece of equipment and can be designed as permanent or portable frames, allowing for easy relocation. These systems are ANSI and OSHA compliant.

Fixed Height Systems

- Provide effective/economical means of anchoring overhead.
- Ideal in areas with no overhead obstructions or door height restrictions.

Anchor height	Width	Rail length	Wheels	# of Users	Part #
14 ft. (4.3 m)	14 ft. (4.3 m)	Dual rail 15.5 ft. (4.7 m) each	16 in. (0.4 m) Pneumatic	2	8530345
21 ft. (6.4 m)	15 ft. (4.6 m)	Single rail 28 ft. (8.5 m)	12 in. (0.3 m) Rubber	2	8530361
30 ft. (9.1 m)	20 ft. (6.1 m)	Dual rail 32 ft. (9.8 m) each	16 in. (0.4 m) Pneumatic	2	8530427

Adjustable Height System

- Adjustable using overhead crane, forklift or powered systems.
- Pin height selection system.
- Ideal in areas with overhead obstructions and door height limitations.

Height	Width	Length	Wheels	# of Users	Part #
12 ft.-18 ft. (3.7 m-5.5 m)	12 ft. (3.7 m)	Single rail 20 ft. (6.1 m)	12 in. (0.3 m) Rubber	2	8530288

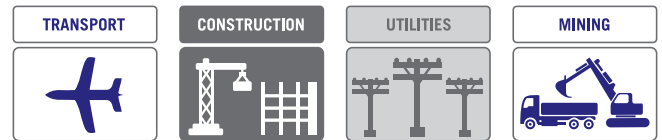

Model shown
8530345

Flexiguard™ Solutions





3M™ DBI-SALA® Trailer & Hitch-Mounted Anchor Systems

One simple solution. Endless versatility. Our Trailer & Hitch-Mounted Systems are DOT-rated portable systems that can be attached to a service vehicle hitch receiver for transport to a job site. They provide a standalone solution, leveraging an integrated counterweight or easy attachment to a truck or service vehicle with minimal setup required before use. These systems incorporate overhead anchorage points up to 22 ft. (6.7 m) for a maximum of two users, and are OSHA and ANSI compliant.

Fixed Height Systems

- Trailer and Hitch mounted solutions are DOT rated to maximize portability and versatility to and from job site.
- System quickly raises and lowers with integrated winch and handle.
- System includes heavy-duty stabilizing jacks.

Anchor height	Width	# of Users	Part #
21.5 ft. (6.6 m)	7.2 ft. (2.2 m)	2	8530624
21.5 ft. (6.6 m)	7.0 ft. (2.1 m)	2	8530690
22 ft. (6.7 m)	6.5 ft. (2.0 m)	2	8530691

TRANSPORT 	CONSTRUCTION 	UTILITIES 	MINING 
---	--	---	--

Accessory	Applies to	Part #
Drive Clutch Assembly	8530624, 8530690, 8530691	8548000
Job Box	8530690	8530678
Outrigger Pads	8530690, 8530691	8548050



Model shown
8548000



Model shown
8548050



Model shown
8530678



Model shown
8530624
Attachment
not included



Model shown
8530690
Attachment
not included

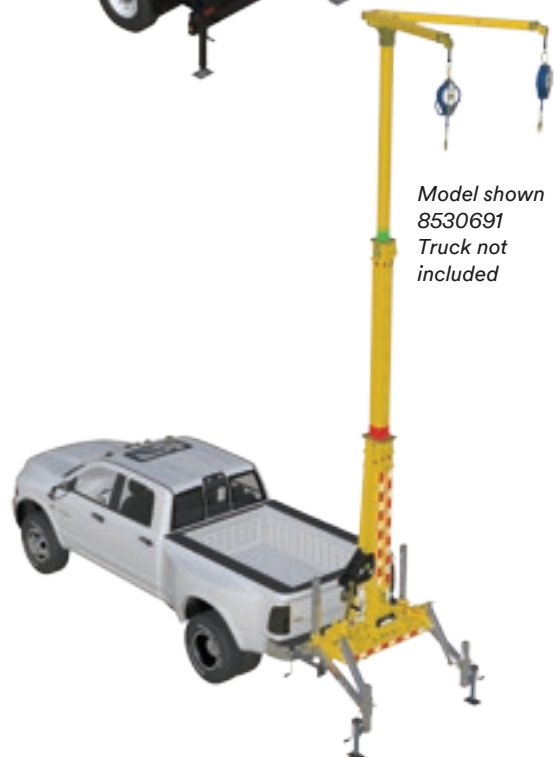

Model shown
8530691
Truck not
included



Flexiguard™ Solutions



Confined Space Rescue

Get in
easily.
Get out
safely.



Breathe easy, even in tight spaces. That's the kind of confidence and peace of mind that comes from having a customized rescue and retrieval system nearby. Our extensive line of high quality, rugged systems are proven and trusted by safety engineers and site directors alike to rescue workers in confined spaces quickly and flawlessly—every time. They also meet all applicable industry standards to ensure quality and compliance.

What to look for in a confined space rescue system:

Ease-of-use

Your systems must provide you with the ability to handle a crisis simply, flawlessly and immediately. During an emergency, time is of the essence.

Mechanical systems

Lifeline type and length are just a few of the options you may need to consider. In some situations, a back-up system may be required.

Durability

All system components must be made from quality materials strong enough to endure rough handling and exposure to the elements.

Versatility

Your system should be adjustable and adaptable to extreme environments and uneven terrain. A modular design is also helpful, allowing you to add to the system over time.

Strength

Your system must be rated for your application, such as fall arrest, rescue, man-riding or material handling. Choose one that maximizes strength and minimizes weight.

Portability

Your system should be lightweight and easy to transport, set up and store.



3M™ DBI-SALA®

Davit Arm System Components

Variable offset davits are designed for use where multiple offset masts are required. The variable offset masts may be equipped with front mounted and/or back mounted winches or Self-Retracting Lifelines (SRLs) and feature an anchor point rated up to 5,000 lbs. (22 kN), depending on pin position. For applications with overhead clearance restrictions, the adjustable height of the variable offset masts can eliminate the need for custom length masts and mast extensions. Quick-connect/release pins allow for fast and easy setup, dismantle and transport.

1 Winch

Davits can be equipped with both primary and secondary (back-up) mechanical devices for added flexibility.

2 Quick-mounting brackets

Simple detent-style winch mounting brackets make installation fast and efficient. (See page 175 for options.)

3 3-way SRL

Davits can be equipped with both primary and secondary (back-up) mechanical devices for added flexibility.

4 Lower mast extensions

Allow the user to increase the overall anchorage height of the system.

5 Base options

Several portable and fixed base options are available for complete versatility.

6 Variable offset mast

Adjustable length of davit ensures lifelines are always centered over confined space.

7 Built-in pulleys

Route lifelines of two mechanical devices for smooth, efficient operation.

8 Fall arrest anchorage

Up to a 5,000 lb. (22 kN) rated anchor point for fall arrest device.

9 Adjustable height

Eliminates the need for custom length masts and extensions.

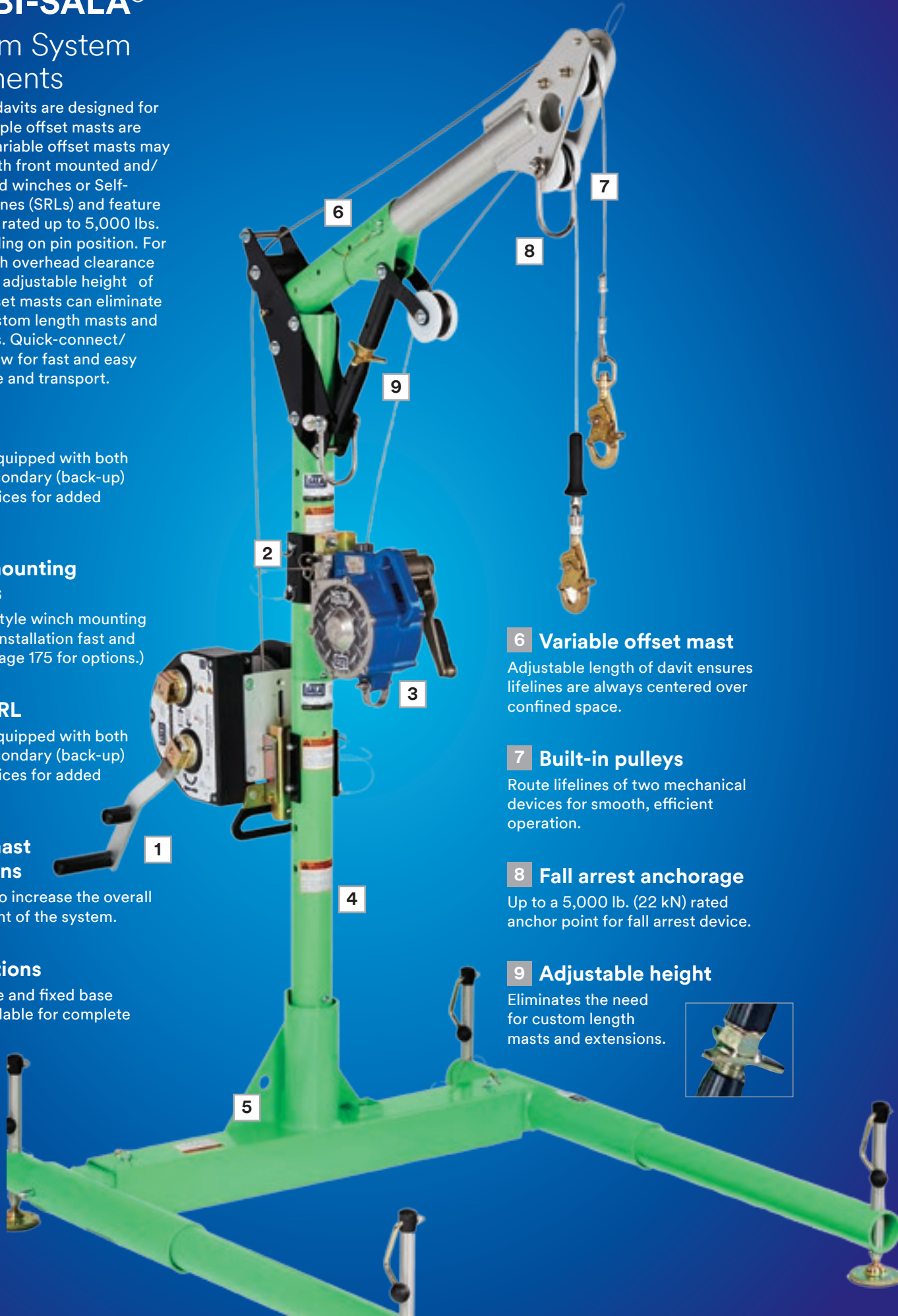



3M™ DBI-SALA®

One-Piece Adjustable Offset Davit Masts

Adjustable offset davit mast	66 in.-76 in. (167.6 cm-193 cm)	78 in.-88 in. (198.1 cm-223.5 cm)	90 in.-100 in. (228.6 cm-254 cm)	69.5 in.-87.5 in. (176.5 cm-222.2 cm)	81.5 in.-91.5 in. (207 cm-232.4 cm)	93.5 in.-111.5 in. (237.5 cm-282.2 cm)
11-1/2 in.-27-1/2 in. (29.2 cm-69.8 cm)	8518382	8518383	8518384			
23-1/2 in.-42-1/2 in. (59.7 cm-108 cm)				8518385	8518386	8518387

Offset Davit Masts & Lower Mast Extensions

Customize either one of these davit masts with up to two Lower Mast Extensions. The extensions provide the flexibility to change the overall mast height of your system. Custom lengths are also available. Call us for details.

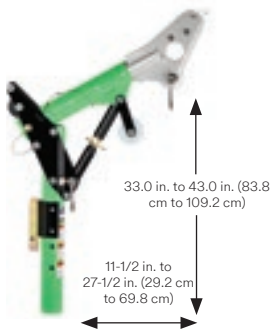

8518001 11-1/2 in.-27-1/2 in. Adjustable Offset Davit Mast

(includes winch mount bracket)
Combine this one-piece davit mast with up to two lower mast extensions to increase the anchorage height. Combined extension length cannot exceed 90 in. (228 cm).



8518006 23-1/2 in.-42-1/2 in. Adjustable Offset Davit Mast

(includes winch mount bracket)
Combine this one-piece davit mast with up to two lower mast extensions to increase the anchorage height. Combined extension length cannot exceed 78 in. (198 cm).

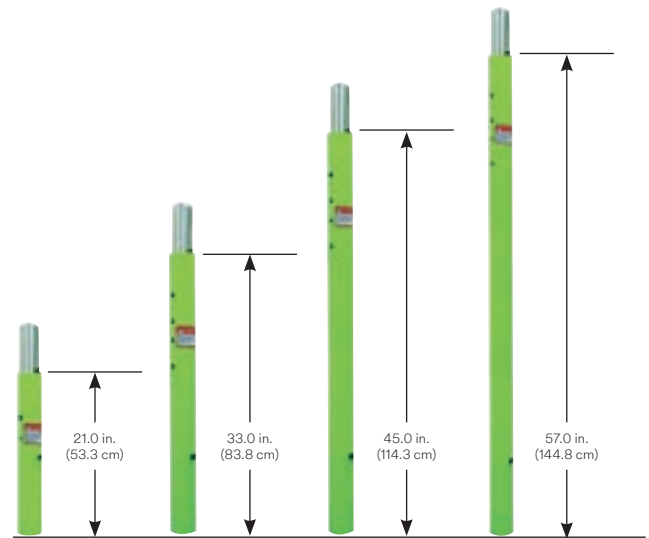

8518509 8518002 8518003 8518004

8518509 21 in. (53.3 cm) Lower Mast Extension

8518002 33 in. (83.8 cm) Lower Mast Extension

8518003 45 in. (114.3 cm) Lower Mast Extension

8518004 57 in. (144.8 cm) Lower Mast Extension

Bags and Accessories



8513330 Carrying Bag

Bag with protective plastic liner for Adjustable Offset Davit Masts.

8513564 Bag with protective plastic liner for Adjustable Offset Davit Mast, with Lower Mast Extension.

3M™ DBI-SALA®

Fixed Bases

Fixed Bases work with a variety of Davit Arm and Mast Extensions. They allow for easier setup and teardown, making them an ideal solution for work areas where a base can be permanently installed to an existing structure.





8516190
Floor Mount Sleeve
Zinc-Plated

Mild steel construction. Mounts to horizontal concrete or steel structure. Comes with PVC sleeve liner.

Weight: 13 lbs. (5.9 kg)

8518347 Floor Mount Sleeve, stainless steel construction

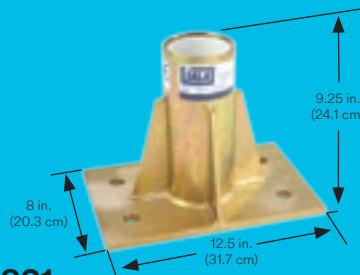

8512831
Center Mount Sleeve
Zinc-Plated

Mild steel construction. Mounts to existing steel by welding or bolting. Comes with PVC sleeve liner.

Weight: 13 lbs. (5.9 kg)

8516563 Center Mount Sleeve, stainless steel construction

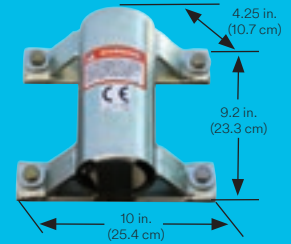

8518348
Wall Mount Sleeve 304
Stainless Steel

304 stainless steel construction. Compact design creates minimum intrusion into work space. Mounts to vertical concrete or steel structures. Comes with PVC sleeve liner.

Weight: 12 lbs. (5.5 kg)

8516191 Wall Mount Sleeve, zinc-plated mild steel construction

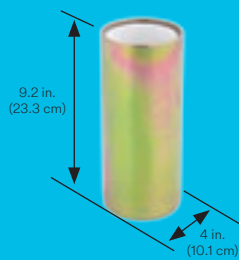

8510109
Core Mount Sleeve

Zinc-plated mild steel construction. Designed for slip-in installation into 4 in. (10.1 cm) core hole in concrete or in an existing steel structure. Comes with PVC sleeve liner.

Weight: 8 lbs. (3.6 kg)

8510110 Core Mount Sleeve, stainless steel construction

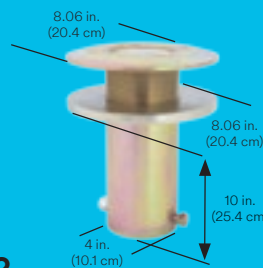

8515162
Deck Mount Sleeve

Zinc-plated mild steel construction. Designed to slip into a 4 in. (10.1 cm) hole in existing flooring. Flush mount design allows passage of traffic and eliminates trip hazards when not in use. Comes with PVC sleeve liner, plastic stopper and mounting hardware – mounts to thicknesses from 1/4 in.-2 in. (6.4 mm-50.8 mm).

Weight: 17 lbs. (7.7 kg)

8515834 Deck Mount Sleeve, stainless steel construction

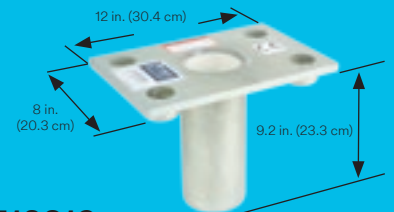

8510316
Floor Mount Sleeve

Mild steel construction. Recessed fastener pockets allow for bolt-in installation into existing concrete or steel structure. Flush mount design allows passage of traffic and eliminates trip hazards when not in use. Comes with PVC sleeve liner.

Weight: 21 lbs. (9.5 kg)

8512827 Flush Floor Mount Sleeve, stainless steel construction

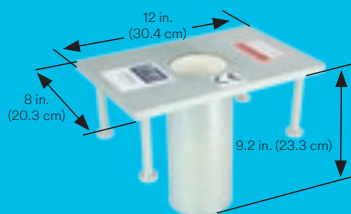

8510311
Flush Floor Mount Sleeve

Mild steel construction. Comes with pins for fresh concrete and cast-in-place concrete anchors for new construction or renovation. Flush mount design allows passage of traffic and eliminates trip hazards when not in use. Comes with PVC sleeve liner.

Weight: 21 lbs. (9.5 kg)

8512828 Flush Floor Mount Sleeve, stainless steel construction

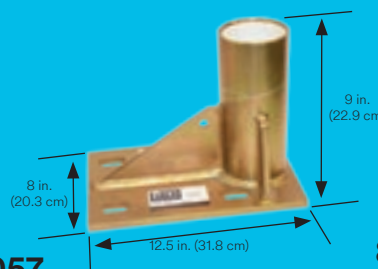

8510057
Offset Floor Mount Sleeve

Zinc-plated mild steel construction. Mounts to horizontal concrete or steel structure. The offset design allows for maximum reach of the mast being used. Comes with PVC sleeve liner.

Weight: 25 lbs. (11.3 kg)



8510827
Heavy-Duty Sleeve Cap

Stainless steel construction, used with permanent mounted sleeves when installed in high traffic or other severe service locations.

Weight: 1.2 lbs. (0.54 kg)

8510826 Heavy-Duty Sleeve Cap, zinc-plated mild steel construction

3M™ DBI-SALA®

Hoist Systems

Adaptability and portability. They're both essential to successful manhole or confined space entry and retrieval. That's why we've engineered our Hoist Systems with lightweight materials like high-strength aluminum and made them adjustable and extendable to meet the specific needs of your job site. If you're not sure what you need, please call us and we'll create your customized solution to maximize ease-of-rescue—even in complex environments.



Confined Space Rescue

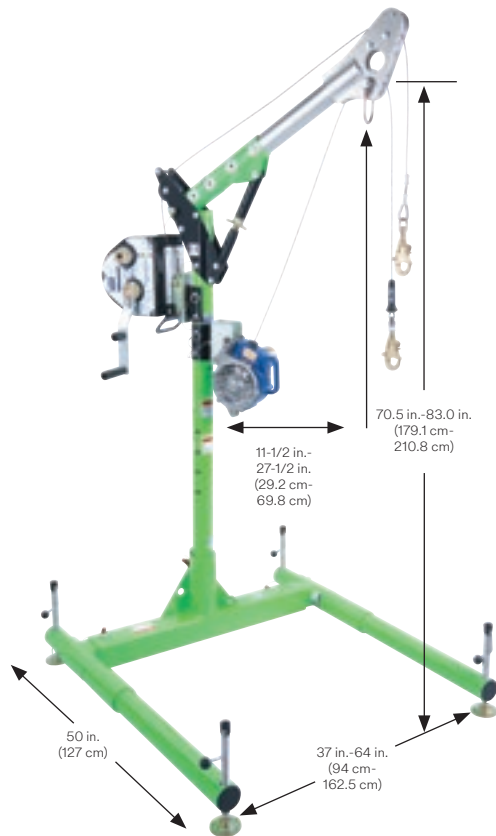

8518000

3M™ DBI-SALA® 5-Piece Hoist System

Davit arm and base system includes 11-1/2 in.-27-1/2 in. (29.2 cm-69.8 cm) Adjustable Offset Upper Mast (8518001), 33 in. (83.8 cm) Lightweight Lower Mast (8518002), and 3-Piece Lightweight Base (8518005). Includes winch mounting bracket. Order winch and Self-Retracting Lifeline separately.
Weight: 100 lbs. (45.5 kg)

Bags and Accessories

8518270

5-Piece Equipment Cart

Transport the 5-Piece System with maximum ease over smooth or rough terrain. Ideal for tight storage situations.

8518513 Set of two carrying bags for 5-Piece Hoist System (8518000)



8518040

5-Piece Hoist System

Davit arm and base system includes 23-1/2 in.-42-1/2 in. (59.7 cm-108 cm) Adjustable Offset Upper Mast (8518006), 33 in. (83.8 cm) Lightweight Lower Mast (8518002), and 3-Piece Lightweight Base (8518008). Includes winch mounting bracket. Order winch separately.
Weight: 137.5 lbs. (62.3 kg)

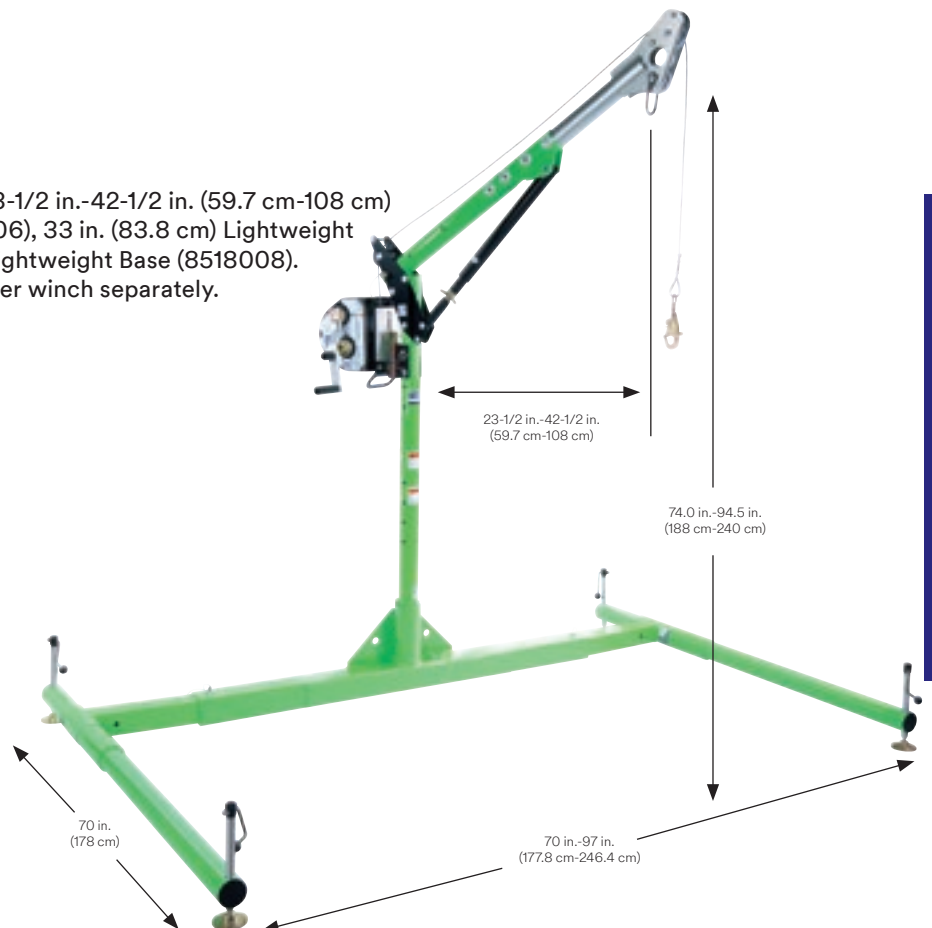

Confined Space Rescue

3M™ DBI-SALA®

Portable Bases

Portable Bases work with a variety of Davit Arm and Mast Extensions. They're ideal when you need to move and access various confined space areas. Bases are lightweight, easy to transport, set up and use.

8518005

3-Piece Portable Base

Adjustable base for 27-1/2 in. (69.8 cm) maximum offset davit mast.

8518008 3-Piece Portable Base. Adjustable base for 42-1/2 in. (108 cm) maximum offset davit mast

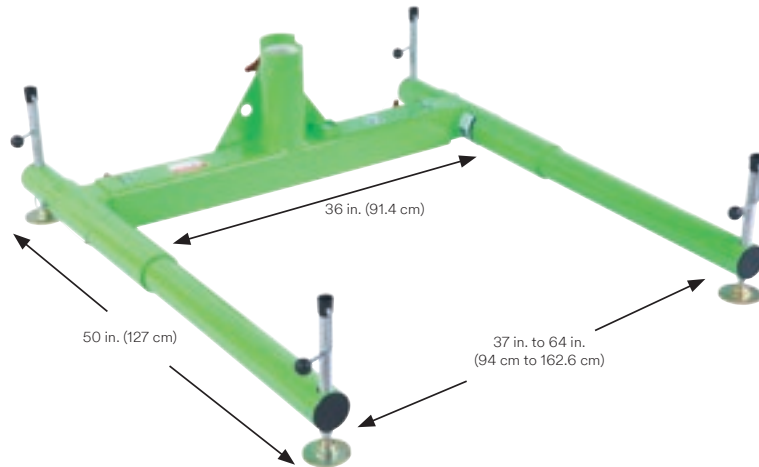

8513565

Carrying Bag

Bag with protective plastic liner for 3-Piece Davit Base (8518005).



8510323

Barrel Mount Sleeve with 3.5 in. (89 mm) Opening

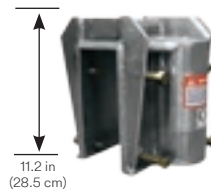

Mild steel construction. Eight independent clamping screws allow temporary installations over edges of shoring cans, walls and other structures. Comes with PVC inner liner. Custom fit openings available.

8510429 Barrel Mount Sleeve with 3 in. (76.2 mm) opening, stainless steel

8519377

External Tank Cover

Comes with Adjustable Sleeve Assembly (8511232). Used on manways with a flange structure that the unit may be secured onto. This collar can clamp onto 6 in. (15.2 cm) max thick flange.

Weight: 82 lbs. (37.2 kg)

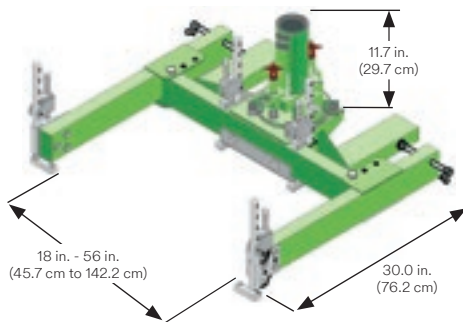

8512285

Adjustable Barrel Mount Sleeve

Designed for shoring, wall and parapet applications. Standard unit accommodates wall thicknesses up to a maximum of 24 in. (60.9 cm), with shorter or longer adjustment tubes available on request. Anodized, welded aluminum with zinc-plated steel hardware with inner sleeve.

8510715 Adjustable Barrel Mount Sleeve for 0 in.-12 in. opening.

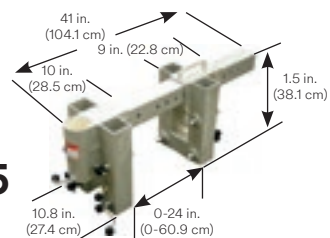

8510568

Forklift Basket

Designed to convert your forklift into a versatile confined space and fall arrest work platform. Add a davit mast and winch/Self-Retracting Lifeline to the basket and you're ready to go. Lightweight aluminum construction and tool-free assembly simplifies setup, transport and storage. Durable powder coated finish with anti-slip finish on walking surfaces. Includes spring-loaded gate.

Weight: 215 lbs. (98 kg)

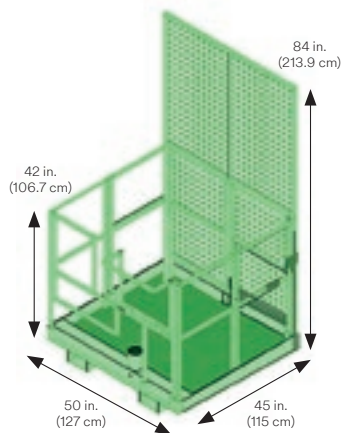

8510501

3M™ DBI-SALA® Manhole Collars

17.5 in. (44.5 cm) Manhole Collar, fits 18 in.-20 in. (45.7 cm-50.8 cm) diameter. Provides a Portable Davit Base by simply fitting within manhole opening. Powder coated aluminum construction with PVC sleeve liner.

8510520 19.5 in. (49.5 cm) Manhole Collar fits 20 in.-22 in. (50.8 cm-55.8 cm) diameter

8510457 21.5 in. (54.6 cm) Manhole Collar fits 22 in.-24 in. (55.8 cm-60.9 cm) diameter

8510163 23.5 in. (59.7 cm) Manhole Collar fits 24 in.-26 in. (60.9 cm-66 cm) diameter

8510633 25.5 in. (64.7 cm) Manhole Collar fits 26 in.-28 in. (66 cm-71.1 cm) diameter

8510632 27.5 in. (69.8 cm) Manhole Collar fits 28 in.-30 in. (71.1 cm-76.2 cm) diameter

8510546 29.5 in. (74.9 cm) Manhole Collar fits 30 in.-32 in. (76.2 cm-81.2 cm) diameter

8512994 33.5 in. (83.1 cm) Manhole Collar fits 34 in.-36 in. (86.3 cm-91.4 cm) diameter.



8514461

Vehicle Hitch Mount Sleeve

Designed to install into a 2 in. (51 mm) hitch receiver on an attendant vehicle to provide a portable anchor point for confined space entry, rescue and fall arrest systems. Assembly for a maximum 42-1/2 in. (108 cm) Offset Davit Mast.

8510140 Assembly for a maximum 27-1/2 in. (69.8 cm) Offset Davit Mast

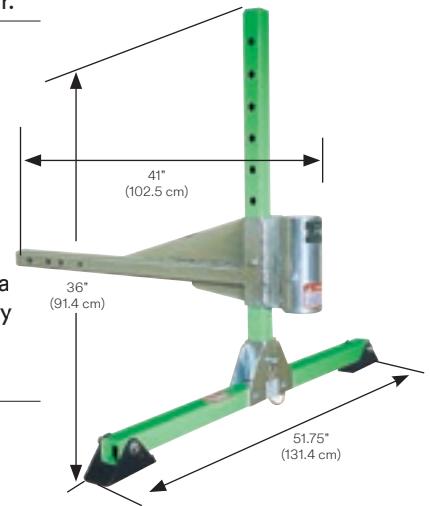

Vehicle Hitch Sleeve Extensions

A maximum of one extension can be used with a hitch mount and a bumper attachment.



8514503 2 ft. (0.61 m) Vehicle hitch mount sleeve extension
Weight: 17 lbs. (7.7 kg)

8512829 4 ft. (1.21 m) Vehicle hitch mount sleeve extension
Weight: 27.8 lbs. (12.6 kg)

8511384 6 ft. (1.83 m) Vehicle hitch mount sleeve extension
Weight: 39 lbs. (17.6 kg)

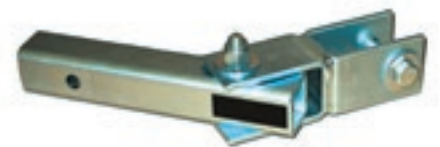

8511401

Universal Joint Assembly

Installs between the Hitch Mount Sleeve (8510140) or extension and the vehicle to compensate for uneven ground conditions.

Weight: 10 lbs. (4.5 kg)

Confined Space Rescue



3M™ DBI-SALA®

Counterweight Systems

Counterweight Systems composed of a central base unit to accommodate a variety of anchoring options, positioning and adjustment legs, and extension assemblies. Anchoring options include a weight rack for counter balanced applications, and a wheel pad assembly to allow counter balance of the unit with an attendant vehicle.

8512894

Counterweight System

Counterweight system base with pole leg assembly.

Weight: 199 lbs. (90.2 kg)

Counterweight requirements determined by application. Contact customer service to order.



Davit mast and winch not included—order separately.

8514496

Counterweight System

Counterweight system base with screw leg assembly.

Weight: 192 lbs. (87.1 kg)

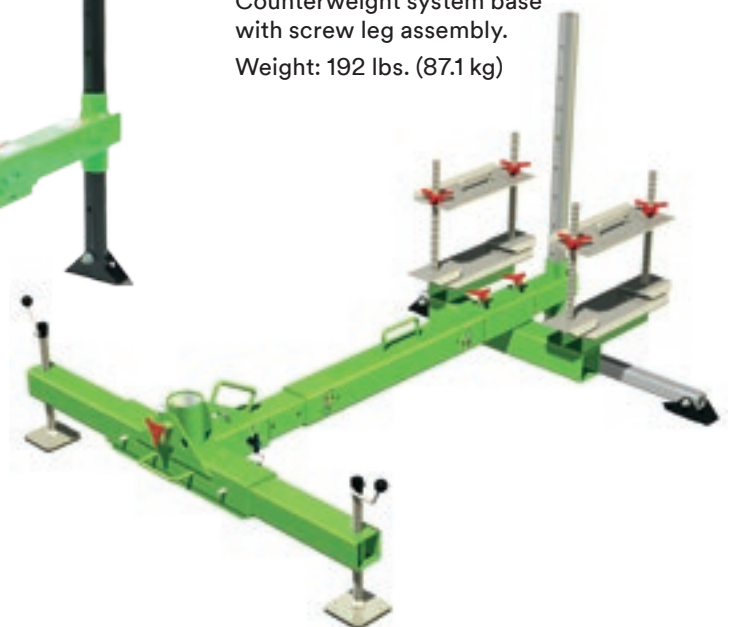

3M™ DBI-SALA®

Counterweight Systems

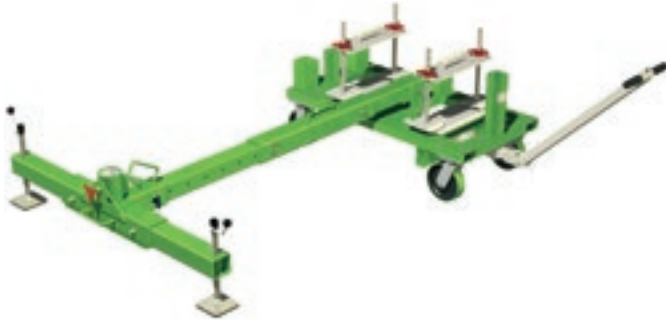

8520775

Mobile Counterweighted Cart Base

Ideal for areas that require access near a leading edge or into large tanks. System comes complete with counterweight cart, 36 in. (91.4 cm) inner extension tube, center section, and two outrigger screw assemblies. System counterweighted by 50 lb. (22.7 kg) weight plates. (Weight plates, davit mast and winch not included—order separately.)



8530088

Portable Catwalk Clamping Base

Designed to secure to 36 in. (91.4 cm) wide walkways. Ideal for areas that require access off a mezzanine or walkway. System comes complete with catwalk hook, 16 in. (40.6 cm) inner extension tube, center section, and two outrigger screw assemblies. Other models available to accommodate different widths of walkways. (Davit mast and winch not included—order separately.)



8530256

Portable Anchor Point Base

Ideal for areas that require access over a leading edge. System comes complete with U-bolt anchor point to attach to secondary fixed anchor, 36 in. (91.4 cm) inner extension tube, center section, and two outrigger screw assemblies. System requires a 5,000 lb. (22 kN) anchorage point to be tied down to. (Davit mast and winch not included—order separately.)



8511892

Portable Rail Clamping Base

Ideal for rail accessed areas, including over the edge of a rail bridge. System comes complete with a rail bridge clamp which anchors the base, 36 in. (91.4 cm) inner extension tube, center section, and two outrigger screw assemblies. (Davit mast and winch not included—order separately.)

3M™ DBI-SALA®

Tripods

Our Tripods are constructed of lightweight tubular aluminum with a rugged steel head assembly. The UCT Series Tripods can be combined with up to three pulleys to accommodate a variety of winches and fall arrest devices, meeting a wide range of confined space entry/retrieval and rescue requirements. Quick-release pins positively locate components at all adjustment points for tool-free setup and adjustment.

1 Mechanical devices

Can support up to three winches or Self-Retracting Lines (SRLs) for complete flexibility.

2 Quick-connect bracket

Allows fast and easy attachment of mechanical devices.

3 Safety chain

Provides added support and strength for demanding confined space applications.

4 Top mounted pulley system

Mount up to three pulleys to route mechanical device lifelines for smooth operation.

5 Secondary anchor point

5,000 lb. (22 kN) anchor point for secondary fall arrest system.

6 Aluminum construction

Extremely lightweight yet durable construction for ease-of-use and longevity.

7 Telescoping legs

Provide fast adjustment and cannot disengage, for added worker satisfaction.

8 Adjustable height legs

Fast and easy detent pin-style adjustment allows for precise height setting.

9 Inner leg liners

Allow for smooth positive connection and operation of leg adjustment.

10 Foot pads

Include sharp points for biting into soft ground and/or uneven terrain.

8513159

UCT-1000 10 ft. (3.05 m) Tripod

With adjustable locking legs, safety chains, top pulley and winch bracket.

Weight: 68 lbs. (30.8 kg)

Capacity: 450 lbs.

Winch not included—order separately.

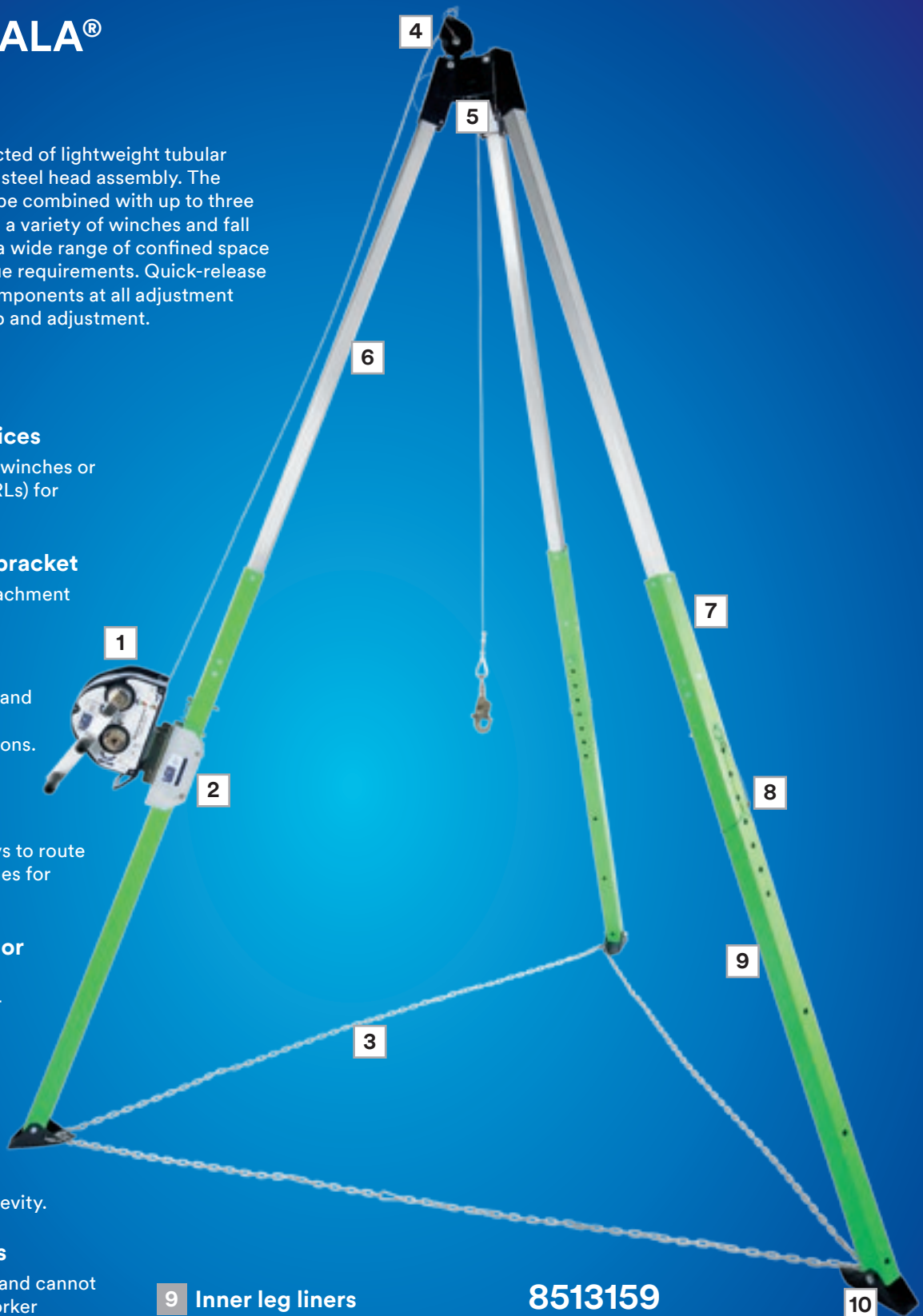

8513158

3M™ DBI-SALA® UCT-300 7 ft. (2.13 m) Tripod

- Lightweight, durable aluminum construction with powder coat finish.
- Includes quick-connect winch mount bracket—can accommodate up to three brackets.
- Includes top mounted pulley system—can accommodate up to three pulleys.
- Telescoping adjustable locking legs for easy setup.
- Fast detent pin-style adjustment and locking.
- Inner plastic liners provide smooth adjustment.
- Foot pads include sharp points for biting into soft ground or uneven terrain.
- Safety chain for added support, strength and safety.
- 5,000 lb. (22 kN) built-in head mounted anchor point.
- Capacity: 450 lbs.



Winch and SRL not included—order separately.

8000000

7 ft. (2.13 m) Aluminum Tripod

- Lightweight, durable aluminum construction.
- Includes quick-connect winch mount bracket.
- Includes top mounted pulley system.
- Telescoping adjustable locking legs for easy setup.
- Fast detent pin-style adjustment and locking.
- Rubber safety shoes with spiked edges for different terrains.
- Safety chain for added support, strength and safety.
- 5,000 lb. (22 kN) built-in head mounted anchor points.
- Capacity: 450 lbs.



8000010 9 ft. (2.7 m) Aluminum Tripod with adjustable locking legs, safety chains, top pulley and winch bracket

Winch not included—please order separately.

Accessories

8513330

Carrying Bag for 10 ft. (3 m) Tripod with protective plastic liner (8513159).

8513329 Carrying Bag for 7 ft. (2.1 m) tripod with protective plastic liner (8513158)

9503094 Carrying Bag for 7 ft. (2.1 m) tripod (8000000)

9503095 Carrying Bag for 9 ft. (2.7 m) tripod (8000010)



8512292

Winch/SRL Mounting Bracket for Tripod (8513159)

Attaches to the leg tube with quick-release pins for tool-free setup and adjustment.

Weight: 5.2 lbs. (2.4 kg)



8510224

Winch/SRL Mounting Bracket for Tripod (8513158)

Attaches to the leg tube with quick-release pins for tool-free setup and adjustment.

Weight: 3 lbs. (1.4 kg)

Also see accessories on page 175 for additional bracket options.



8512293

Top Pulley Assembly for UCT Series Tripods

Pulleys are mounted on top of the head assembly to route mechanical device's lifeline over and into confined space area.

Weight: 1.6 lbs. (0.73 kg)



3M™ DBI-SALA®

Cantilever Rescue System

From roof edges and parapets to guardrails, cliffs and bridges, complex situations require versatile rescue systems. Our Cantilever Rescue System quickly and easily converts the 10 ft. (3.05 m) Tripod (8513159) into high-angle rescue equipment. Using the rigid wheel pad supplied with the kit, the Cantilever System can be anchored with a service vehicle's weight, weight rack or with a single anchor point.

1 Aluminum construction

Extremely lightweight yet durable construction for ease-of-use and longevity.

2 Quick-mount bracket

Allows fast and easy attachment of mechanical devices.

3 Wheel pad

Provides easy means to anchor system with service vehicle's weight or weight rack kit.



4 Adjustable height legs

Fast and easy detent pin-style adjustment allows for precise height setting.

5 Telescoping legs

Provide fast adjustment and cannot disengage, for added worker satisfaction.

6 Leg support system

Provides tripod leg support to use in cantilever rescue configuration.



8530257

Cantilever Rescue System

Complete with 10 ft. (3.05 m) Tripod (8513159), Rigid Wheel Pad (8515620) and attachment hardware, Weight Rack Kit (8515631), Leg Support System (8514540) and Top Mount Pulley (8515150).

Winch not included—order separately.

8515150 Top Mount Pulley for Cantilever System

Allows system to handle two mechanical devices (winch and self-retracting lifeline).

Weight: 3.4 lbs. (1.5 kg)

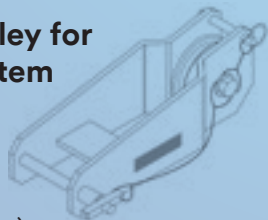

8515631 Cantilever Weight Rack Kit

Use the weight rack in conjunction with the cantilever Rescue System (8512297) if there is not sufficient space for the attendant vehicle. *Weight plates sold separately.*

Weight: 36 lbs. (16.3 kg)

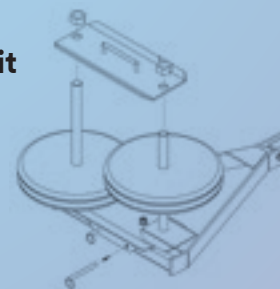

3M™ DBI-SALA®

Pole Hoist System

The Pole Hoist attaches with a carabiner on the universal bracket to a suitable anchor point, allowing you to work in any direction from any angle. It has a unique swivel head that rotates 360 degrees, providing flexibility in both vertical and horizontal confined space entries. Two systems that adjust from either 4 ft.-7 ft. (1.2 m-2.1 m) or 6 ft.-10 ft. (1.8 m-3 m) are available for job site flexibility and to better position the attendant in close working quarters. Custom lengths are also available. Please call us for details.



8530253

Extendable Pole Hoist 6 ft.-10 ft. (1.8 m-3 m)

Extension with swivel head and winch mounting bracket, T-bar leg assembly and hardware/fasteners.

Weight: 14 lbs. (6.4 kg)

8530252 Extendable Pole Hoist

4 ft.-7 ft. (1.2 m-2.1 m).

Weight: 12 lbs. (5.4 kg)

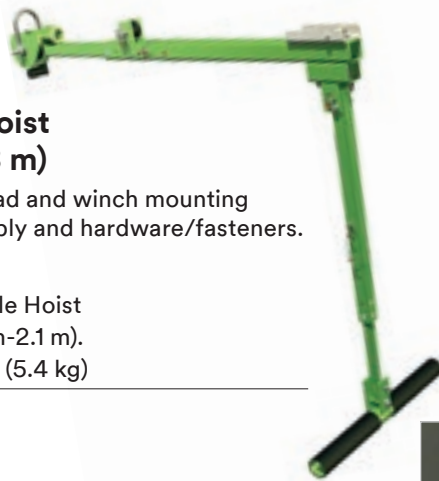

Pole Hoist Accessories

8520777

Clamp-On Anchor for Pole Hoists

Designed to secure to a vertical or horizontal flange up to 6 in. (15.2 cm) thick and provide an anchorage point to connect a pole hoist device to.



2104550

Steel Anchor Plate with D-Ring

This plate anchor offers a compact, reliable attachment to 3/8 in.-1 in. thick plate steel for connecting your lanyard, vertical lifeline system or self-retracting lifeline.



8513330

Carrying Bag

For 6 ft.-10 ft. pole hoist.

8513329 Carrying Bag for 4 ft.-7 ft. pole hoist



Confined Space Rescue

3M™ DBI-SALA®

Portable Fall Arrest Posts

Enhance protection. Maintain mobility. Our Portable Fall Arrest Post makes it possible for up to three workers on top of transformers or other types of vertical platforms with potential fall hazards. It's compact and easy to transport and set up at only 38 lbs. (17.2 kg). The system features a telescopic design and three swiveling anchor points, delivering 360 degrees of protection and mobility. Portable and fixed bases maximize versatility on your job site.

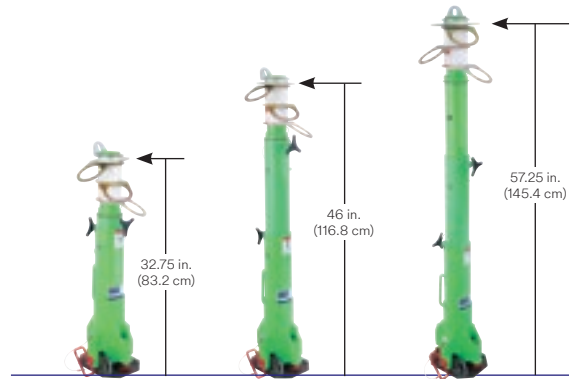

Telescopic design: Overall height can be adjusted from 32.75 in.-57.25 in. (83.2 cm-145.4 cm)

8516691 Portable Fall Arrest Post

- Three independent swiveling tie-off points.
- 360 degrees of protection for three workers.
- Telescopic design; 32-3/4 in.-46 in.-57-1/4 in. (83.2 cm-116.8 cm-145.4 cm).
- Lightweight and durable aluminum construction.
- Leveling screws plumb system on inclines up to 15 degrees.
- Built-in anchor ring for horizontal lifeline attachment.
- Portable and fixed bases provide complete job site versatility.



Weight: 38 lbs. (17.5 kg)

8516693 Rescue Davit Arm for Portable Fall Arrest Post

The optional Rescue Davit Arm assembles easily to our Portable Fall Arrest Post, providing simple and efficient rescue and material handling capabilities. It's made with lightweight aluminum materials for easy transportation and setup.

Weight: 20.5 lbs. (9.3 kg)

8516691 post not included—order separately.

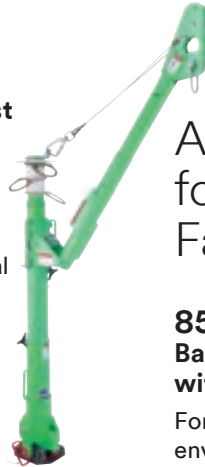

Anchor Bases for Portable Fall Arrest Post

8517412 Bare Steel Uni-Anchor with Tie-Off Anchors

For use in closed environments without chemical or moisture exposure.

Weight: 11.6 lbs. (5.3 kg)



8510816 Weld-On Mounting Plate

Unplated mild steel construction.

Weight: 11.6 lbs. (5.3 kg)



8517413 Incline Adapter with Tie-Off Anchor

Permanently weld to inclined surface.

Weight: 24 lbs. (10.9 kg)



Accessories

8516692 14 in. (356 mm) Anchor Post Extension

Provides option to tie-off one worker at an increased height of 68.5 in. (174 cm)

Weight: 5 lbs. (2.2 kg)



8517565 Carrying Bag

Heavy-duty carrying bag for Portable Fall Arrest Post.



8516997 Uni-Anchor I-Beam Base

Portable anchor clamps to I-beams.

Weight: 56 lbs. (25.5 kg)



3M™ DBI-SALA®

Mechanical Systems

Retrieving incapacitated workers and bringing them to safety makes the mechanical device one of the most critical parts of your rescue system. Choosing the right lifeline type and length are just a few of the options. In some situations, you may need a secondary or backup system, too.

1 Digital Winches

- Man rated 450 lb. (204 kg) capacity.
- Digital usage indicator tracks drum revolutions to determine service intervals.
- Triple redundant braking system for added safety.
- Sealed bearings at all contact points.
- Two gear ratio options of 4:1 and 9:1.
- Power drive option available.
- Three sizes accommodate 70 ft.-300 ft. (21 m-91 m) lengths.
- Cable and rope lifelines with swiveling snap hook and overload indicator.
- Carrying handle for easy transport.
- Corrosion-resistant, zinc-plated steel or anodized aluminum hardware.

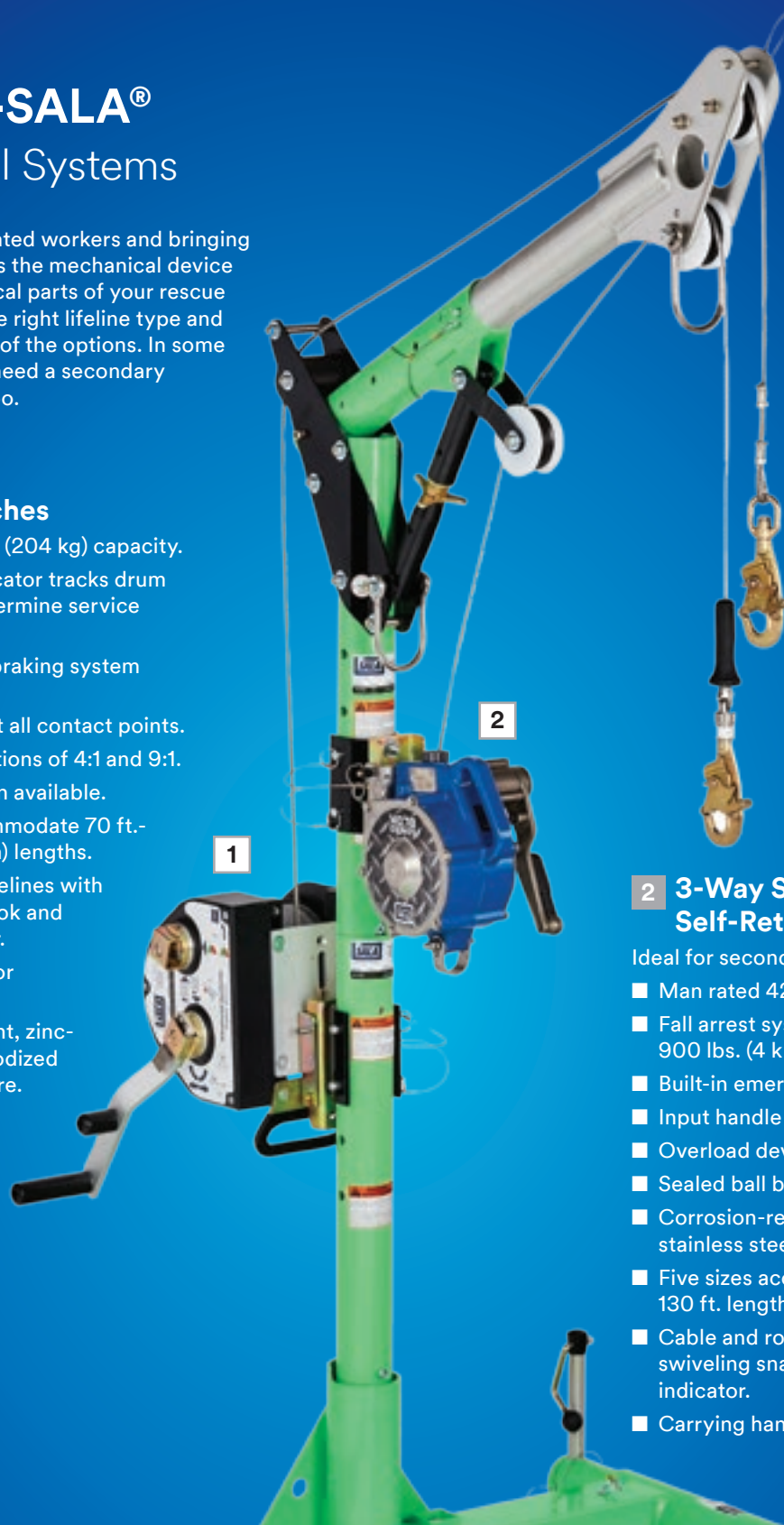

2 3-Way Sealed-Blok Self-Retracting Lifeline

- Ideal for secondary or back-up.
- Man rated 420 lb. (190 kg) capacity.
 - Fall arrest system limits forces to 900 lbs. (4 kN).
 - Built-in emergency retrieval winch.
 - Input handle with primary brake.
 - Overload device in winch drive.
 - Sealed ball bearings.
 - Corrosion-resistant aluminum and stainless steel construction.
 - Five sizes accommodate 30 ft.-130 ft. lengths (9 m-40 m).
 - Cable and rope lifelines with swiveling snap hook and impact indicator.
 - Carrying handle for easy transport.



Salalift™ II Winches

- Man rated 350 lb. (159 kg) capacity.
- Overload clutch.
- Gear ratio of 6:1.
- Free-wheel mode.
- Shielded ball bearings.
- Lengths from 60 ft.-120 ft. (18 m-36.5 m) available.
- Cable and rope lifelines with swiveling snap hook and impact indicator.
- Carrying handle for easy transport.
- Corrosion-resistant construction.
- Quick-mount bracket and carrying bag.

3M™ DBI-SALA® Winches



Digital Winch



Salalift™ II Winch

Drive type	Lifeline type	Mounting bracket	Winch bag	Digital winch	Salalift II Winch	50 ft. (15.2 m)	60 ft. (18 m)	90 ft. (27 m)	120 ft. (36.5 m)	140 ft. (42 m)	190 ft. (58 m)	240 ft. (73 m)	290 ft. (88 m)
Power drive*	Galvanized steel	■		■			8518567	8518568		8518588	8518589	8518610	8518611
	Stainless steel	■		■			8518565	8518566		8518586	8518587	8518608	8518609
	Technora rope	■		■			8518571						
Removable handle	Galvanized steel	■		■			8518560	8518561		8518581	8518582	8518603	8518604
		■	■		■		8102001	8102009	8102005				
	Stainless steel	■		■			8518558	8518559		8518579	8518580	8518601	8518602
		■	■		■		8102003	8102011	8102007				
	Technora rope	■		■			8518564						
		■	■		■		8102050						
Cable model weight						-	30.5 lbs. (13.8 kg)	32.5 lbs. (14.7 kg)	38.5 lbs. (17.5 kg)	40 lbs. (18.4 kg)	43 lbs. (19.5 kg)	50 lbs. (22.6 kg)	53.5 lbs. (19.5 kg)
Technora rope model weight						27 lbs. (12.2 kg)	27 lbs. (12.2 kg)						

The Salalift II Winch includes a mounting bracket and carrying bag.

* Power drive units require Overload Protection Clutch (8512936)—not included.

3-Way Self-Retracting Lifelines



3-Way Sealed-Blok SRL - RSQ

3-Way Ultra-Lok™ SRL

3-Way Sealed-Blok SRL

Cable type	Sealed-Blok	Sealed-Blok without bracket	Sealed-Blok/RSQ	Ultra-Lok	30 ft. (9.1 m)	50 ft. (15.2 m)	85 ft. (25.9 m)	130 ft. (39.6 m)	175 ft. (52.5 m)
Galvanized steel	■				3400853	3400923	3400871	3400976	
		■			3400850	3400920	3400870	3400975	3400660
			■			3400940	3400910	3401002	
				■		3501102			
Stainless steel	■				3400858	3400926	3400882	3400987	
		■			3400852	3400922	3400874	3400979	3400661
			■			3400942	3400912	3401004	
				■		3501103			

3M™ DBI-SALA®

Winch Brackets and Accessories

8518506 Adjustable Ladder Bracket

Designed to allow use of the ladder section(s) 8518507 with various base, sleeve and mast options. Installs over mast/extension.



8518507 8 ft. Ladder Section

Complete with connector channels and positive pin locks. Can be connected to additional ladders (up to five sections) for a maximum length of 32 ft. (9.75 m).

8518508 4 ft. Ladder Section



8510207 Winch/SRL Adapter with Flat Back

To attach 3M DBI-SALA Winch/SRL to structures.



8516824 Quick-Release Mounting Bracket

For Upper and Lower Masts.



8517567 Padded Carrying Bag

For digital winch.



8512936 Overload Protection Clutch

Features a maximum working load of 450 lbs.

8512935 Maximum working load of 250 lbs.



1001210 Retrieval Wristlets

Rescue/retrieval design is ideal for connection to victim's wrists for narrow extractions. Yoke wristlets attached to Y-lanyard with D-ring at end x 2 ft. (0.6 m)

1001220 Attached with an O-ring at one end x 18 in. (0.46 m)



1231460 Y-Lanyard

Rescue/retrieval design ideal for use with harness incorporating shoulder D-rings. Spreader bar with snap hooks at ends, D-ring at center x 2 ft. (0.6 m)

1231470 Y-Lanyard without spreader bar x 2 ft. (0.6 m)





Rescue and Descent

Always be
rescue-ready.



When the clock starts ticking, you need a rescue plan you can count on to rescue you quickly and efficiently. The 3M™ DBI-SALA® Self-Rescue Device is your rescue plan: a flexible product that attaches to your current safety harness and allows you to lower yourself to safety in the event of a fall from height. This simple, fast and effective rescue plan minimizes risk for you, your coworkers and emergency response personnel.



Choosing rescue and descent systems

The type of job site, anchor location, working load and limit, and ease of use are some important considerations when choosing the appropriate rescue and descent system. A single rescue system cannot efficiently handle every scenario, performing well for one application but not another. Some rescue systems are easy to use for one application, while others require more skill but can be adapted for use in multiple situations.

3M™ DBI-SALA®

Self-Rescue Device

With the 3M DBI-SALA Self-Rescue Device, you can work at height without worrying about hanging in your harness for an extended period of time after an arrested fall event. Instead of wondering how long it will take to alert others to your fall, or how long before trained rescuers can gather the appropriate equipment to get you down, you can simply avoid all that and free yourself.



Virtually universal attachment

Now you can add the benefits of a self-rescue device to your safety equipment without the added expense of purchasing a new harness. The Self-Rescue Device retrofits to virtually any safety harness, so you can keep wearing the one you're most comfortable using.

1 Easily accessible primary release cord

2 EZ-Link™ D-Ring

The EZ-Link Stand-Up D-Ring provides a simple, fast connection point for your lanyards or personal Self-Retracting Lifelines (SRLs). This technology is tested to speed up connection and disconnection times by up to 80%.

3 Molded padding

Protects the bag from additional wear and tear when personal SRLs are worn.

4 Color-coded and reflective elements

Direct the eyes and provide greater visibility, even in dark situations.

5 Assisted-rescue ring and 3M DBI-SALA Rescue Pole

The assisted-rescue ring allows for remote access and deployment by a colleague. The Rescue Pole (sold separately) extends your reach and easily hooks into the ring, providing for a safe, efficient assisted rescue.

6 50-and 100-foot lengths

The Self-Rescue Device gives you more flexibility and freedom to work at height worry-free.



Model shown
3320030



Sealed descent device and rope spool

When working in harsh environments, you can't afford to worry about equipment failure. The Self-Rescue Device is designed and tested to withstand the toughest conditions.



3M™ DBI-SALA® Self-Rescue Device

3320031

Self-Rescue 100

Height: 19 in., Width: 7 in.,
Depth: 2-1/2 in., 100 ft. of 5.5 mm rope.

3320030

Self-Rescue 50

Height: 19 in., Width: 7 in.,
Depth: 2-1/2 in., 50 ft. of 5.5 mm rope.



Lightweight,
low profile
design
minimizes
impact on
user's motion.
Unit width: 7 in.



3320037

Self-Rescue Training Device

This 30-foot trainer device simulates a realistic fall rescue experience, allowing you to educate your team on the use of the product. It's easy to rewind the rope on-site, so you can train your team up to 20 times before recertification of the device will be required.

Height: 19 in., Width: 7 in.,
Depth: 2-1/2 in., 30 ft. of 5.5 mm rope.

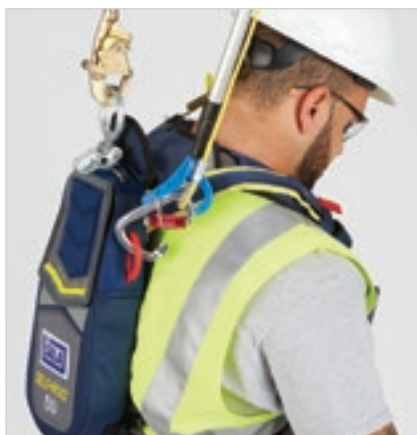

8900299

Rescue Pole

Kit includes bag, rescue pole,
carabiner and tagline.
Bag length: 28-1/2 in.
Width: 6 in.
Depth: 2 in.
Weight: 2 lbs.
Pole extends to 8 ft. 8 in.





Model shown
3400930



Model shown
3504550

3M™ DBI-SALA® RSQ

Dual-Mode Descent

Our exclusive RSQ Dual-Mode Descent is a built-in rescue operation feature allowing you to work and rescue with the same equipment. That means a lower cost of ownership without compromising on safety. It includes:

- Standard fall arrest mode
- Automatic descent mode
- Remote/assisted descent activation options
- As featured on Sealed-Blok RSQ and Ultra-Lok™ RSQ Self-Retracting Lifelines

Sealed-Blok RSQ Self-Retracting Lifelines

3400932 Sealed-Blok RSQ SRL

50 ft. (15 m) of 3/16 in. (5 mm) stainless steel wire rope with swivel snap hook, RSQ dual-mode, anchorage carabiner, 4 ft. (1.2 m) cable tie-off adapter.

3400886 Sealed-Blok RSQ SRL

85 ft. (25.5 m) of 3/16 in. (5 mm) stainless steel wire rope with swivel snap hook, RSQ dual-mode, anchorage carabiner, 4 ft. (1.2 m) cable tie-off adapter.

3400991 Sealed-Blok RSQ SRL

130 ft. (39 m) of 3/16 in. (5 mm) stainless steel wire rope with swivel snap hook, RSQ dual-mode, anchorage carabiner, 4 ft. (1.2 m) cable tie-off adapter.

Ultra-Lok RSQ Self-Retracting Lifelines

3504550 Ultra-Lok RSQ SRL

50 ft. (15.2 m) of 3/16 in. (5 mm) galvanized steel wire rope with swivel snap hook and RSQ dual-mode.

3504552 Ultra-Lok RSQ SRL

50 ft. (15.2 m) of 3/16 in. (5 mm) stainless steel wire rope with swivel snap hook and RSQ dual-mode.

Rescue and Descent

Fall Arrest Mode



Assisted rescue by pole



Assisted rescue by hand

Automatic Descent Mode



Self-rescue/descent



These assisted rescue options "engage" the descent mode. Traditional assisted rescue operations may also be conducted.



3M™ DBI-SALA® Sealed-Blok RSQ SRL Assisted Rescue Accessories

3500201
Remote Anchoring System Pole
6-12 ft. (1.8-3.6 m) with Assisted Rescue Tool.

3500202
Remote Anchoring System Pole
8-16 ft. (2.4-4.8 m) with Assisted Rescue Tool.

3500200
Assisted Rescue Tool only
(If you already have a System Pole.)

Ultra-Lok™ RSQ SRL Assisted Rescue Accessories

3500101
Remote Anchoring System Pole
6-12 ft. (1.8-3.6 m) with Assisted Rescue Tool.

3500102
Remote Anchoring System Pole
8-16 ft. (2.4-4.8 m) with Assisted Rescue Tool.

3500100
Assisted Rescue Tool only
(If you already have a System Pole.)

3M™ DBI-SALA® Rollgliss™ R550 Rescue and Descent Device

Keep rescues simple with the Rollgliss R550. It's among the lightest, most compact, and easy-to-use designs in its class. It offers the choice of rescue, evacuation, or the versatility of assisted rescue with lifting capabilities. When every second counts, count on the R550.



1 Drill adapter

Provides a mechanical option to raise a victim. Compatible with most cordless hand drills.

2 Cast aluminum housing

Lightweight and extremely durable cast housing.

3 Bi-directional hub

Rope descends from either side which brings one hook up as the other goes down, allowing for immediate use after each descent.

4 Anchorage

Used to anchor the device with either a carabiner or sling.

5 Integrated rope ears

Allows for greater descent speed control in assisted rescues.

6 Dual brakes

Automatic descent with added security, safety and peace of mind.

7 Durable rope

3/8 in. (9.5 mm) static kernmantle Rope. NFPA - L rated for durability.

8 Lifeline hook

Patented self-locking snap hook is industry preferred and compatible with our Remote Anchoring System for remote rescue capabilities.



Model shown
3327100



Super tough nylon makes the R550 rescue wheel lightweight and durable. Its ergonomic design gives the user a better grip and more control.

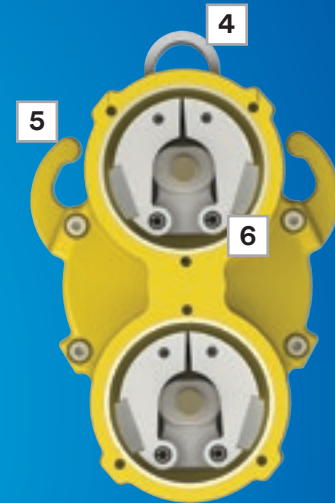

Extremely compact

The R550 is the lightest, most compact unit in its class.

Multiple length options

Lengths between 50 ft. (15 m) and 500 ft. (152 m). Rope bag included with each model.

Two-person capacity

Can be used from heights up to 1,640 ft. (500 m) for one user at 310 lbs. (141kg) or 575 ft. (175 m) for two users totaling 620 lbs. (282 kg).

Optional Ladder Bracket

Sold separately (3320014).

3M™ DBI-SALA® Rollgliss R550 Rescue Units

Includes carabiner (two), 4 ft. (1.22 m) anchor sling and rope bag.

Part #	Length	Weight
3327050	50 ft. (16 m)	11.95 lbs. (5.42 kg)
3327100	100 ft. (31 m)	13.85 lbs. (6.28 kg)
3327150	150 ft. (46 m)	15.75 lbs. (7.14 kg)
3327200	200 ft. (61 m)	17.65 lbs. (8.01 kg)
3327275	275 ft. (84 m)	20.50 lbs. (9.30 kg)
3327300	300 ft. (92 m)	21.45 lbs. (9.73 kg)
3327325	325 ft. (100 m)	22.40 lbs. (10.16 kg)
3327350	350 ft. (107 m)	23.85 lbs. (10.82 kg)
3327400	400 ft. (122 m)	25.75 lbs. (11.68 kg)
3327450	450 ft. (137 m)	27.65 lbs. (12.54 kg)
3327500	500 ft. (153 m)	29.55 lbs. (13.40 kg)



Rollgliss R550 Escape Units

Includes carabiner (two), 4 ft. (1.22 m) anchor sling and rope bag.

Part #	Length	Weight
3325100	100 ft. (31 m)	12.75 lbs. (5.78 kg)
3325200	200 ft. (61 m)	16.55 lbs. (7.51 kg)
3325275	275 ft. (84 m)	19.40 lbs. (8.80 kg)
3325300	300 ft. (92 m)	20.35 lbs. (9.23 kg)

Rollgliss R550 Rescue Units with Case

Includes edge protector, 4 ft. (1.22 m) anchor sling (two), 2.5 ft. (0.76 m) anchor sling, pulley, rope grab, carabiner (three), rope bag, and humidity case.

Part #	Length	Weight
3326100	100 ft. (31 m)	35.3 lbs. (16.01 kg)
3326300	300 ft. (92 m)	42.9 lbs. (19.46 kg)
3326350	350 ft. (107 m)	44.8 lbs. (20.32 kg)



9508289

Fully sealed case provides 10 year minimum storage life. External humidity indicator allows user to inspect the seal without opening case.

Accessories

9506162
Rope Bag



3620005
4 ft. (1.22 m)
Anchoring
Sling



3620004
2.5 ft. (.76 m)
Anchoring
Sling



3320003
Edge Protector
with Carabiner

9504733
Pulley



AC202D/O
Rope Grab



8900299
Rescue Pole



3320014
Ladder Bracket



9508289
Humidity Case



2000112
Carabiner
1 1/16 in.
(1.75 cm) gate



2000114
Carabiner
2 3/16 in.
(5.56 cm) gate



Rescue and Descent

3M™ DBI-SALA® Rollgliss™ R350 Rescue and Positioning Device

The Rollgliss R350 System provides efficient hauling, but more importantly, very controlled lowering (a finger and thumb are all that is required to hold a load).

8902004 Rollgliss R350 Rescue System, 50 ft. travel/200 ft. of 3/8 in. rope (15.25 m/61 m), 3:1 ratio with pulleys, rope control device, anchor strap, carabiner and carrying bag

8902006 Rollgliss R350 Rescue System, 100 ft. travel/400 ft. of 3/8 in. rope (30.5 m/122 m), 3:1 ratio with pulleys, rope control device, anchor strap, carabiner and carrying bag



Other lengths available in 10 ft. (3 m) increments. Accessories including 2:1, 4:1 and 5:1 pulleys are also available.

Rollgliss Descender

Help personnel make a quick, safe escape with the Rollgliss Descent Device. Either vertical or sloped descent models are available to provide complete versatility and flexibility for any job site or work environment.

- Simple design for easy installation and use.
- No power source or special skills or tools required.
- Simply connect to harness and step off structure for evacuation.
- Use repeatedly without factory servicing after user inspection.
- Corrosion-resistant construction for maximum durability.
- Wire rope lifeline for added durability in extreme environments.
- Automatic retraction.



Rollgliss Rescue Positioning Device

Service buildings, bridges and dams with the simple safety of the Rollgliss Rescue Positioning Device. Featuring a speed-sensing lock that allows you to manually lock off the device once you reach a work level, it serves both as a rescue system and has features for raising, lowering and positioning during normal work activities. Either the user or a second standby worker can operate it for enhanced versatility.

- Pre-rigged for quick and easy installation and use.
- No special tools, power source or extensive skills needed.
- Built-in brake stops a fall should user lose control.
- Lock-out mechanism allows user to stop/start anywhere.
- 3:1 or 4:1 lifting ratio configurations available.
- Durable, corrosion-resistant construction.

3602050 Rollgliss Rescue Positioning Device, 50 ft. travel/260 ft. of 3/8 in. rope (15.25 m/79.3 m), 4:1 ratio with pulleys, rope anchor straps, two carabiners and carrying bag

3602100 Rollgliss Rescue Positioning Device, 100 ft. travel/510 ft. of 3/8 in. rope (30.5 m/155.5 m), 4:1 ratio with pulleys, rope anchor straps, two carabiners and carrying bag



3302002 Rescue Sling

Descent type	Lifeline material	Low or high speed	Travel distance	
			115 ft. (35 m)	200 ft. (61 m)
Vertical	Galv	Low	3303000	
		Low		3303017
	SS	Low	3303002	
		Low		3303018
Sloped	Galv	Low	3303001	3303021
		High		3303015
	SS	Low	3303003	3303019
		High		3303016

Sloped low speed models also include linkage, guide cable sleeve and suspension bars. Sloped high speed models include linkage, braking trolley and suspension bars.

3M™ DBI-SALA® Rollgliss

R250 Rescue Kit

8900292

The system is simple, yet completely safe and efficient. It enables the rescuer to remove a person from danger without putting themselves at risk by descending to them.

- 33 ft. (10 m) travel length.
- Kit is easily transported in backpack-style bags.
- Takes only a few minutes to set up and perform a rescue.
- Rescue is performed safely from above victim.
- Kit includes all necessary components for safe rescue.

8900293 Rollgliss Rescue Kit with 66 ft. (10 m) travel length

8900294 Rollgliss Rescue Kit with 99 ft. (30 m) travel length



3601490

Sealed Tension Limiter

Unique device attaches to man-riding system in-line between the person and the raising/lowering line to warn operator and limit forces on an entangled worker.

- Limits loading on person to 400 lbs. (182 kg) to prevent severe injury when entangled.
 - High visibility line is easy to see should deployment occur.
 - Portable and lightweight for easy transport and quick setup.
- Always use a separate back-up fall protection device with this system.



8516294

Rollgliss Rescue Ladder

The Rollgliss Rescue Ladder provides a way to assist rescue after a fall has occurred. It can be anchored to a structure and dropped down to the victim's level, so they can climb either up or down to safety. The ladder can be used by any able-bodied victim not incapacitated by the fall.

- Available in 8 ft. (2.4 m) sections.
- Extra sections can be added together for longer length.
- Includes three carabiners for attachment.

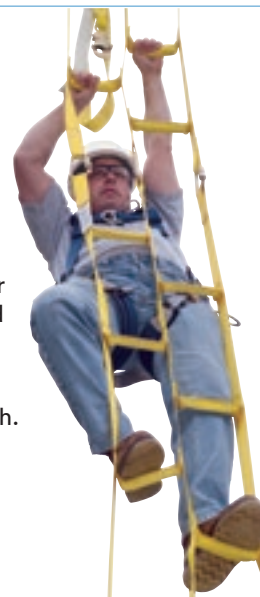

8516316

Rollgliss Rescue Ladder Anchor

Accessory plate for mounting rescue ladder to a davit arm or single anchorage point.



Rescue and Descent

3M™ DBI-SALA® Rollgliss™

Technical Rescue Line

Find everything you need for rigging—from single descent systems to flying foxes—in our Rollgliss Technical Rescue line. It complements our already-established line of industrial rescue systems, including pre-rigged rescue kits like the Rollgliss R350, Rollgliss R550 and more.

Descenders

8700388

Double Stop Descender Range

Anodized gold/blue aluminum, suits 12.5-13.0 mm rope

8700387 Anodized gold aluminum, suits 10.5-12mm rope



Anchor Straps

3699998

Anchor Straps

Minimum breaking strength of 7,875 lbs. (35 kN), 1 in. (25 mm) round webbing, 1.5 ft. (500 mm).

3699952 3 ft. (1000 mm)

3699953 5 ft. (1500 mm)

3699954 6.5 ft. (2000 mm)

3699997 10 ft. (3000 mm)



2103189

Fisk Descender

- Gentle flow for 19 in. (48.3 cm) of lifeline to pass through the descender.
- Large radius for smoother descent and less wear to lifeline.
- Reduction in rope hocking and torsional twist.
- Durable 304 stainless steel construction.



Rigging plates

2189983

Rigging Plate Range

Large rectangular, anodized gold, 14 rigging points.

2189996 Large rectangular, anodized gold, 14 rigging points

2189997 Small triangle, anodized gold, 6 rigging points

2189998 Oval with rubber ring, anodized gold, 10 rigging points

2189999 Paw-shaped, anodized gold, 5 rigging points



2189996



2189997



2189998



2189999

3M™ DBI-SALA®

Carabiners and Quick Links

Carabiners



8700561



8700167



8700168



8700201



2000172



8700200



8700198



2000171



2000117



2000114



2000025



Quick Links



9509238



8700425

	Part #	Description	Material	Gate opening	Locking mechanism	Minimum breaking strength
Rescue	8700561	Oval carabiner with pin captive eye	Steel	5/8 in. (16 mm)	Screw gate	5,625 lbs. (25 kN)
	8700167	Oval carabiner	Alum	3/4 in. (19 mm)	Screw gate	5,000 lbs. (22 kN)
	8700168	Small offset D rescue carabiner	Alum	5/8 in. (16 mm)	Screw gate	6,750 lbs. (30 kN)
	8700201	Large offset D rescue carabiner	Steel	1.13 in. (29 mm)	Screw gate	12,150 lbs. (54 kN)
	2000172	Large offset D rescue carabiner	SS	1.13 in. (29 mm)	Autolock, triple action	7,875 lbs. (35 kN)
	8700200	Small offset D rescue carabiner	Alum	5/8 in. (16 mm)	Autolock, triple action	6,750 lbs. (30 kN)
	8700198	Medium offset D rescue carabiner	Alum	7/8 in. (22 mm)	Screw gate	8,100 lbs. (36 kN)
	2000171	Medium offset D rescue carabiner	Alum	1 in. (25 mm)	Autolock, double action	5,625 lbs. (25 kN)
ANSI	2000117	Medium offset D fall arrest carabiner, captive eye, ANSI rated	Steel	3/4 in. (19 mm)	Autolock, double action	5,000 lbs. (22 kN)
	2000114	Extra large parabiner fall arrest carabiner, captive eye, ANSI rated	Steel	2.13 in. (54 mm)	Autolock, double action	7,875 lbs. (35 kN)
	2000025	Medium parabiner fall arrest carabiner, ANSI rated	Alum	3/4 in. (19 mm)	Autolock, triple action	5,000 lbs. (22 kN)
Quick links	9509238	Delta style quick link	Steel	1/4 in. (7 mm)	Manual closing screw	10,125 lbs. (45 kN)
	8700425	D-style quick link	Steel	3/8 in. (10 mm)	Manual closing screw	10,125 lbs. (45 kN)

Rescue and Descent

3M™ DBI-SALA® Ropes



Part #	Description	Construction	Length
8705115	Rope lifeline finished both ends with a thimble	7/16 in. (11 mm) Static kernmantle, poly/nylon	50 ft. (15 m)
8705116	Rope lifeline finished both ends with a thimble	7/16 in. (11 mm) Static kernmantle, poly/nylon	100 ft. (30 m)
8705117	Rope lifeline finished both ends with a thimble	7/16 in. (11 mm) Static kernmantle, poly/nylon	200 ft. (60 m)
8705118	Rope lifeline finished both ends with a thimble	7/16 in. (11 mm) Static kernmantle, poly/nylon	325 ft. (100 m)
8705119	Rope lifeline finished both ends with a thimble	7/16 in. (11 mm) Static kernmantle, poly/nylon	410 ft. (125 m)
8705120	Rope lifeline finished both ends with a thimble	7/16 in. (11 mm) Static kernmantle, poly/nylon	650 ft. (200 m)
8705122	Rope lifeline finished both ends with a thimble	1/2 in. (13 mm) Static kernmantle, poly/nylon	50 ft. (15 m)
8705123	Rope lifeline finished both ends with a thimble	1/2 in. (13 mm) Static kernmantle, poly/nylon	100 ft. (30 m)
8705124	Rope lifeline finished both ends with a thimble	1/2 in. (13 mm) Static kernmantle, poly/nylon	200 ft. (60 m)
8705125	Rope lifeline finished both ends with a thimble	1/2 in. (13 mm) Static kernmantle, poly/nylon	325 ft. (100 m)
8705126	Rope lifeline finished both ends with a thimble	1/2 in. (13 mm) Static kernmantle, poly/nylon	410 ft. (125 m)
8705127	Rope lifeline finished both ends with a thimble	1/2 in. (13 mm) Static kernmantle, poly/nylon	650 ft. (200 m)
8700600	Sewn loop personal chest prusik	1/4 in. (6 mm) Kernmantle prusik cord, poly/nylon	1.7 ft. (0.52 m)
8700601	Sewn loop personal chest prusik	1/4 in. (6 mm) Kernmantle prusik cord, poly/nylon	3.9 ft. (1.2 m)
8700602	Sewn loop purcel	1/4 in. (6 mm) Kernmantle prusik cord, poly/nylon	5.6 ft. (1.7 m)
8700603	Sewn loop prusik for foot end of a litter	1/4 in. (7 mm) Kernmantle prusik cord, poly/nylon	3 ft. (0.9 m)
8700604	Sewn loop prusik for head end of a litter	1/4 in. (7 mm) Kernmantle prusik cord, poly/nylon	5.6 ft. (1.7 m)
8700605	Sewn bound loop prusik medium	5/16 in. (8 mm) Kernmantle prusik cord, poly/nylon	1.3 ft. (0.4 m)
8700606	Sewn bound loop prusik medium	5/16 in. (8 mm) Kernmantle prusik cord, poly/nylon	1.3 ft. (0.4 m)
8700607	Sewn bound loop prusik medium	5/16 in. (8 mm) Kernmantle prusik cord, poly/nylon	1.3 ft. (0.4 m)

3M™ DBI-SALA® Pulleys

Rigging & Prusik-Minding Pulleys

Part #	Style	Material	Diameter	Suits rope
8700012	Single	Alum	1.5 in. (40 mm)	Up to 7/16 in. (11 mm)
8700018	Single	Alum	2 in. (50 mm)	Up to 1/2 in. (13 mm)
8700014	Double	Alum	2 in. (50 mm)	Up to 1/2 in. (13 mm)
8700017	Triple	Alum	2 in. (50 mm)	Up to 1/2 in. (13 mm)
8700021	Single, double ended	Alum	2 in. (50 mm)	Up to 1/2 in. (13 mm)
8700015	Double, double ended	Alum	2 in. (50 mm)	Up to 1/2 in. (13 mm)
8700528	Triple, double ended	Alum	2 in. (50 mm)	Up to 1/2 in. (13 mm)
8700013	Prusik minding single	Alum	1.5 in. (40 mm)	Up to 7/16 in. (11 mm)
8700022	Prusik minding single	Alum	2 in. (50 mm)	Up to 1/2 in. (13 mm)



8700012



8700018



8700014

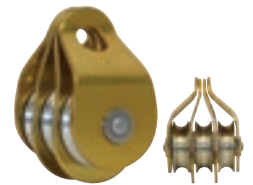

8700017



8700021



8700015



8700528



8700013



8700022

Transport Pulleys

Part #	Style	Material	Diameter	Suits rope
8700053	Tyrolean "T"	Alum	3 in. (80 mm)	Up to 15/16 in. (24 mm)
8700057	Tyrolean "V"	Alum	2.25 in. (60 mm)	Up to 1/2 in. (13 mm)
8700039	Knot passing	Alum	3 in. (80 mm)	7/16 in.-3 in. (11-80 mm)



8700053



8700057



8700039

Rescue and Descent

3M™ DBI-SALA® Rollgliss™ Haul Kits

Rollgliss Haul Kits provide a pre-rigged 4:1 or 6:1 raising and lowering system with integrated progress capture cams, designed for personnel rescue and positioning. They are available in three models with either manual or automatic locking/unlocking cams providing a safe and efficient progress capture system.

8701100

Micro Haul Kit

Mechanical advantage 6:1, working load limit of 660 lbs. (300 kg), 6.5 ft. (2 m) length of 5/16 in. (8 mm) rope.

8701101 10 ft. (3 m) length

8701102 13 ft. (4 m) length



8702098

Manual Lock Haul Kit

Mechanical advantage 4:1, working load limit of 660 lbs. (300 kg), 33 ft. (10 m) length of 7/16 in. (11 mm) rope.

8702099 66 ft. (20 m) length

8702100 98 ft. (30 m) length



8704104

Auto Lock Haul Kit

Mechanical advantage 4:1, working load limit of 660 lbs. (300 kg), 33 ft. (10 m) length of 7/16 in. (11 mm) rope.

8704105 50 ft. (15 m) length

8704107 100 ft. (30 m) length

8704108 130 ft. (39 m) length

8705104 6:1, 33 ft. (10 m) length

8705105 6:1, 46 ft. (14 m) length



Accessories

1270035

Rope Protection – Synthetic

Canvas wrap around with one rigging point.



8700141

Rope Protection – Mechanical

Powder coat aluminum for man-made edges with eight rigging points on each bay.

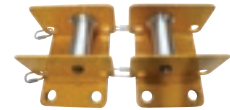

8700142

Rope Protection – Mechanical

Anodized aluminum for natural surfaces with four rigging points.

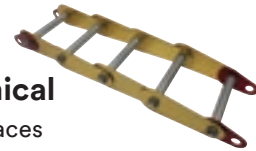

8700302

Rope Protection – Mechanical

Anodized aluminum for man-made and natural surfaces with four end quick rigging points.



8700224

Rope/Gear Bag

3,660 ci. (25 L) PVC bag. Fits 980 ft. x 7/16 in. (300 m x 11 mm) or 655 ft. x 1/2 in. (200 m x 13 mm). (XLarge)



8700225 Small. 1,525 ci (25 L). 164 ft. x 7/16 in. (50 m x 11 mm) or 82 ft. x 1/2 in. (25 m x 13 mm)

8700222 Medium. 2,440 ci (25 L). 328 ft. x 7/16 in. (100 m x 11 mm) or 164 ft. x 1/2 in. (50 m x 13 mm)

8700223 Large. 3,035 ci (25 L). 655 ft. x 7/16 in. (200 m x 11 mm) or 328 ft. x 1/2 in. (100 m x 13 mm)

1234081

Adjustable Rope Positioning Lanyard

Steel carabiner on one end and rope adjuster with steel carabiner at the other end x 8 ft. (2.4 m).

1234080 Aluminum carabiner on one end and rope adjuster with aluminum carabiner at the other end x 8 ft. (2.4 m)



3M™ DBI-SALA® Ascenders

8700523

Ergonomic Hand Ascender

Left-hand with rope size of 7/16 in.-1/2 in. (10.5 mm-13 mm).

8700524 Right-hand with rope size of 7/16 in.-1/2 in. (10.5 mm-13 mm)

8900249 Rollgliss™ 13 mm Rope Control Device



8700522

Retrofit Chest Ascender

Anodized gold aluminum, retrofit with rope size of 7/16 in.-1/2 in. (10.5 mm-13 mm)



1219006

Single-Leg Foot Loop

Webbing. Adjustable up to 6 ft. (1.8 m)

1219007 Twin-Leg Foot Loop. Webbing. Adjustable up to 6 ft. (1.8 m)



1219020

5-Step Etrier

Webbing. 6 ft. (1.8 m).



Swivel & Gear Roll

8700144

Swivel

Minimum breaking strength 9,000 lbs. (40 kN).



8700397

Gear Roll

PVC gear roll, 4 gear pockets, 7 carabiner hooks. (Small)



8700398

Gear Roll

PVC gear roll, 14 gear pockets, 20 carabiner hooks. (Large)





Netting and Guardrails

**Grab the
right netting
or guardrail.
It'll return
the favor.**



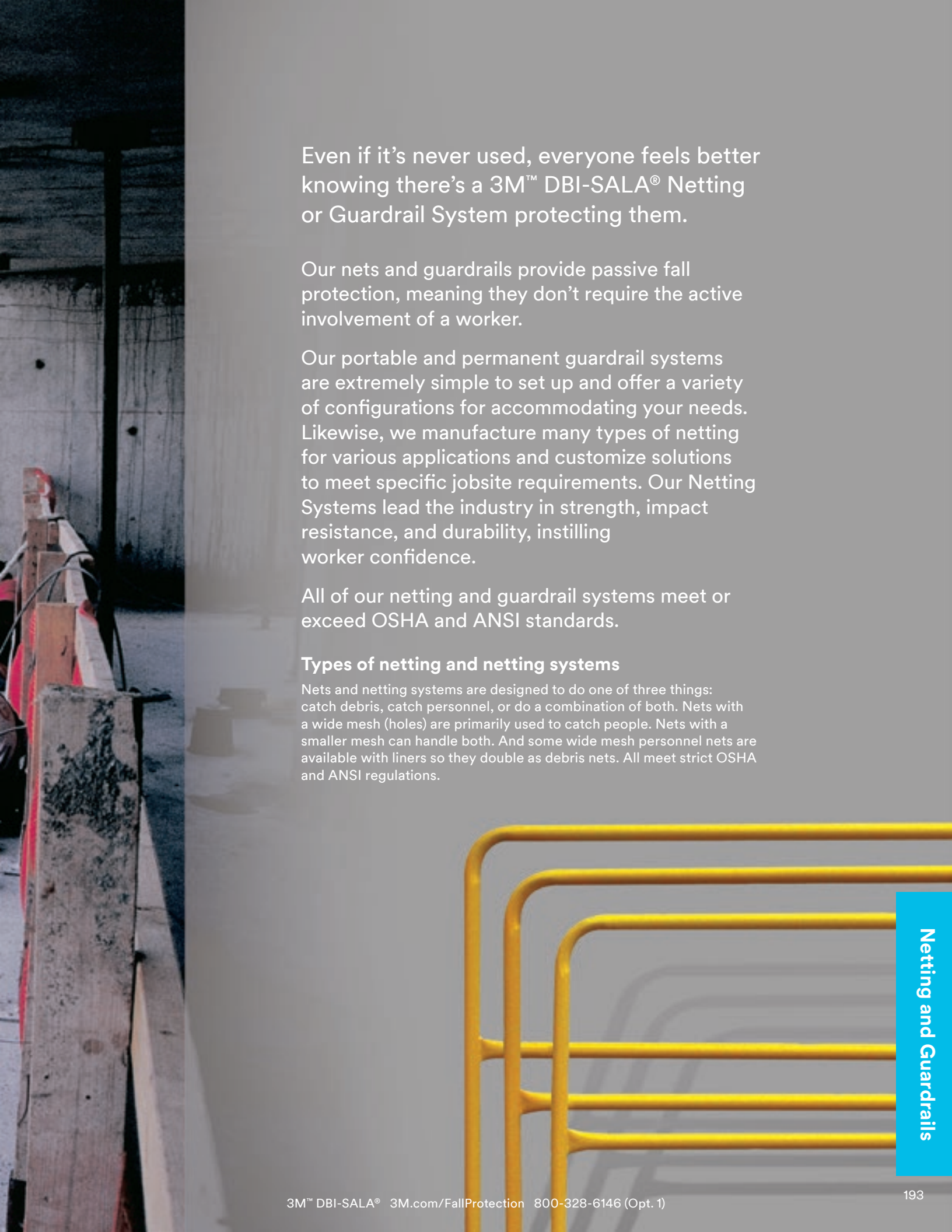

Even if it's never used, everyone feels better knowing there's a 3M™ DBI-SALA® Netting or Guardrail System protecting them.

Our nets and guardrails provide passive fall protection, meaning they don't require the active involvement of a worker.

Our portable and permanent guardrail systems are extremely simple to set up and offer a variety of configurations for accommodating your needs. Likewise, we manufacture many types of netting for various applications and customize solutions to meet specific jobsite requirements. Our Netting Systems lead the industry in strength, impact resistance, and durability, instilling worker confidence.

All of our netting and guardrail systems meet or exceed OSHA and ANSI standards.

Types of netting and netting systems

Nets and netting systems are designed to do one of three things: catch debris, catch personnel, or do a combination of both. Nets with a wide mesh (holes) are primarily used to catch people. Nets with a smaller mesh can handle both. And some wide mesh personnel nets are available with liners so they double as debris nets. All meet strict OSHA and ANSI regulations.

Netting and Guardrails

Choosing a netting system

Look for quality in these features when selecting netting.

Quality material

3M™ DBI-SALA® Netting is rot-proof, mildew-proof and has UV protection for longer lasting service. While typical netting materials are polypropylene and nylon, we only use nylon. That's because it's 47% stronger than polypropylene, providing a softer catch while resisting chafing and abrasion. Flame-retardant protection can be applied at the factory for added safety and long wear.

Adjustability

Our patented Adjust-A-Net™ System is the only personnel net on the market that can be adjusted to fit the work area.

Mesh sizes and liners

Meshes are available in many sizes and strengths, depending on the job. Some nets come with liners, so they catch both personnel and debris. The most common debris net mesh size is 1/8 in. (3 mm). A typical personnel net mesh size is 3-1/2 in. (87.5 mm). The diamond-shaped design dissipates strain throughout the net.

Anchoring points and ease of installation

Our netting systems are available with the related cable and hardware for installation to steel or concrete. They're lightweight and easy to handle for fast, safe installation and shifting from floor to floor.

Snap hooks

Featuring a staggered system of lashed-in snap hooks, our netting systems allow for quick and easy connections.

Additional size configurations, hardware kits and accessories are available. For more information, contact customer service at 3mfallprotection@mmm.com.



Personnel/Debris Nets

3M™ DBI-SALA® Border Guard™ System

Conveniently and economically enhance confidence and productivity at your building site. This exclusive system is the first lightweight debris/personnel system made for rigging nets around the perimeter of new concrete buildings. It allows single floor attachment for closer protection at the pour level. Unlike alternative systems, it comes in convenient units and installs with sturdy hardware that's half the weight of the old style net systems.

- Meets ANSI and OSHA standards for debris containment and for falls by personnel of 10 ft. or less.
- Easily installed, from one level without a crane or special equipment.
- Non-destructive floor clamps easily attach to concrete slabs.
- Nets extend 10 ft. (3 m) out from floor edge.

Border Guard Starter Kit

1 ea. net, 4 in. (10 cm) black mesh with 1/8 in. (3.2 mm) debris liner and snap hooks, 2 ea. floor clamps, 2 ea. 10 ft. (3 m) arms, 2 ea. 1/2 in. (12.7 mm) shackles, 8 ea. bolts, 6 ea. cable assemblies, 2 ea. straps with cam buckles.

10 ft. x 10 ft. (3 m x 3 m)	10 ft. x 15 ft. (3 m x 4.6 m)	10 ft. x 25 ft. (3 m x 7.6 m)	15 ft. x 30 ft. (3 m x 9 m)
4100089	4100091	4100006	4100151

Also available are starter kits with column bases. 2 arms, 2 concrete/I-beam column clamps, net and hardware.

4100047 Starter Kit, 10 ft. x 25 ft. (3 m x 7.6 m),
column base

4100155 Starter Kit, 10 ft. x 30 ft. (3 m x 9 m),
column base

4100005

Border Guard Corner Kit

1 ea. 12 ft. x 12 ft. x 17 ft. (3.6 m x 3.6 m x 5.2 m) net, 4 in. (10 cm) black mesh with 1/8 in. (3.2 mm), debris liner and snap hooks, 1 ea. cable assembly.

4100157 Hardware Pack

Border Guard Add-On Kit

1 ea. net, 4 in. (10 cm) black mesh with 1/8 in. (3.2 mm) debris liner and snap hooks, 2 ea. floor clamps, 1 ea. 10 ft. (3 m) arm, 1 ea. 1/2 in. (12.7 mm) shackle, 4 ea. bolts, 3 ea. cable assemblies, 1 ea. strap with cam buckle.

10 ft. x 10 ft. (3 m x 3 m)	10 ft. x 15 ft. (3 m x 4.5 m)	10 ft. x 25 ft. (4.5 m x 9 m)	10 ft. x 30 ft. (6 m x 12 m)
4100092	4100093	4100007	4100153

Also available are Add-On Kits with column bases. 1 arm, 1 concrete/I-beam column clamp, net and hardware.

4100141 Add-On Kit, 10 ft. x 10 ft. (3 m x 3 m),
column base

4100140 Add-On Kit, 10 ft. x 15 ft. (3 m x 4.6 m),
column base

4100139 Add-On Kit, 10 ft. x 25 ft. (3 m x 7.6 m),
column base

4100156 Add-On Kit, 10 ft. x 30 ft. (3 m x 9 m),
column base



Border Guard Stanchion

Netting and Guardrails

Personnel Nets

Personnel nets are designed to catch workers in unprotected areas such as bridges, buildings, towers, dams, silos, atriums, shafts, stairwells and skylights.

3M™ DBI-SALA® Adjust-A-Net™ with optional debris liner

Four basic Adjust-A-Net models fit any size or shaped work spaces. You can shrink one down for compact areas, reduce one side or the other for long, narrow applications, or snap two together for the largest areas. Adjust-A-Net personnel nets must be erected so that workers can never fall more than 25 ft. (7.5 m).

- Adjustable straps allow 50% reduction of its original size.
- 3-1/2 in. (8.75 cm) mesh size provides better protection.
- Special coating protects from UV light, resists abrasion and bonds all convergent points.
- Built-in test cords allow evaluation of integrity.
- Rugged steel snap hooks placed every 48 in. (1.2 m)
- Available attached debris liner with 1/8 in. (3.2 mm) mesh.
- Long-wearing, high-tenacity nylon is tested to 17,500 lbs. (70 kN)

Size	10 ft. x 5 ft. (3 m x 1.5 m)	10 ft. x 10 ft. (3 m x 3 m)	10 ft. x 15 ft. (3 m x 4.5 m)	15 ft. x 30 ft. (4.5 m x 9 m)	20 ft. x 40 ft. (6 m x 12 m)	25 ft. x 50 ft. (7.5 m x 15 m)	30 ft. x 60 ft. (9 m x 18 m)
No debris liner				4100100	4100101	4100102	4100103
Debris liner	4100406	4100405	4100404	4100400	4100401	4100402	4100403



4102003

Flying Form Net

These are made for today's multi-story buildings that use "flying forms" to construct concrete floors. Even though there are no tie-off anchorages above, it protects workers while they're placing the forming deck.

- One time installation.
- Passive fall arrest and debris retention.
- UV-protected nylon mesh.
- Specify custom size.



4102002

Pour-in-Place Net

Our Pour-in-Place Nets provide personnel fall protection on unprotected floor openings. They're designed to cover small voids such as stairwells, mechanical chases or elevator shafts, by being poured into the concrete. 8 ft. x 100 ft. (2.4 m x 30.5 m), no border, black. Custom sizes are available.

- Passive fall arrest and debris retention.
- Durable nylon mesh.
- Fast, easy removal.

4102001 Pour-in-Place Net, 8 ft. x 50 ft. (2.4 m x 15.4 m), no border, black

Debris Nets

Debris nets catch lightweight construction debris, tools and building materials. They prevent injury to workers, pedestrians, structures and materials below. Unlike hard hats, which protect only the head, debris nets offer protection from falling objects for the whole person. Perimeter debris nets meet OSHA and ANSI standards.

3M™ DBI-SALA® Vertical Debris Net

Its highly visible, bright orange mesh protects workers near building edges as a guardrail, and replaces mid-rail and toe boards, making it less expensive and easier to install. Designed for use with traditional cable setups, the nets are easy to remove, relocate, handle and store. Snap-on cable clips are available for easy attachment to the cables. The bottom edge of the net is quickly secured using a power tool that fires a nail into the tie-down plate.

- UV-resistant, fire-retardant.
- Exceeds OSHA's 200 lb. (90 kg) strength requirements and New York City construction codes.

Net color	Attachment kit	48 in. x 100 ft.	48 in. x 150 ft.	60 in. x 100 ft.
Orange		4100200	4100202	4100201
	■	4100300		4100301
Blue		4100204		4100205
	■	4100304		4100305

4100003 Attachment Kit, 50 clips & 20 tie-down plates

4100275 Cable Ties, 20 in. nylon, 250 lbs., 25-pack



4102000

Floor-to-Ceiling Debris Net

Our floor-to-ceiling panels provide complete containment of project debris and are strong enough to meet guardrail requirements for personnel. Debris panels are easily connected to a top and bottom cable and are reusable throughout the life of the project. Multiple floors can be protected, prior to cleanup, and then nets can be rotated upward, ahead of the cladding or glazing operations. 3-layer netting, with snap hooks, 9 ft. 6 in. tall x 30 ft. wide (2.9 m x 9.15 m).

4195436 Floor-to-Ceiling Fastener Plates, 16-pack

Custom sizing available—please call 800-326-6146.



3M™ DBI-SALA®

Rack Guard Adjustable Nets

Gray, fire-retardant with borders.

Model #480 — 4 in. x 4 in. mesh — 4,000 lb. load rating

4101575 9 ft. 4 in. x 12 ft. (2.84 m x 3.65 m)	4101579 20 ft. 8 in. x 12 ft. (6.29 m x 3.65 m)
4101576 9 ft. 4 in. x 16 ft. (2.84 m x 4.87 m)	4101583 20 ft. 8 in. x 16 ft. (6.29 m x 4.87 m)
4101577 9 ft. 4 in. x 20 ft. (2.84 m x 6.09 m)	4101585 20 ft. 8 in. x 20 ft. (6.29 m x 6.09 m)
4101578 12 ft. 4 in. x 12 ft. (3.75 m x 3.65 m)	4101580 25 ft. x 12 ft. (7.62 m x 3.65 m)
4101581 12 ft. 4 in. x 16 ft. (3.75 m x 4.87 m)	4101584 25 ft. x 16 ft. (7.62 m x 4.87 m)
4101582 12 ft. 4 in. x 20 ft. (3.75 m x 6.09 m)	4101586 25 ft. x 20 ft. (7.62 m x 6.09 m)
4101562 16 ft. 4 in. x 12 ft. (4.96 m x 3.65 m)	4101571 27 ft. 8 in. x 12 ft. (8.41 m x 3.65 m)
4101563 16 ft. 4 in. x 16 ft. (4.96 m x 4.87 m)	4101572 27 ft. 8 in. x 16 ft. (8.41 m x 4.87 m)
4101564 16 ft. 4 in. x 20 ft. (4.96 m x 6.09 m)	4101573 27 ft. 8 in. x 20 ft. (8.41 m x 6.09 m)
4101565 18 ft. 4 in. x 12 ft. (5.57 m x 3.65 m)	4101574 30 ft. 8 in. x 12 ft. (9.32 m x 3.65 m)
4101566 18 ft. 4 in. x 16 ft. (5.57 m x 4.87 m)	4101623 30 ft. 8 in. x 16 ft. (9.32 m x 4.87 m)
4101567 18 ft. 4 in. x 20 ft. (5.57 m x 6.09 m)	4101568 25 ft. x 25 ft. (7.60 m x 7.60 m)
	4101550 9 ft. 4 in. x 12 ft. (2.84 m x 3.65 m)
	4101551 9 ft. 4 in. x 16 ft. (2.84 m x 4.87 m)

Model #245 — 2 in. x 2 in. mesh — 2,500 lb. load rating

4101552 9 ft. 4 in. x 20 ft. (2.84 m x 6.09 m)	4101560 20 ft. 8 in. x 20 ft. (6.29 m x 6.09 m)
4101553 12 ft. 4 in. x 12 ft. (3.75 m x 3.65 m)	4101555 25 ft. x 12 ft. (7.62 m x 3.65 m)
4101556 12 ft. 4 in. x 16 ft. (3.75 m x 4.87 m)	4101559 25 ft. x 16 ft. (7.62 m x 4.87 m)
4101557 12 ft. 4 in. x 20 ft. (3.75 m x 6.09 m)	4101561 25 ft. x 20 ft. (7.62 m x 6.09 m)
4101587 16 ft. 4 in. x 12 ft. (4.96 m x 3.65 m)	4101596 27 ft. 8 in. x 12 ft. (8.41 m x 3.65 m)
4101588 16 ft. 4 in. x 16 ft. (4.96 m x 4.87 m)	4101597 27 ft. 8 in. x 16 ft. (8.41 m x 4.87 m)
4101589 16 ft. 4 in. x 20 ft. (4.96 m x 6.09 m)	4101598 27 ft. 8 in. x 20 ft. (8.41 m x 6.09 m)
4101590 18 ft. 4 in. x 12 ft. (5.57 m x 3.65 m)	4101599 30 ft. 8 in. x 12 ft. (9.32 m x 3.65 m)
4101591 18 ft. 4 in. x 16 ft. (5.57 m x 4.87 m)	4101621 30 ft. 8 in. x 16 ft. (9.32 m x 4.87 m)
4101592 18 ft. 4 in. x 20 ft. (5.57 m x 6.09 m)	4101622 30 ft. 8 in. x 20 ft. (9.32 m x 6.09 m)
4101554 20 ft. 8 in. x 12 ft. (6.29 m x 3.65 m)	4101593 25 ft. x 25 ft. (7.60 m x 7.60 m)
4101558 20 ft. 8 in. x 16 ft. (6.29 m x 4.87 m)	4101594 25 ft. x 30 ft. (7.60 m x 9.12 m)
	4101595 25 ft. x 36 ft. (7.60 m x 10.94 m)

Rack Hardware Kits

4101502 Flush Mount/Starter Kit (60 ft.) 1/4 in. wire cable, (4) 3/8 in. eyebolts, (8) 1/4 in. cable clamps, (4) 1/4 in. thimbles, (50) 5/16 in. snap hooks, (2-packs) 20 in. ties, (4) flush clamps
4101500 Flush Mount/Add-On Kit (60 ft.) 1/4 in. wire cable, (4) 3/8 in. eyebolts, (8) 1/4 in. cable clamps, (4) 1/4 in. thimbles, (50) 5/16 in. snap hooks, (2-packs) 20 in. ties, (2) flush clamps
4101506 Offset Mount/Starter Kit (115 ft.) 1/4 in. wire cable, (8) 3/8 in. eyebolts, (16) 1/4 in. cable clamps, (8) 1/4 in. thimbles, (100) 5/16 in. snap hooks, (1-pack) 20 in. ties, (4) offset clamps
4101505 Offset Mount/Add-On Kit (115 ft.) 1/4 in. wire cable, (8) 3/8 in. eyebolts, (16) 1/4 in. cable clamps, (8) 1/4 in. thimbles, (100) 5/16 in. snap hooks, (1-pack) 20 in. ties, (2) offset clamps
4101503 Extension Starter Kit — flush (2) extensions, (2) diagonal braces, (2) flush clamps, (2) backstay braces
4101501 Extension Add-On Kit (1) extension, (1) backstay brace
4101504 Extension Starter Kit — offset (2) extensions, (2) diagonal braces, (2) offset clamps, (2) backstay braces





3M™ DBI-SALA® Conveyor Adjustable Nets

Black, fire-retardant with borders.

Model #130 — 1 in. x 1 in. mesh — 1,000 lb. load rating

4100016 9 ft. x 25 ft. (2.74 m x 7.62 m)

4100015 9 ft. x 50 ft. (2.74 m x 15.24 m)

4100018 3 ft. x 25 ft. (0.91 m x 7.62 m)

4100017 3 ft. x 50 ft. (0.91 m x 15.24 m)

Conveyor Hardware Kits

4100020 Box Shaped Guard Kit (25 ft. or 50 ft. run) (220 ft.) 1/4 in. wire cable, (8) 3/8 in. eyebolts, (4) 3/8 in. turnbuckles, (8) 1/4 in. thimbles, (16) 1/4 in. cable clamps, (100) 5/16 in. snap hooks, (1-pack) 9 in. ties

4100019 Side Guard Kit (25 ft. or 50 ft. run) (110 ft.) 1/4 in. wire cable, (4) 3/8 in. eyebolts, (2) 3/8 in. turnbuckles, (2) 1/4 in. thimbles, (8) 1/4 in. cable clamps, (100) 5/16 in. snap hooks, (1-pack) 9 in. ties

4195161 Optional J-Guide for 5/8 in. or 1/2 in. threaded rod

Netting and Guardrails

3M™ DBI-SALA® Portable Guardrail System

This system acts as a barrier preventing personnel from falling to lower levels, thus eliminating the fall hazard. This system can protect employees with little or no training, special maintenance or gear.

- Free-standing system eliminates surface penetration.
- Built-in rail and toe board receptacles allow for infinite configurations.
- Rubber pad provides skid resistance and protects the roof surface.
- Ergonomic handles allow for easy transportation and setup.
- Fast and easy set-screw installation, insert rail and tighten.
- Corrosion-resistant construction for longevity.
- Custom colors available upon request.

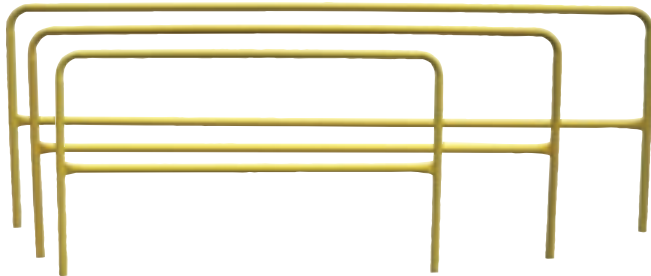

7900061

Guardrail

6 ft. (1.8 m) Guardrail Section, steel, powder coated.

7900062 8 ft. (2.4 m) Guardrail Section

7900063 10 ft. (3 m) Guardrail Section

7900067 6 ft. (1.8 m) Guardrail Section, galvanized

7900069 8 ft. (2.4 m) Guardrail Section, galvanized

7900068 10 ft. (3 m) Guardrail Section, galvanized

7900060

Guardrail Base

Galvanized Base assembly for guardrail system, 70 lbs. (32 kg)



7900005

Guardrail Splice Kit

Powder coated steel splice kit allows user to connect customized shortened rail sections together.



7900007

Guardrail Gate

Powder coated steel swing gate, adjustable from 23 in.-38 in. (58.4 cm-96.5 cm)



Guardrail Accessories

7900008

Guardrail Roof Hatch Kit

Includes: (4 ea.) 7900060 Guardrail Bases, (1 ea.) 7900007 Guardrail Gate, (3 ea.) 7900005 Guardrail Splice Kits, (3 ea.) 7900061 6 ft. (1.8 m) Rails.

7900054

Guardrail Base Transport Cart

Accommodates 4 bases (not shown).

7901000

3M™ DBI-SALA® Portable Construction Guardrail Stanchion

This system acts as a barrier, preventing personnel from falling to lower levels, thus eliminating the fall hazard. This system can protect employees with little or no training, special maintenance or gear.

- Mounts in both parapet and edge grab configurations for jobsite versatility.
- Rapid clamping system expands from 6 in.-24 in. (15.25 cm-61 cm)
- Durable zinc-plated finish for corrosion resistance and longevity.
- Supports both top and mid-rail guardrails, and toe boards when used in edge grab configuration.
- Use with standard wood 2×4's or other common guardrail materials.



Parapet configuration



Edge grab configuration

Part Number and Page Index

SKU	Page #	SKU	Page #	SKU	Page #
1000002	44	1002010	130	1102008	37
1000003	44	1002103	130	1102010	39
1000004	44	1002106	130	1102090	37
1000005	44	1002200	130	1102201	38
1000022	44	1002201	130	1102340	33
1000023	44	1002202	130	1102341	33
1000024	44	1003000	130	1102342	33
1000025	44	1003006	130	1102343	33
1000052	44	1003220	24, 43	1102385	33
1000053	44	1003221	24, 43	1102386	33
1000054	44	1003222	24	1102387	33
1000055	44	1003230	24	1102388	33
1000162	44	1100300	32	1102950	39
1000163	44	1100301	32	1103070	27
1000164	44	1100302	32	1103071	27
1000165	44	1100303	32	1103072	27
1000542	43	1100517	35	1103073	27
1000543	43	1100518	35	1103085	27
1000544	43	1100519	35	1103086	27
1000545	43	1100523	35	1103087	27
1000570	24, 32, 43	1100530	33	1103088	27
1000572	24	1100531	33	1103270	39
1000573	24	1100532	33	1103321	37
1000708	44	1100533	33	1103350	40
1000709	44	1100636	35	1103351	40
1000716	44	1100637	35	1103352	40
1000717	44	1100638	35	1103355	40
1001001	44	1100639	35	1103375	39
1001002	44	1100745	35	1103512	38
1001003	44	1100746	35	1103513	38
1001004	44	1100747	35	1103525	38
1001005	44	1100748	35	1103526	38
1001090	44	1100784	41	1103875	37
1001140	44	1100785	35	1104625	42
1001190	44	1100786	35	1104725	37
1001210	175	1100787	35	1104775	42
1001220	175	1100788	35	1105475	42
1001378	44	1100795	35	1105825	43
1001379	29	1100796	35	1105826	43
1001380	29	1100797	35	1105827	43
1001381	29	1100798	35	1105828	43
1001382	29	1100821	35	1106106	43
1001383	29	1100822	35	1106107	43
1001384	29	1100823	35	1106108	43
1001385	29	1100824	35	1106112	43
1001386	29	1100935	35	1106350	43
1001387	29	1100936	35	1106353	43
1001388	29	1100937	35	1106354	43
1001389	29	1100938	35	1106357	43
1001390	29	1100945	35	1106403	40
1001391	29	1100946	35	1106404	40
1001392	29	1100947	35	1106405	40
1001393	29	1100948	35	1106408	40
1001394	29	1101254	37	1106450	40
1001395	29	1101654	38	1106451	40
1001396	29	1101655	38	1106452	40
1001397	29	1101656	38	1106453	40
1001398	29	1101781	37	1107404	42
1001399	29	1101809	39	1107416	42
1001400	29	1101810	39	1107420	42
1001401	29	1101811	39	1107775	40
1001402	29	1101812	39	1107776	40
1001403	29	1102000	37	1107777	40
1001404	29	1102001	37	1107778	40

SKU	Page #	SKU	Page #	SKU	Page #
1107801.....	38	1110625.....	37	1112565.....	17
1107802.....	38	1110700.....	39	1112566.....	17
1107805.....	38	1110725.....	39	1112567.....	17
1107807.....	37	1110750.....	40	1112568.....	17
1107809.....	38	1110751.....	40	1112580.....	17
1107975.....	31	1110752.....	40	1112581.....	17
1107976.....	31	1110754.....	40	1112582.....	17
1107977.....	31	1110773.....	41	1112583.....	17
1107981.....	31	1110774.....	41	1112585.....	17
1108125.....	43	1110780.....	40	1112586.....	17
1108126.....	43	1110781.....	40	1112587.....	17
1108127.....	43	1110782.....	40	1112588.....	17
1108128.....	43	1110783.....	41	1113001.....	21
1108500.....	32	1110788.....	40	1113004.....	21
1108501.....	32	1110820.....	41	1113007.....	21
1108502.....	32	1110830.....	41	1113010.....	21
1108507.....	32	1110940.....	41	1113031.....	21
1108516.....	32	1110990.....	42	1113034.....	21
1108517.....	32	1111576.....	42	1113037.....	21
1108518.....	32	1111580.....	42	1113040.....	21
1108519.....	32	1111584.....	42	1113046.....	21
1108525.....	31	1112126.....	37	1113049.....	21
1108526.....	31	1112475.....	18	1113052.....	21
1108527.....	31	1112476.....	18	1113055.....	21
1108532.....	31	1112477.....	18	1113061.....	21
1108575.....	31	1112478.....	18	1113064.....	21
1108576.....	31	1112479.....	18	1113067.....	21
1108577.....	31	1112480.....	18	1113070.....	21
1108581.....	31	1112481.....	18	1113076.....	21
1108600.....	31	1112482.....	18	1113079.....	21
1108601.....	31	1112483.....	18	1113082.....	21
1108602.....	31	1112484.....	18	1113085.....	21
1108606.....	31	1112490.....	18	1113091.....	21
1108650.....	33	1112491.....	18	1113094.....	21
1108651.....	33	1112492.....	18	1113097.....	21
1108652.....	33	1112493.....	18	1113100.....	21
1108657.....	33	1112494.....	18	1113106.....	21
1108675.....	31	1112500.....	18	1113109.....	21
1108676.....	31	1112501.....	18	1113112.....	21
1108677.....	31	1112502.....	18	1113115.....	21
1108682.....	31	1112503.....	18	1113121.....	22
1108700.....	31	1112504.....	18	1113124.....	22
1108701.....	31	1112520.....	18	1113127.....	22
1108702.....	31	1112521.....	18	1113130.....	22
1108706.....	31	1112522.....	18	1113136.....	22
1108975.....	32	1112523.....	18	1113139.....	22
1108977.....	32	1112524.....	18	1113142.....	22
1108978.....	32	1112530.....	18	1113145.....	22
1108979.....	32	1112531.....	18	1113151.....	22
1109355.....	31	1112532.....	18	1113154.....	22
1109356.....	31	1112533.....	18	1113157.....	22
1109357.....	31	1112534.....	18	1113160.....	22
1109358.....	31	1112535.....	17	1113190.....	22
1109975.....	42	1112536.....	17	1113191.....	22
1110475.....	32	1112537.....	17	1113192.....	22
1110476.....	32	1112538.....	17	1113193.....	22
1110477.....	32	1112540.....	17	1113195.....	23
1110478.....	32	1112541.....	17	1113196.....	23
1110575.....	38	1112542.....	17	1113197.....	23
1110576.....	38	1112543.....	17	1113199.....	23
1110577.....	38	1112550.....	17	1113210.....	23
1110578.....	38	1112551.....	17	1113211.....	23
1110600.....	37	1112552.....	17	1113212.....	23
1110602.....	37	1112553.....	17	1113213.....	23

SKU	Page #	SKU	Page #	SKU	Page #
1113215	23	1113608	29	1219006	191
1113216	23	1113675	29	1219007	191
1113217	23	1113676	29	1219020	191
1113218	23	1113677	29	1231016	84
1113285	24	1113678	29	1231102	84
1113286	24	1113681	29	1231103	84
1113287	24	1113682	29	1231104	84
1113288	24	1113683	29	1231106	84
1113290	24	1113684	29	1231117	45
1113291	24	1113688	29	1231305	135
1113292	24	1113689	29	1231380	84
1113293	24	1113690	29	1231389	84
1113295	24	1113691	29	1231460	175
1113296	24	1113692	29	1231470	175
1113297	24	1113693	29	1231520	84
1113298	24	1113757	29	1232209	84
1113305	24	1113758	29	1232210	84
1113306	24	1113759	29	1232306	84
1113307	24	1113760	29	1232354	84
1113308	24	1113761	29	1234070	85
1113315	27	1113762	29	1234071	85
1113316	27	1113763	29	1234080	85, 190
1113317	27	1113764	29	1234081	190
1113318	27	1113768	29	1234083	85
1113325	27	1113774	29	1241460	81
1113326	27	1113781	29	1241461	81
1113327	27	1113786	29	1241462	81
1113328	27	1150037	45	1241480	81
1113330	27	1150054	41	1241481	81
1113331	27	1150058	41	1241482	81
1113332	27	1150143	45	1244306	76
1113333	27	1150144	45	1244310	77
1113335	27	1150174	45	1244311	76
1113336	27	1200110	85	1244321	76
1113337	27	1200111	85	1244360	76
1113338	27	1200115	85	1244406	76
1113345	25	1200136	85	1244409	76
1113346	25	1201390	130	1244412	76
1113347	25	1201391	130	1244420	77
1113348	25	1201421	130	1244448	76
1113357	27	1202739	113	1244455	77
1113358	27	1202740	113	1244456	77
1113368	27	1202742	113	1244459	77
1113369	27	1202750	113	1244610	77
1113370	25	1202753	113	1244611	77
1113371	25	1202754	113	1244630	77
1113372	25	1202785	113	1244631	77
1113373	25	1202790	113	1244632	77
1113449	110	1202794	113	1244639	77
1113450	110	1202818	113	1244650	77
1113451	110	1202821	113	1244675	77
1113452	110	1202823	113	1244750	77
1113453	110	1202838	113	1244751	77
1113454	110	1202842	113	1246011	78
1113455	110	1202844	113	1246021	78
1113456	110	1202877	113	1246022	78
1113457	110	1202878	113	1246024	78
1113458	110	1202879	113	1246030	83
1113490	27	1204057	85	1246032	83
1113491	27	1204058	85	1246037	112
1113492	27	1204074	85	1246040	79
1113493	27	1204075	85	1246041	79
1113595	29	1204076	85	1246042	79
1113601	29	1204077	85	1246043	79

SKU	Page #	SKU	Page #	SKU	Page #
1246044.....	79	1500003.....	48	1500071.....	70
1246045.....	79	1500004.....	48	1500072.....	70
1246046.....	79	1500005.....	48	1500073.....	70
1246047.....	79	1500006.....	48	1500074.....	70
1246048.....	79	1500007.....	48	1500075.....	70
1246049.....	79	1500008.....	48	1500076.....	70
1246050.....	79	1500009.....	51	1500077.....	70
1246060.....	79	1500010.....	52	1500078.....	70
1246061.....	79	1500011.....	50	1500079.....	70
1246066.....	80	1500012.....	50	1500080.....	70
1246068.....	80	1500013.....	50	1500081.....	70
1246070.....	79	1500014.....	50	1500082.....	71
1246071.....	79	1500015.....	50	1500083.....	71
1246072.....	79	1500016.....	50	1500084.....	71
1246075.....	83	1500017.....	50	1500085.....	71
1246080.....	83	1500018.....	50	1500086.....	71
1246085.....	79	1500019.....	51	1500087.....	71
1246088.....	79	1500020.....	51	1500088.....	61
1246089.....	79	1500021.....	51	1500089.....	61
1246100.....	78	1500022.....	51	1500090.....	62
1246101.....	78	1500023.....	51	1500091.....	61
1246103.....	78	1500024.....	53	1500092.....	61
1246104.....	81	1500025.....	53	1500093.....	61
1246113.....	78	1500026.....	53	1500094.....	61
1246130.....	82	1500027.....	52	1500095.....	60
1246143.....	82	1500028.....	52	1500096.....	60
1246145.....	82	1500029.....	52	1500097.....	60
1246147.....	82	1500030.....	52	1500098.....	60
1246151.....	83	1500031.....	52	1500099.....	60
1246152.....	83	1500032.....	52	1500100.....	60
1246153.....	83	1500033.....	52	1500101.....	59
1246159.....	82	1500034.....	52	1500102.....	59
1246161.....	82	1500035.....	49	1500103.....	59
1246167.....	82	1500036.....	49	1500104.....	59
1246173.....	83	1500037.....	49	1500105.....	59
1246177.....	78	1500038.....	49	1500106.....	59
1246178.....	80	1500039.....	49	1500107.....	59
1246181.....	78	1500040.....	49	1500108.....	59
1246188.....	78	1500044.....	49	1500109.....	59
1246193.....	78	1500045.....	49	1500110.....	63
1246196.....	78	1500046.....	49	1500111.....	63
1246200.....	78	1500047.....	54	1500112.....	63
1246203.....	79	1500048.....	54	1500113.....	63
1246208.....	83	1500049.....	54	1500114.....	63
1246213.....	79	1500050.....	56	1500115.....	63
1246226.....	79	1500051.....	57	1500116.....	63
1246229.....	83	1500052.....	57	1500117.....	63
1246234.....	78	1500053.....	56	1500118.....	63
1246261.....	80	1500054.....	56	1500119.....	64
1246272.....	82	1500055.....	56	1500120.....	64
1246273.....	82	1500056.....	56	1500121.....	64
1246306.....	80	1500057.....	56	1500122.....	64
1246307.....	80	1500058.....	56	1500123.....	64
1246310.....	80	1500059.....	55	1500124.....	65
1246311.....	80	1500060.....	55	1500125.....	65
1246317.....	80	1500061.....	55	1500126.....	65
1246318.....	80	1500062.....	55	1500127.....	65
1246320.....	80	1500063.....	55	1500128.....	65
1246321.....	80	1500064.....	55	1500129.....	65
1246324.....	80	1500065.....	55	1500130.....	65
1246352.....	80	1500066.....	55	1500131.....	65
1270035.....	190	1500067.....	55	1500132.....	65
1500001.....	48	1500068.....	55	1500133.....	67
1500002.....	48	1500070.....	70	1500134.....	66, 67

SKU	Page #	SKU	Page #	SKU	Page #
1500135.....	68	2104800.....	139	3101498.....	91
1500136.....	69	2104801.....	139	3101499.....	91
1500137.....	69	2104810.....	139	3101500.....	91
1500138.....	69	2104816.....	137	3101501.....	91
1500139.....	67	2105500.....	135	3101502.....	91
1500140.....	66, 67	2105682.....	138	3101503.....	91
1500141.....	68	2105683.....	138	3101504.....	91
2000025.....	187	2108403.....	84	3101505.....	91
2000112.....	183	2108406.....	132	3101526.....	91
2000114.....	183, 187	2108407.....	132	3101527.....	91
2000117.....	187	2108408.....	132	3101528.....	91
2000171.....	187	2108410.....	132	3101529.....	91
2000172.....	187	2110941.....	132	3101530.....	91
2100050.....	134	2189983.....	186	3101531.....	91
2100066.....	134	2189996.....	186	3101532.....	91
2100080.....	139	2189997.....	186	3101533.....	91
2100085.....	134	2189998.....	186	3101534.....	91
2100090.....	139	2189999.....	186	3101535.....	91
2100091.....	139	2200048.....	141	3101536.....	91
2100101.....	134	2200078.....	141	3101537.....	91
2100133.....	137	2200094.....	141	3101538.....	91
2100138.....	138	2200095.....	141	3101539.....	91
2100139.....	138	2200096.....	141	3101540.....	91
2100140.....	138	2200107.....	141	3101562.....	91
2100142.....	138	2200108.....	141	3101563.....	91
2100152.....	134	2200109.....	141	3101565.....	91
2100154.....	131	2200122.....	141	3101574.....	91
2100155.....	131	2200123.....	141	3101575.....	91
2100156.....	131	2200130.....	141	3101582.....	90
2100169.....	134	2200180.....	141	3101586.....	90
2100171.....	131	2200181.....	141	3101590.....	90
2100172.....	131	2200401.....	141	3101621.....	90
2100185.....	137	3101001.....	98	3101624.....	90
2101000.....	134	3101006.....	98	3101625.....	90
2101002.....	134	3101009.....	98	3102000.....	99
2101004.....	134	3101215.....	89	3102003.....	99
2101630.....	133	3101225.....	89	3102100.....	99
2101634.....	133	3101227.....	89	3102115.....	99
2101636.....	133	3101228.....	89	3103107.....	97
2101638.....	133	3101229.....	89	3103108.....	97
2103143.....	133	3101254.....	89	3103110.....	97
2103147.....	133	3101273.....	89	3103119.....	97
2103189.....	186	3101277.....	89	3103120.....	97
2103670.....	137	3101279.....	89	3103136.....	97
2103671.....	137	3101280.....	89	3103175.....	97
2103673.....	137	3101288.....	89	3103176.....	97
2103675.....	137	3101300.....	98	3103207.....	97
2103677.....	137	3101322.....	91	3103208.....	97
2103690.....	138	3101324.....	91	3103209.....	97
2104168.....	136	3101326.....	91	3103212.....	97
2104169.....	136	3101365.....	90	3103214.....	97
2104190.....	137	3101366.....	90	3103275.....	97
2104527.....	139	3101367.....	90	3302002.....	184
2104528.....	139	3101368.....	90	3303000.....	184
2104529.....	139	3101373.....	90	3303001.....	184
2104530.....	139	3101374.....	90	3303002.....	184
2104531.....	139	3101473.....	89	3303003.....	184
2104541.....	137	3101491.....	91	3303015.....	184
2104542.....	137	3101492.....	91	3303016.....	184
2104550.....	133, 171	3101493.....	91	3303017.....	184
2104560.....	134	3101494.....	91	3303018.....	184
2104561.....	134	3101495.....	91	3303019.....	184
2104562.....	134	3101496.....	91	3303021.....	184
2104700.....	132	3101497.....	91	3320003.....	183

SKU	Page #	SKU	Page #	SKU	Page #
3320014.....	182, 183	3500100.....	181	3699954.....	186
3320030.....	179	3500101.....	181	3699997.....	186
3320031.....	179	3500102.....	181	3699998.....	186
3320037.....	179	3500200.....	181	3900105.....	95
3325100.....	183	3500201.....	181	3900107.....	95
3325200.....	183	3500202.....	181	3900108.....	95
3325275.....	183	3500210.....	93	3900111.....	95
3325300.....	183	3500211.....	93	3900112.....	95
3326100.....	183	3500212.....	93	3900114.....	95
3326300.....	183	3500213.....	93	4100003.....	197
3326350.....	183	3500214.....	93	4100005.....	195
3327050.....	183	3500215.....	93	4100006.....	195
3327100.....	183	3500216.....	93	4100007.....	195
3327150.....	183	3500225.....	93	4100015.....	199
3327200.....	183	3500226.....	93	4100016.....	199
3327275.....	183	3500227.....	93	4100017.....	199
3327300.....	183	3500228.....	93	4100018.....	199
3327325.....	183	3500229.....	93	4100019.....	199
3327350.....	183	3500230.....	93	4100020.....	199
3327400.....	183	3500231.....	93	4100047.....	195
3327450.....	183	3500246.....	93	4100089.....	195
3327500.....	183	3500247.....	93	4100091.....	195
3400650.....	95	3500248.....	93	4100092.....	195
3400652.....	95	3500249.....	93	4100093.....	195
3400660.....	95, 174	3501102.....	97, 174	4100100.....	196
3400661.....	95, 174	3501103.....	174	4100101.....	196
3400800.....	95	3504422.....	97	4100102.....	196
3400802.....	95	3504430.....	97	4100103.....	196
3400825.....	95	3504431.....	97	4100139.....	195
3400827.....	95	3504432.....	97	4100140.....	195
3400850.....	95, 174	3504433.....	97	4100141.....	195
3400852.....	95, 174	3504434.....	97	4100151.....	195
3400853.....	95, 174	3504437.....	97	4100153.....	195
3400858.....	95, 174	3504438.....	97	4100155.....	195
3400860.....	95	3504445.....	97	4100156.....	195
3400862.....	95	3504446.....	97	4100157.....	195
3400870.....	95, 174	3504450.....	97	4100200.....	197
3400871.....	95, 174	3504451.....	97	4100201.....	197
3400874.....	95, 174	3504452.....	97	4100202.....	197
3400882.....	95, 174	3504463.....	97	4100204.....	197
3400885.....	95	3504480.....	97	4100205.....	197
3400886.....	95, 180	3504485.....	97	4100275.....	197
3400900.....	95	3504486.....	97	4100300.....	197
3400902.....	95	3504487.....	97	4100301.....	197
3400910.....	95, 174	3504500.....	97	4100304.....	197
3400912.....	95, 174	3504550.....	97, 180	4100305.....	197
3400920.....	95, 174	3504551.....	97	4100400.....	196
3400922.....	95, 174	3504552.....	97, 180	4100401.....	196
3400923.....	95, 174	3504600.....	97	4100402.....	196
3400926.....	174	3505694.....	138	4100403.....	196
3400930.....	95, 180	3505695.....	138	4100404.....	196
3400932.....	95, 180	3511063.....	111	4100405.....	196
3400940.....	95, 174	3511598.....	111	4100406.....	196
3400942.....	95, 174	3511645.....	111	4101500.....	198
3400965.....	95	3511783.....	111	4101501.....	198
3400967.....	95	3512000.....	111	4101502.....	198
3400975.....	95, 174	3530000.....	111	4101503.....	198
3400976.....	95, 174	3601490.....	185	4101504.....	198
3400979.....	95, 174	3602050.....	184	4101505.....	198
3400987.....	95, 174	3602100.....	184	4101506.....	198
3400990.....	95	3620004.....	183	4101550.....	198
3400991.....	95, 180	3620005.....	183	4101551.....	198
3401002.....	95, 174	3699952.....	186	4101552.....	198
3401004.....	95, 174	3699953.....	186	4101553.....	198

SKU	Page #	SKU	Page #	SKU	Page #
4101554.....	198	5901583.....	113	7400054.....	117
4101555.....	198	5901980.....	105	7400055.....	117
4101556.....	198	5920050.....	84	7400056.....	117
4101557.....	198	5920051.....	84	7400057.....	117
4101558.....	198	5920059.....	84	7400073.....	117
4101559.....	198	5920080.....	84	7400086.....	117
4101560.....	198	5920101.....	84	7400087.....	117
4101561.....	198	6000031.....	107	7400089.....	117
4101562.....	198	6000032.....	107	7400200.....	120
4101563.....	198	6000033.....	107	7400201.....	120
4101564.....	198	6000100.....	107	7400203.....	120
4101565.....	198	6000120.....	107	7400211.....	120
4101566.....	198	6000132.....	107	7400214.....	117
4101567.....	198	6000298.....	107	7400215.....	117
4101568.....	198	6000301.....	107	7400218.....	120
4101571.....	198	6000302.....	107	7400220.....	120
4101572.....	198	6000303.....	107	7400222.....	120
4101573.....	198	6000304.....	107	7400225.....	120
4101574.....	198	6000306.....	107	7400230.....	120
4101575.....	198	6000307.....	107	7400240.....	120
4101576.....	198	6000352.....	107	7400250.....	120
4101577.....	198	6000354.....	107	7400260.....	120
4101578.....	198	6000375.....	107	7400320.....	117
4101579.....	198	6000377.....	107	7400330.....	117
4101580.....	198	6100031.....	110	7400340.....	117
4101581.....	198	6100035.....	104	7400350.....	117
4101582.....	198	6100045.....	104	7400360.....	117
4101583.....	198	6100090.....	103	7400420.....	116
4101584.....	198	6100136.....	104	7400430.....	116
4101585.....	198	6100140.....	104	7400440.....	116
4101586.....	198	6100400.....	103	7400450.....	116
4101587.....	198	6100515.....	103	7400460.....	116
4101588.....	198	6110000.....	104	7400620.....	116
4101589.....	198	6116026.....	105	7400630.....	116
4101590.....	198	6116027.....	105	7400640.....	116
4101591.....	198	6116038.....	105	7400650.....	116
4101592.....	198	6116054.....	105	7400660.....	116
4101593.....	198	6116224.....	104	7401013.....	120
4101594.....	198	6116280.....	103	7401031.....	120
4101595.....	198	6116336.....	105	7401032.....	120
4101596.....	198	6116410.....	103	7401033.....	120
4101597.....	198	6147000.....	105	7600002.....	118
4101598.....	198	6160024.....	110	7600502.....	119
4101599.....	198	6160026.....	110	7600503.....	119
4101621.....	198	6160027.....	110	7600504.....	119
4101622.....	198	6160028.....	110	7600505.....	119
4101623.....	198	6160030.....	103	7600506.....	119
4102000.....	197	6160039.....	110	7600507.....	119
4102001.....	196	6160040.....	110	7600508.....	119
4102002.....	196	6160041.....	110	7600509.....	119
4102003.....	196	6160051.....	110	7600510.....	119
4195161.....	199	6160054.....	103, 104	7600511.....	136
4195436.....	197	7200439.....	137	7600580.....	120
5000335.....	112	7241182.....	138	7602020.....	119
5000338.....	112	7241183.....	138	7602030.....	119
5000400.....	113	7241204.....	138	7602040.....	119
5000401.....	113	7241206.....	138	7602050.....	119
5001442.....	112	7241208.....	138	7602060.....	119
5002045.....	112	7400001.....	117	7602070.....	119
5900550.....	130	7400008.....	117	7602080.....	119
5900551.....	130	7400045.....	117	7602090.....	119
5900552.....	130	7400047.....	117	7602100.....	119
5900891.....	45	7400052.....	117	7603020.....	121
5900892.....	45	7400053.....	117	7603040.....	121

SKU	Page #	SKU	Page #	SKU	Page #
7603060.....	121	8512292.....	169	8517795.....	149
7603070.....	121	8512293.....	169	8517796.....	149
7603073.....	121	8512827.....	161	8517797.....	149
7603076.....	121	8512828.....	161	8517798.....	149
7603079.....	121	8512829.....	165	8518000.....	163
7603080.....	121	8512831.....	161	8518001.....	159
7603100.....	121	8512894.....	166	8518002.....	159
7603120.....	121	8512935.....	175	8518003.....	159
7603140.....	121	8512936.....	175	8518004.....	159
7603160.....	121	8512994.....	165	8518005.....	164
7603180.....	121	8513158.....	169	8518006.....	159
7605060.....	118	8513159.....	168	8518008.....	164
7608001.....	121	8513329.....	169, 171	8518040.....	163
7608002.....	121	8513330.....	159, 169, 171	8518270.....	163
7608008.....	120	8513564.....	159	8518347.....	161
7611904.....	136	8513565.....	164	8518348.....	161
7611907.....	136	8514461.....	165	8518382.....	159
7900005.....	200	8514496.....	166	8518383.....	159
7900007.....	200	8514503.....	165	8518384.....	159
7900008.....	200	8515150.....	170	8518385.....	159
7900054.....	200	8515162.....	161	8518386.....	159
7900060.....	200	8515631.....	170	8518387.....	159
7900061.....	200	8515834.....	161	8518506.....	175
7900062.....	200	8516190.....	161	8518507.....	175
7900063.....	200	8516191.....	161	8518508.....	175
7900067.....	200	8516294.....	185	8518509.....	159
7900068.....	200	8516316.....	185	8518513.....	163
7900069.....	200	8516563.....	161	8518558.....	174
7901000.....	201	8516691.....	172	8518559.....	174
8000000.....	169	8516692.....	172	8518560.....	174
8000010.....	169	8516693.....	172	8518561.....	174
8102001.....	174	8516824.....	175	8518564.....	174
8102003.....	174	8516996.....	172	8518565.....	174
8102005.....	174	8516997.....	172	8518566.....	174
8102007.....	174	8517412.....	172	8518567.....	174
8102009.....	174	8517413.....	172	8518568.....	174
8102011.....	174	8517565.....	172	8518571.....	174
8102050.....	174	8517567.....	175	8518579.....	174
8510057.....	161	8517701.....	148	8518580.....	174
8510109.....	161	8517705.....	148	8518581.....	174
8510110.....	161	8517707.....	148	8518582.....	174
8510140.....	165	8517709.....	148	8518586.....	174
8510163.....	165	8517711.....	148	8518587.....	174
8510207.....	175	8517713.....	148	8518588.....	174
8510224.....	169	8517715.....	150	8518589.....	174
8510311.....	161	8517717.....	150	8518601.....	174
8510316.....	161	8517719.....	150	8518602.....	174
8510323.....	164	8517750.....	145	8518603.....	174
8510429.....	164	8517751.....	145	8518604.....	174
8510457.....	165	8517752.....	145	8518608.....	174
8510501.....	165	8517753.....	145	8518609.....	174
8510520.....	165	8517754.....	145	8518610.....	174
8510546.....	165	8517755.....	145	8518611.....	174
8510568.....	164	8517760.....	147	8519377.....	164
8510632.....	165	8517761.....	147	8520775.....	167
8510633.....	165	8517762.....	147	8520777.....	171
8510715.....	164	8517763.....	147	8523178.....	135
8510816.....	172	8517780.....	149	8530088.....	167
8510826.....	161	8517781.....	149	8530152.....	151
8510827.....	161	8517790.....	149	8530161.....	151
8511384.....	165	8517791.....	149	8530162.....	151
8511401.....	165	8517792.....	149	8530210.....	151
8511892.....	167	8517793.....	149	8530252.....	171
8512285.....	164	8517794.....	149	8530253.....	171

SKU	Page #	SKU	Page #	SKU	Page #
8530256.....	167	8700167.....	187	8705116.....	188
8530257.....	170	8700168.....	187	8705117.....	188
8530267.....	120	8700198.....	187	8705118.....	188
8530288.....	153	8700200.....	187	8705119.....	188
8530314.....	151	8700201.....	187	8705120.....	188
8530320.....	151	8700222.....	190	8705122.....	188
8530345.....	153	8700223.....	190	8705123.....	188
8530361.....	153	8700224.....	190	8705124.....	188
8530387.....	151	8700225.....	190	8705125.....	188
8530397.....	152	8700302.....	190	8705126.....	188
8530427.....	153	8700387.....	186	8705127.....	188
8530433.....	145	8700388.....	186	8800023.....	133
8530538.....	146	8700397.....	191	8900249.....	191
8530557.....	146	8700398.....	191	8900292.....	185
8530558.....	146	8700425.....	187	8900293.....	185
8530559.....	146	8700522.....	191	8900294.....	185
8530564.....	146	8700523.....	191	8900299.....	179, 183
8530565.....	146	8700524.....	191	8902004.....	184
8530566.....	146	8700528.....	189	8902006.....	184
8530571.....	146	8700561.....	187	9500468.....	45
8530579.....	144	8700600.....	188	9501207.....	45
8530595.....	144	8700601.....	188	9501403.....	45
8530606.....	144	8700602.....	188	9502006.....	45
8530607.....	144	8700603.....	188	9503094.....	169
8530619.....	144	8700604.....	188	9503095.....	169
8530620.....	144	8700605.....	188	9504733.....	183
8530621.....	146	8700606.....	188	9505504.....	45
8700012.....	189	8700607.....	188	9505515.....	45
8700013.....	189	8701100.....	190	9505712.....	45
8700014.....	189	8701101.....	190	9506162.....	183
8700015.....	189	8701102.....	190	9506929.....	110
8700017.....	189	8702098.....	190	9508289.....	183
8700018.....	189	8702099.....	190	9509238.....	187
8700021.....	189	8702100.....	190	9511597.....	45
8700022.....	189	8704104.....	190	9600003.....	110
8700039.....	189	8704105.....	190	9600068.....	110
8700053.....	189	8704107.....	190	9600069.....	110
8700057.....	189	8704108.....	190	AC202D/0.....	183
8700141.....	190	8705104.....	190		
8700142.....	190	8705105.....	190		
8700144.....	191	8705115.....	188		

▲WARNING

Compliant fall protection and emergency rescue systems help prevent serious injuries associated with fall events. Users must read and understand the User Instructions provided with the product, and must be properly trained by their employers in the safe use of these systems before using them, per OSHA 1910.66 and 1926.503 or applicable local standards. Misuse or failure to follow warnings and instructions may result in serious personal injury or death. For proper use, see supervisor, User Instructions, or call 800-328-6146 (Opt. 1).

Notes



3M Fall Protection Business

Personal Safety Division
3833 SALA Way
Red Wing, MN 55066 USA

Phone 800-328-6146
Email 3mfallprotection@mmm.com
Web 3M.com/FallProtection

3M and DBI-SALA are trademarks of 3M.
© 3M 2016.
9700505 Rev D